

Table of Contents

Introduction	4
Instrument Cluster	12
Warning lights and chimes	12
Gauges	19
Entertainment Systems	22
How to get going	22
AM/FM stereo	26
AM/FM stereo with CD	28
AM/FM stereo with in-dash six CD	34
Auxiliary input jack	41
Satellite radio information	45
Climate Controls	48
Heater only	48
Manual heating and air conditioning	49
Automatic temperature control	51
Rear window defroster	57
Lights	58
Headlamps	58
Turn signal control	61
Bulb replacement	63
Driver Controls	68
Windshield wiper/washer control	68
Steering wheel adjustment	68
Power windows	74
Mirrors	77
Speed control	79
Message center	89
Tailgate	98

Table of Contents

Locks and Security	101
Keys	101
Locks	101
Anti-theft system	112
Seating and Safety Restraints	115
Seating	115
Safety restraints	121
Airbags	140
Child restraints	149
Tires, Wheels and Loading	167
Tire information	169
Tire inflation	171
Tire Pressure Monitoring System (TPMS)	184
Vehicle loading	188
Trailer towing	194
Recreational towing	206
Driving	208
Starting	208
Brakes	212
Traction Control™	215
Transmission operation	217
Roadside Emergencies	241
Getting roadside assistance	241
Hazard flasher switch	243
Fuel pump shut-off switch	243
Fuses and relays	244
Changing tires	252
Lug nut torque	259
Jump starting	259
Wrecker towing	265

Table of Contents

Customer Assistance	266
Reporting safety defects (U.S. only)	272
Cleaning	273
Maintenance and Specifications	283
Engine compartment	285
Engine oil	289
Battery	293
Engine coolant	295
Fuel information	301
Air filter(s)	320
Part numbers	322
Maintenance product specifications and capacities	324
Engine data	328
Accessories	332
Index	334

All rights reserved. Reproduction by any means, electronic or mechanical including photocopying, recording or by any information storage and retrieval system or translation in whole or part is not permitted without written authorization from Ford Motor Company. Ford may change the contents without notice and without incurring obligation.

Copyright © 2006 Ford Motor Company

Introduction

CALIFORNIA Proposition 65 Warning



WARNING: Engine exhaust, some of its constituents, and certain vehicle components contain or emit chemicals known to the State of California to cause cancer and birth defects or other reproductive harm. In addition, certain fluids contained in vehicles and certain products of component wear contain or emit chemicals known to the State of California to cause cancer and birth defects or other reproductive harm.

CONGRATULATIONS

Congratulations on acquiring your new Ford. Please take the time to get well acquainted with your vehicle by reading this handbook. The more you know and understand about your vehicle, the greater the safety and pleasure you will derive from driving it.

For more information on Ford Motor Company and its products visit the following website:

- In the United States: www.ford.com
- In Canada: www.ford.ca
- In Australia: www.ford.com.au
- In Mexico: www.ford.com.mx

Additional owner information is given in separate publications.

This *Owner's Guide* describes every option and model variant available and therefore some of the items covered may not apply to your particular vehicle. Furthermore, due to printing cycles it may describe options before they are generally available.

Remember to pass on this *Owner's Guide* when reselling the vehicle. It is an integral part of the vehicle.



Fuel pump shut-off switch: In the event of an accident the safety switch will automatically cut off the fuel supply to the engine. The switch can also be activated through sudden vibration (e.g. collision when parking). To reset the switch, refer to the *Fuel pump shut-off switch* in the *Roadside Emergencies* chapter.

SAFETY AND ENVIRONMENT PROTECTION

Warning symbols in this guide

How can you reduce the risk of personal injury to yourself or others? In this guide, answers to such questions are contained in comments highlighted by the warning triangle symbol. These comments should be read and observed.

Warning symbols on your vehicle

When you see this symbol, it is imperative that you consult the relevant section of this guide before touching or attempting adjustment of any kind.



Protecting the environment

We must all play our part in protecting the environment. Correct vehicle usage and the authorized disposal of waste, cleaning and lubrication materials are significant steps towards this aim. Information in this respect is highlighted in this guide with the tree symbol.



Introduction

BREAKING-IN YOUR VEHICLE

Your vehicle does not need an extensive break-in. Try not to drive continuously at the same speed for the first 1,000 miles (1,600 km) of new vehicle operation. Vary your speed frequently in order to give the moving parts a chance to break in.

Drive your new vehicle at least 500 miles (800 km) before towing a trailer. Additionally, during the first 500 miles (800 km) that you tow a trailer, do not drive over 70 mph (112 km/h) and do not make starts at full throttle. This style of driving will help the engine and other parts of your vehicle break in at the heavier loads. For more detailed information about towing a trailer, refer to *Trailer towing* in the *Tires, Wheels and Loading* chapter.

Do not add friction modifier compounds or special break-in oils during the first few thousand miles (kilometers) of operation, since these additives may prevent piston ring seating. See *Engine oil* in the *Maintenance and Specifications* chapter for more information on oil usage.

SPECIAL NOTICES

New Vehicle Limited Warranty

For a detailed description of what is covered and what is not covered by your vehicle's New Vehicle Limited Warranty, refer to the *Warranty Guide* that is provided to you along with your *Owner's Guide*.

Introduction

Special instructions

For your added safety, your vehicle is fitted with sophisticated electronic controls.



Please read the section *Supplemental restraint system (SRS)* in the *Seating and Safety Restraints* chapter. Failure to follow the specific warnings and instructions could result in personal injury.



Front seat mounted rear-facing child or infant seats should **NEVER** be placed in front of an active passenger airbag.

Service Data Recording

Service data recorders in your vehicle are capable of collecting and storing diagnostic information about your vehicle. This potentially includes information about the performance or status of various systems and modules in the vehicle, such as engine, throttle, steering or brake systems. In order to properly diagnose and service your vehicle, Ford Motor Company, Ford of Canada, and service and repair facilities may access vehicle diagnostic information through a direct connection to your vehicle when diagnosing or servicing your vehicle.

Event Data Recording

Other modules in your vehicle — event data recorders — are capable of collecting and storing data during a crash or near crash event. The recorded information may assist in the investigation of such an event. The modules may record information about both the vehicle and the occupants, potentially including information such as:

- how various systems in your vehicle were operating;
- whether or not the driver and passenger seatbelts were buckled;
- how far (if at all) the driver was depressing the accelerator and/or the brake pedal;
- how fast the vehicle was traveling; and
- where the driver was positioning the steering wheel.

Introduction

To access this information, special equipment must be directly connected to the recording modules. Ford Motor Company and Ford of Canada do not access event data recorder information without obtaining consent, unless pursuant to court order or where required by law enforcement, other government authorities or other third parties acting with lawful authority. Other parties may seek to access the information independently of Ford Motor Company and Ford of Canada.

Using your vehicle with a snowplow

For more information and guidelines for using your vehicle with a snowplow, refer to the *Driving* chapter.

Using your vehicle as an ambulance

Do not use this vehicle as an ambulance.

Your vehicle is not equipped with the Ford Ambulance Preparation Package.

Notice to owners of pickup trucks and utility type vehicles



Utility vehicles have a significantly higher rollover rate than other types of vehicles.

Before you drive your vehicle, please read this *Owner's Guide* carefully. Your vehicle is not a passenger car. As with other vehicles of this type, failure to operate this vehicle correctly may result in loss of vehicle control, vehicle rollover, personal injury or death.

Be sure to read *Driving off road* in the *Driving* chapter.

Introduction

Notice to owners of the 2007 F150

Note: Your vehicle is equipped with high performance tires. When first driving the vehicle after it has been parked for a period of time, you may experience a temporary ride disturbance. This is a characteristic of the tires and should be no reason for concern. The condition should correct itself within 5-15 miles (8-25 km) of driving. If the disturbance persists, have the tires serviced by an authorized dealer.

Cell phone use

The use of Mobile Communications Equipment has become increasingly important in the conduct of business and personal affairs. However, drivers must not compromise their own or others' safety when using such equipment. Mobile Communications can enhance personal safety and security when appropriately used, particularly in emergency situations. Safety must be paramount when using mobile communications equipment to avoid negating these benefits.

Mobile Communication Equipment includes, but is not limited to cellular phones, pagers, portable email devices, in-vehicle communications systems, telematics devices and portable two-way radios.



A driver's first responsibility is the safe operation of the vehicle. The most important thing you can do to prevent a crash is to avoid distractions and pay attention to the road. Wait until it is safe to operate Mobile Communications Equipment.



Middle East/North Africa vehicle specific information

For your particular global region, your vehicle may be equipped with features and options that are different from the ones that are described in this *Owner's Guide*; therefore, a supplement has been supplied that complements this book. By referring to the pages in the provided supplement, you can properly identify those features, recommendations and specifications that are unique to your vehicle. **Refer to this Owner's Guide for all other required information and warnings.**

Introduction





These are some of the symbols you may see on your vehicle.

Vehicle Symbol Glossary

Safety Alert		See Owner's Guide	
Fasten Safety Belt		Airbag - Front	
Airbag - Side		Child Seat	
Child Seat Installation Warning		Child Seat Lower Anchor	
Child Seat Tether Anchor		Brake System	
Anti-Lock Brake System		Brake Fluid - Non-Petroleum Based	
Powertrain Malfunction		Speed Control	
Master Lighting Switch		Hazard Warning Flasher	
Fog Lamps-Front		Fuse Compartment	
Fuel Pump Reset		Windshield Wash/Wipe	
Windshield Defrost/Demist		Rear Window Defrost/Demist	

Introduction

Vehicle Symbol Glossary

Power Windows Front/Rear		Power Window Lockout	
Child Safety Door Lock/Unlock		Interior Luggage Compartment Release Symbol	
Panic Alarm		Engine Oil	
Engine Coolant		Engine Coolant Temperature	
Do Not Open When Hot		Battery	
Avoid Smoking, Flames, or Sparks		Battery Acid	
Explosive Gas		Fan Warning	
Power Steering Fluid		Maintain Correct Fluid Level	
Emission System		Engine Air Filter	
Passenger Compartment Air Filter		Jack	
Check Fuel Cap		Low Tire Pressure Warning	

Instrument Cluster

WARNING LIGHTS AND CHIMES

Base instrument cluster

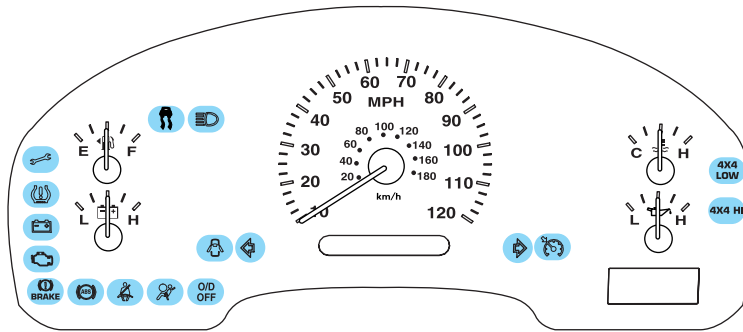

Base with Tachometer instrument cluster

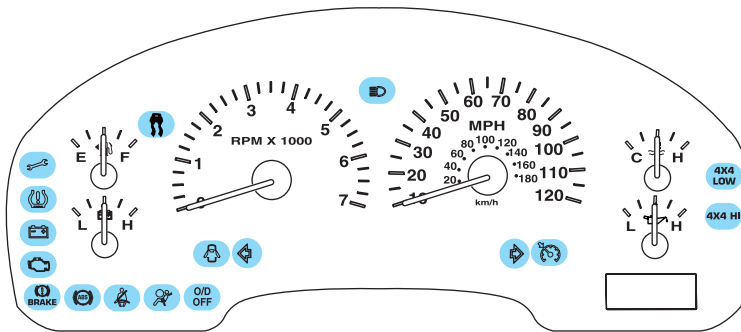

Instrument Cluster

Family Carrier instrument cluster

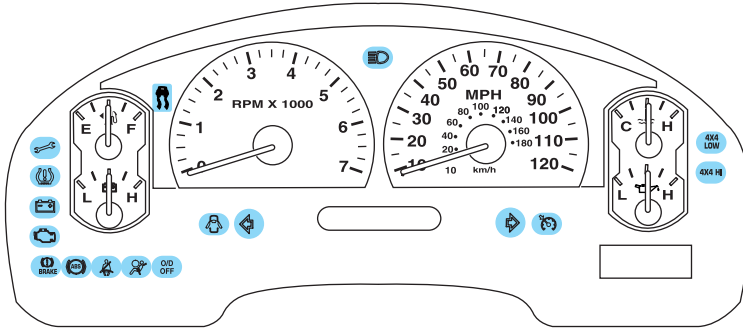

Mid instrument cluster

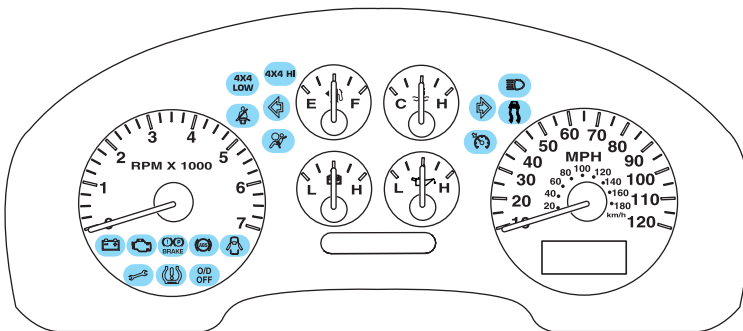

Instrument Cluster

Luxury instrument cluster

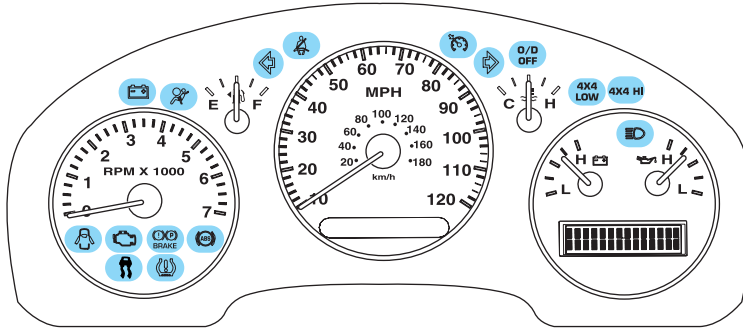

Harley-Davidson instrument cluster

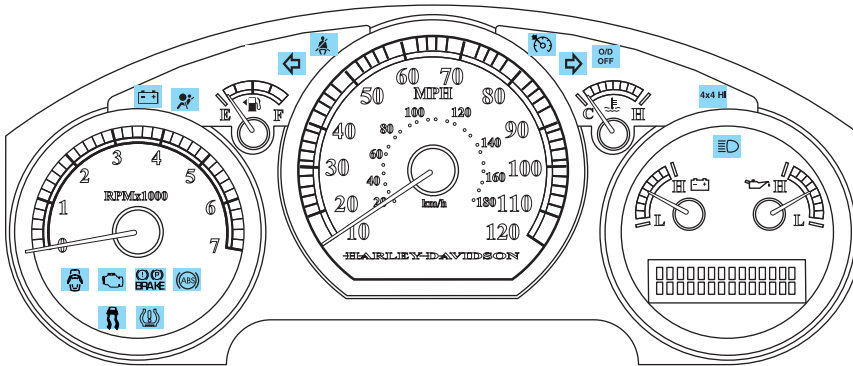

Warning lights and gauges can alert you to a vehicle condition that may become serious enough to cause expensive repairs. A warning light may illuminate when a problem exists with one of your vehicle's functions. Many lights will illuminate when you start your vehicle to make sure the bulb works. If any light remains on after starting the vehicle, refer to the respective system warning light for additional information.

Instrument Cluster

Service engine soon: The *Service engine soon* indicator light illuminates when the ignition is first turned to the ON position to check the bulb and to indicate whether the vehicle is ready for Inspection/Maintenance (I/M) testing. Normally, the "Service engine soon" light will stay on until the engine is cranked, then turn itself off if no malfunctions are present. However, if after 15 seconds the "Service engine soon" light blinks eight times, it means that the vehicle is not ready for I/M testing. See the *Readiness for Inspection/Maintenance (I/M) testing* in the *Maintenance and Specifications* chapter.



Solid illumination after the engine is started indicates the On Board Diagnostics System (OBD-II) has detected a malfunction. Refer to *On board diagnostics (OBD-II)* in the *Maintenance and Specifications* chapter. If the light is blinking, engine misfire is occurring which could damage your catalytic converter. Drive in a moderate fashion (avoid heavy acceleration and deceleration) and have your vehicle serviced immediately by your authorized dealer.



Under engine misfire conditions, excessive exhaust temperatures could damage the catalytic converter, the fuel system, interior floor coverings or other vehicle components, possibly causing a fire.

Electronic throttle control (if equipped): Illuminates when the engine has defaulted to a 'limp-home' operation. Report the fault to a dealer at the earliest opportunity.



On vehicles equipped with a message center, "ENGINE FAILSAFE MODE" will be displayed, refer to *Message Center* in the *Driver Controls* chapter.

Instrument Cluster

Brake system warning light: To confirm the brake system warning light is functional, it will momentarily illuminate when the ignition is turned to the ON position when the engine is not running, or in a position between ON and START, or by applying the parking brake when the ignition is turned to the ON position.

Base, Base with Tachometer and Family Carrier instrument cluster



Mid, Luxury and Harley-Davidson instrument cluster



If the brake system warning light does not illuminate at this time, seek service immediately from your authorized dealer. Illumination after releasing the parking brake indicates low brake fluid level and the brake system should be inspected immediately by your authorized dealer.



Driving a vehicle with the brake system warning light on is dangerous. A significant decrease in braking performance may occur. It will take you longer to stop the vehicle. Have the vehicle checked by your authorized dealer.

Anti-lock brake system: If the ABS light stays illuminated or continues to flash, a malfunction has been detected, have the system serviced immediately by your authorized dealer. Normal braking is still functional unless the brake warning light also is illuminated.



Airbag readiness: If this light fails to illuminate when ignition is turned to ON, continues to flash or remains on, have the system serviced immediately by your authorized dealer. A chime will also sound when a malfunction in the supplemental restraint system has been detected.



Instrument Cluster

Safety belt: Reminds you to fasten your safety belt. A BeltMinder® chime will also sound to remind you to fasten your safety belt. Refer to the *Seating and safety restraints* chapter to activate/deactivate the BeltMinder® chime feature.



Charging system: Illuminates when the battery is not charging properly.



Door ajar: Illuminates when the ignition is in the ON position and any door is open.



Low tire pressure warning (if equipped): Illuminates when your tire pressure is low. If the light remains ON at start up or while driving, the tire pressure should be checked. Refer to *Inflating Your Tires* in the *Tires, Wheels and Loading* chapter. When the ignition is first turned to ON, the light will illuminate for 3 seconds to ensure the bulb is working. If the light does not turn ON, have the system inspected by your authorized dealer. For more information on this system, refer to *Understanding Your Tire Pressure Monitoring System* in the *Tires, Wheels and Loading* chapter.

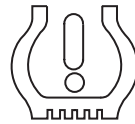

Overdrive off (if equipped): Illuminates when the overdrive function of the transmission has been turned off, refer to the *Driving* chapter. If the light does not illuminate, have the transmission serviced soon, or damage may occur.



Traction Control™ (if equipped): Illuminates when the Traction Control™ is active. If the light remains on, have the system serviced immediately, refer to the *Driving* chapter for more information.



Instrument Cluster

Four wheel drive low (if equipped): Illuminates when four-wheel drive low is engaged.

4x4
LOW

Four wheel drive high (if equipped): Illuminates when four-wheel drive high is engaged.

4x4 HI

Speed control: Illuminates when the speed control is activated. Turns off when the speed control system is deactivated.

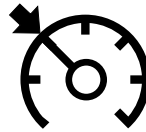

Turn signal: Illuminates when the left or right turn signal or the hazard lights are turned on. If the indicators stay on or flash faster, check for a burned out bulb.



High beams: Illuminates when the high beam headlamps are turned on.



MINI MESSAGE CENTER WARNING DISPLAYS (IF EQUIPPED)

Door ajar: Displays when the ignition is in the ON position and any door is open.

DOOR
AJAR

Low fuel: Displays when the fuel level in the fuel tank is at or near empty (refer to *Fuel gauge* in this chapter).

LOW
FUEL

Check fuel cap: Displays when the fuel cap may not be properly installed. Continued driving with this display on may cause the Service engine soon warning light to come on. Refer to *Fuel filler cap* in the *Maintenance and Specifications* chapter.

CHECK
FUELCAP

Instrument Cluster

Check gauge: Displays when any of the following conditions has occurred:

- The engine coolant temperature is high.
- The engine oil pressure is low.
- The fuel gauge is at or near empty.

CHECK
GAUGES

Trans Fault: Displays when a transmission problem has been detected and shifting may be restricted. If the light remains on, have the system serviced immediately by your authorized dealer.

TRANS
FAULT

Key-in-ignition warning chime: Sounds when the key is left in the ignition in the OFF/LOCK or ACCESSORY position and the driver's door is opened.

Headlamps on warning chime: Sounds when the headlamps or parking lamps are on, the ignition is off (the key is not in the ignition) and the driver's door is opened.

GAUGES

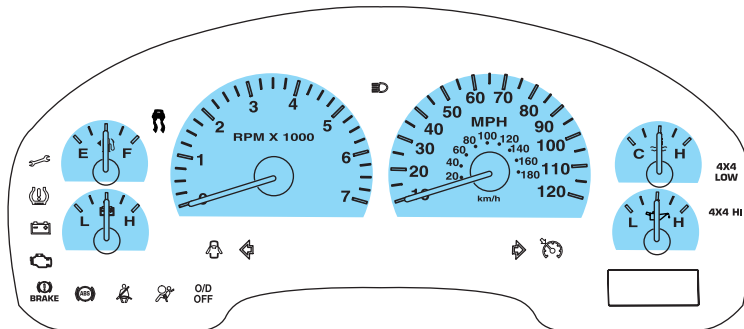

Instrument Cluster

Speedometer: Indicates the current vehicle speed.

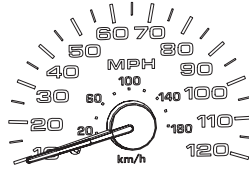

Engine coolant temperature gauge: Indicates engine coolant temperature. At normal operating temperature, the needle will be in the normal range (between “H” and “C”). If it enters the red section, the engine is overheating. Stop the vehicle as soon as safely possible, switch off the engine and let the engine cool.

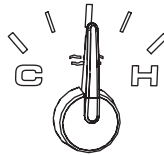

Never remove the coolant reservoir cap while the engine is running or hot.

Odometer: Registers the total miles (kilometers) of the vehicle.

- With Mini Message Center



- With Full Message Center

Refer to Message Center in the Drivers Controls chapter on how to switch the display from Metric to English.

NW 888888 mi

Trip odometer: Registers the miles (kilometers) of individual journeys.

- With Mini Message Center

Press and release the button on top of the cluster to toggle between odometer and trip odometer display. Press and hold the button to reset Trip Odometer.



Instrument Cluster

- With Full Message Center

Press and release the message center INFO button until TRIP mode appears in the display. Press the RESET button to reset.

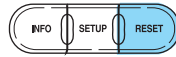

Tachometer (if equipped):

Indicates the engine speed in revolutions per minute. Driving with your tachometer pointer continuously at the top of the scale may damage the engine.

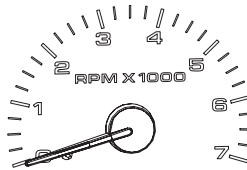

Battery voltage gauge: Indicates the battery voltage when the ignition is in the ON position. If the pointer moves and stays outside the normal operating range, have the vehicle's electrical system checked by your authorized dealer as soon as possible.

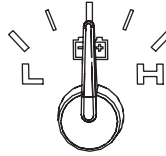

Engine oil pressure gauge:

Indicates engine oil pressure. The needle should stay in the normal operating range (between "L" and "H"). If the needle falls below the normal range, stop the vehicle, turn off the engine and check the engine oil level. Add oil if needed. If the oil level is correct, have your vehicle checked by your authorized dealer.

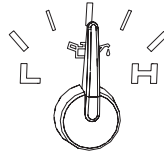

Fuel gauge: Indicates approximately how much fuel is left in the fuel tank (when the ignition is in the ON position). The fuel gauge may vary slightly when the vehicle is in motion or on a grade.

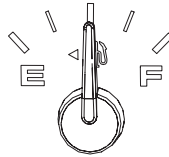

The arrow next to the fuel pump icon indicates which side of the vehicle the fuel filler door is located.

For more information, refer to *Filling the tank* in the *Maintenance and Specifications* chapter.

Entertainment Systems

AUDIO SYSTEMS

Quick start — How to get going

Listening to the radio

1. If the audio system is off, press VOL-PUSH to turn the radio on. Turn VOL-PUSH to adjust the volume.

VOL - PUSH



Note: The system may take a few moments to turn on.

2. Press AM/FM repeatedly to choose between AM/FM1/FM2 frequency bands.



3. Press ▲ / ▼ to manually go up/down the frequency band.

Press ◀ SEEK ▶ to search down/up the chosen frequency band for the next strongest station.



To disengage SEEK mode, press ▲ / ▼ .

4. Once you are tuned to the desired station, press and hold a memory preset (1–6) to save the station. PRESET SAVED will appear on the display and the sound will return signifying the station has been saved. You can save up to six stations in each frequency band — six in AM, six in FM1 and six in FM2.



To access your saved stations, press the corresponding memory preset. The memory preset # and the station frequency will appear on the display.

Listening to satellite radio (if equipped)

1. If the audio system is turned off, press VOL-PUSH to turn the radio on. Turn VOL-PUSH to adjust the volume.

VOL - PUSH



Note: The system may take a few moments to turn on.

Entertainment Systems

2. Press AUX repeatedly to cycle through auxiliary audio sources. Select SAT1, SAT2 or SAT3 to listen to satellite radio.



3. Press ◀ SEEK, SEEK ▶ to access the previous or next satellite channel.

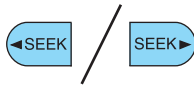

You may also seek by music category. For further information, refer to *CATEGORY* listing under the MENU control on your specific audio system.

4. Once you are tuned to the desired channel, press and hold a memory preset (1–6) to save the channel. PRESET SAVED will appear on the display and the sound will return signifying the station has been saved. You can save up to six channels in each — six in SAT1, six in SAT2, and six in SAT3.



To access your saved channels, press the corresponding memory preset. The memory preset # and the channel name will appear on the display.

Listening to a CD/MP3 (if equipped)

1. If the audio system is turned off, press VOL-PUSH to turn the radio on. Turn VOL-PUSH to adjust the volume.

VOL - PUSH



Note: The system may take a few moments to turn on.

2. Press CD to enter CD mode. If a disc is already loaded into the system, CD play will begin where it ended last.



For a single CD system, if a disc is not already loaded, insert only one, label side up into the CD slot. LOADING CD and READING DISC will appear in the display. The first track on the disc will begin playing.



Entertainment Systems

For an in-dash six CD system, if a disc is not already loaded, press LOAD. Select a slot number using memory presets 1–6. When the display reads LOAD CD#, load the desired disc, label side up. If you do not choose a slot within 5 seconds, the system will choose for you. Once loaded, the first track will begin to play.



To auto load up to 6 discs, press and hold LOAD until the display reads AUToload#. Load the desired disc, label side up. The system will prompt you to load discs for the remaining available slots. Insert the discs, one at a time, label side up, when prompted. Once loaded, the disc in preset #1 will begin to play.

Note: An MP3 disc with folders will show F001 (folder #) T001 (track #) in the display. An MP3 disc without folders will show T001 (track#) in the display. Refer to *MP3 folder structure* later in this chapter for further information.

3. In CD/MP3 mode, you can access the following features:

Press ◀ SEEK, SEEK ▶ to access the previous/next tracks.

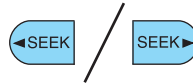

Press and hold REW to manually reverse in a CD/MP3 track.



Press and hold FF to manually advance in a CD/MP3 track.



Press ◀ FOLDER to access the previous folder on MP3 discs, if available.



Press FOLDER ▶ to access the next folder on MP3 discs, if available.



Entertainment Systems

Press SHUFFLE to engage shuffle mode. SHUFFLE ON will appear in the display. If you wish to engage shuffle mode right away, press SEEK to begin random play. Otherwise, random play will begin when the current track is finished playing. CD SHUF will appear in the display. To disengage, press SHUFFLE again. SHUFFLE OFF will appear in the display.



Note: In track mode, all tracks on the *current* disc will shuffle in random order. In MP3 folder mode, the system will randomly play all tracks within the *current* folder.

Press ►/|| (play/pause) when a CD/MP3 is playing to pause the disc. CD PAUSE will appear in the display. Press again to resume play.



4. **For a single cd system,** press ▲ to eject the current disc. The display will read CD EJECT.



For an in-dash six CD system, press ▲. Select the correct slot number using memory presets 1–6. When ready, the system will eject the disc and the display will read REMOVE CD. If the disc is not removed in 15 seconds, the system will reload the disc.

To auto eject up to 6 discs, press and hold ▲ until the system begins ejecting all loaded discs. If the discs are not removed, the system will reload the discs.

Entertainment Systems

AM/FM stereo system (if equipped)

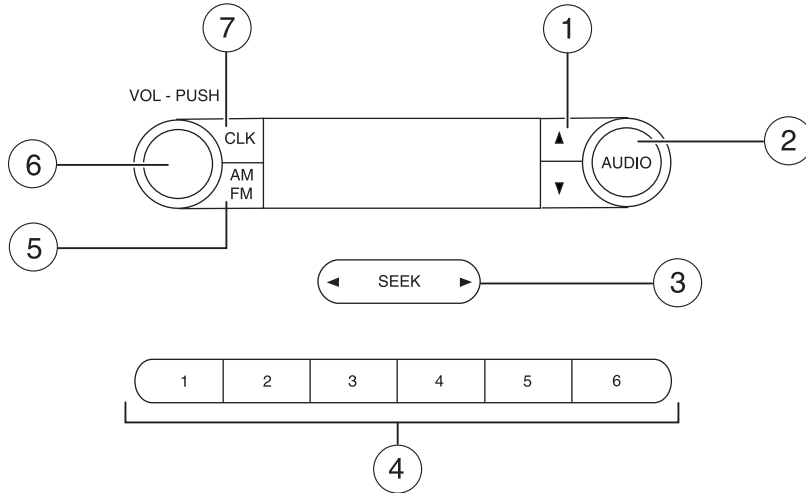

Accessory delay: Your vehicle is equipped with accessory delay which allows you to operate the window switches and the audio for up to ten minutes after the ignition has been turned off or until either front door is opened.

1. **▲ / ▼** : Press **▲ / ▼** to manually go up or down the radio frequency. Press and hold for a fast advance through radio frequencies. Also use in AUDIO mode to gain access to various settings.



2. **AUDIO**: Press AUDIO repeatedly to gain access to the following settings:



BAL (Balance): Press AUDIO to reach the balance setting.

Use **▲ / ▼ / ◀ SEEK ▶** to adjust the audio between the left (L) and right (R) speakers.

Entertainment Systems

FAD (Fade): Press AUDIO to reach the fade feature. Use ▲ / ▼ / ◀ SEEK ▶ to adjust the audio between the front (F) and back (B) speakers.

TREB (Treble): Press to adjust the treble setting. Use ▲ / ▼ / ◀ SEEK ▶ to adjust.

BASS (Bass): Press to adjust the bass setting. Use ▲ / ▼ / ◀ SEEK ▶ to adjust.

3. **SEEK:** Press ◀ SEEK ▶ to access the previous/next strong station.



4. **Memory presets:** To set a station: Select frequency band AM/FM1/FM2; tune to a station, press and hold a preset button until sound returns. You can save up to 18 stations, six in AM, six in FM1 and FM2.



5. **AM/FM:** Press AM/FM to select AM/FM1/FM2 frequency band.



6. **ON/OFF/Volume:** Press VOL-PUSH to turn ON/OFF. Turn VOL-PUSH to increase/decrease volume.

VOL - PUSH



Note: If the volume is set above a certain level and the ignition is turned off, the volume will come back on at a “nominal” listening level when the ignition switch is turned back on.

7. **CLK (Clock):** Press CLK to toggle between displaying the radio frequency and the clock setting.



Setting the clock: Press and hold CLK until the hours begin to flash. Press ▲ / ▼ / ◀ SEEK ▶ to manually increase/decrease the hours. Press CLK again to set the minutes using ▲ / ▼ / ◀ SEEK ▶ to manually increase/decrease the minutes. Allow 10 seconds to pass to confirm that the time has been set.

Entertainment Systems

AM/FM stereo single CD/satellite compatible sound system (if equipped)

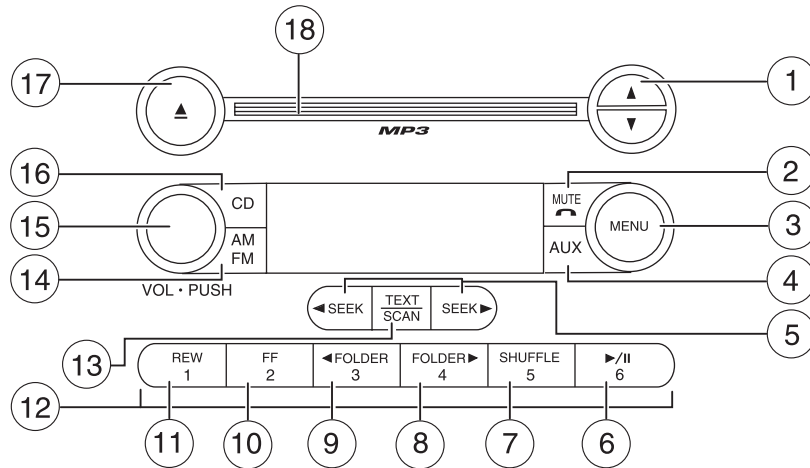

Accessory delay: Your vehicle is equipped with accessory delay which allows you to operate the window switches and the audio for up to ten minutes after the ignition has been turned off or until either front door is opened.

1. ▲ / ▼ : Press ▲ / ▼ to manually go up or down the radio frequency. Press and hold for a fast advance through radio frequencies.



In satellite radio mode (if equipped), press ▲ / ▼ to tune to the next/previous channel.

Satellite radio is available only with a valid SIRIUS radio subscription. Check with your authorized dealer for availability.

2. MUTE/⏸ : Press to mute the playing media. Press again to return to the playing media.



Entertainment Systems

3. **MENU:** Press MENU repeatedly to access to the following settings:



CATEGORY (satellite radio if equipped): Press MENU until the currently active category appears in the display (CATEGORY MODE). In CATEGORY MODE, press ▲ / ▼ to scroll through the list of available SIRIUS channel Categories (Pop, Rock, News, etc.) Press ◀ SEEK, SEEK ▶ or SCAN to select the category. After a category is selected, press SEEK to search for that specific category of channels only (i.e. ROCK). To select a different category, press MENU until the category appears in the display. Press ▲ / ▼ to select a different category. You may also select CATEGORY ALL to seek all available SIRIUS categories and channels.

Satellite radio is available only with a valid SIRIUS radio subscription. Check with your authorized dealer for availability.

Setting the clock: Press MENU until SET HOUR or SET MINUTES is displayed. Use ▲ / ▼ / ◀ SEEK, SEEK ▶ to adjust the hours/minutes.

AUTOSET: Press MENU until the display reads AUTOSET. Autoset allows you to set the strongest local radio stations without losing your original manually set preset stations for AM/FM1/FM2. Use ▲ / ▼ / ◀ SEEK, SEEK ▶ to turn on/off.

When the six strongest stations are filled, the station stored in preset 1 will begin playing. If there are less than six strong stations, the system will store the last one in the remaining presets.

BASS: Press MENU to reach the bass setting. Use ▲ / ▼ / ◀ SEEK, SEEK ▶ to adjust.

TREB (Treble): Press MENU to reach the treble setting. Use ▲ / ▼ / ◀ SEEK, SEEK ▶ to adjust.

BAL (Balance): Press MENU to reach the balance setting. Use ▲ / ▼ / ◀ SEEK, SEEK ▶ to adjust the audio between the left (L) and right (R) speakers.

Entertainment Systems

FADE: Press MENU to reach the fade setting. Use ▲ / ▼ /

◀ SEEK, SEEK ▶ to adjust the audio between the back (B) and front (F) speakers.

SPEEDVOL (Speed sensitive volume, if equipped): Press MENU to reach the SPEEDVOL setting. Radio volume automatically gets louder with increasing vehicle speed to compensate for road and wind noise.

Use ▲ / ▼ / ◀ SEEK, SEEK ▶ to adjust.

The default setting is *off*; increasing your vehicle speed will not change the volume level.

Adjust 1–7: Increasing this setting from 1 (lowest setting) to 7 (highest setting) allows the radio volume to automatically change slightly with vehicle speed to compensate for road and wind noise.

Recommended level is 1–3; SPEED OFF turns the feature off and level 7 is the maximum setting.

Track/Folder mode: Available only on MP3 discs in CD mode. In Track mode, pressing ◀ SEEK, SEEK ▶ will scroll through all tracks on the disc

In Folder mode, pressing ◀ SEEK, SEEK ▶ will scroll only through tracks within the selected folder.

Press ◀ FOLDER, FOLDER ▶ to access the previous/next folder (if available).

COMPRESS (Compression): Available only in CD/MP3 mode. Press MENU until COMPRESS ON/OFF appears in the display. Use ▲ / ▼ / ◀ SEEK, SEEK ▶ to toggle ON/OFF. When COMPRESS is ON, the system will bring the soft and loud CD passages together for a more consistent listening level.

4. **AUX:** Press repeatedly to cycle through FES/DVD (if equipped), LINE IN (auxiliary audio mode, if equipped) and SAT1, SAT2 and SAT3 modes (satellite radio, if equipped).



For location and further information on auxiliary audio mode, refer to *Auxiliary input jack* later in this chapter.

Satellite radio is available only with a valid SIRIUS radio subscription. Check with your authorized dealer for availability.

Entertainment Systems

5. **SEEK:** In radio mode, press ◀ / ▶ to access the previous/next strong station.

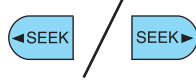

In CD/MP3 mode, press ◀ / ▶ to access the previous/next CD/MP3 track.

In satellite radio mode (if equipped), press ◀ SEEK, SEEK ▶ to seek to the previous/next channel. If a specific category is selected, (Jazz, Rock, News, etc.), press ◀ SEEK, SEEK ▶ to seek to the previous/next channel in the selected category. Press and hold ◀ SEEK, SEEK ▶ to fast seek through the previous /next channels.

In TEXT MODE, press ◀ SEEK, SEEK ▶ to view the previous/additional display text.

In CATEGORY MODE, press ◀ SEEK, SEEK ▶ to select a category.

Satellite radio is available only with a valid SIRIUS radio subscription. Check with your authorized dealer for availability.

6. ▶ / || (Play/Pause): This



control is operational in CD/MP3 mode. When a CD/MP3 is playing, press to pause or play the current CD/MP3. The CD/MP3 status will display in the radio display.

If your vehicle is equipped with a Family Entertainment System (FES) please refer to the *DVD supplement* for further information.

7. **SHUFFLE:** In CD/MP3 mode, press SHUFFLE to engage shuffle mode. SHUFFLE ON will appear in



the display. If you wish to engage shuffle mode right away, press SEEK to begin random play. Otherwise, random play will begin when the current track is finished playing. CD SHUF will appear in the display. To disengage, press SHUFFLE again. SHUFFLE OFF will appear in the display.

Note: In CD/MP3 mode, press SHUFFLE to play the tracks in random order. In MP3 folder mode, the system will randomly play all tracks within the current folder.

8. **FOLDER▶** : In folder mode, press FOLDER▶ to access next folder on MP3 discs, if available.



Entertainment Systems

9. **FOLDER:** In folder mode, press **FOLDER** to access the previous folder on MP3 discs, if available.



10. **FF (Fast forward):** Press FF to manually advance in a CD/MP3 track.



11. **REW (Rewind):** Press REW to manually reverse in a CD/MP3 track.



12. **Memory presets:** To set a station: Select frequency band AM/FM1/FM2; tune to a station, press and hold a preset control until sound returns. You may store up to six stations in each frequency band for a total of 18.



In satellite radio mode (if equipped), there are 18 available presets, six each for SAT1, SAT2 and SAT3. To save satellite channels in your memory presets, tune to the desired channel then press and hold a preset control until sound returns.

Satellite radio is available only with a valid SIRIUS radio subscription. Check with your authorized dealer for availability.

13. **TEXT/SCAN: In radio and CD/MP3 mode,** press and hold for a brief sampling of radio stations or CD tracks. Press again to stop.



In CD/MP3 mode, press and release to display track title, artist name, and disc title.

In satellite radio mode (if equipped), press and release to enter TEXT MODE and display the current song title. While in TEXT MODE, press again to scroll through the current song title, artist, channel category and the SIRIUS long channel name.

In TEXT MODE sometimes the display requires additional text to be displayed. When the “>” indicator is active, press **SEEK** **▶** to view the additional display text. When the “<” indicator is active, press **SEEK** **◀** to view the previous display text.

In satellite radio mode (if equipped), press and hold to hear a brief sampling of the next channels. Press again to stop. In CATEGORY MODE, press **SCAN** to hear a brief sampling of the channels in the selected category. Press again to stop.

Entertainment Systems

Satellite radio is available only with a valid SIRIUS radio subscription. Check with your authorized dealer for availability.

14. **AM/FM:** Press AM/FM to select AM/FM1/FM2 frequency band.



15. **ON/OFF/Volume:** Press VOL-PUSH to turn ON/OFF. Turn VOL-PUSH to increase/decrease volume.



Note: If the volume is set above a certain level and the ignition is turned off, the volume will come back on at a “nominal” listening level when the ignition switch is turned back on.

16. **CD:** Press to enter CD/MP3 mode. If a CD/MP3 is already loaded into the system, CD/MP3 play will begin where it ended last.



17. **▲ (CD eject):** Press to eject a CD/MP3.



18. **CD slot:** Insert a CD/MP3 label side up in the CD slot.



Entertainment Systems

Premium/Audiophile in-dash six CD/MP3/satellite compatible sound system (if equipped)

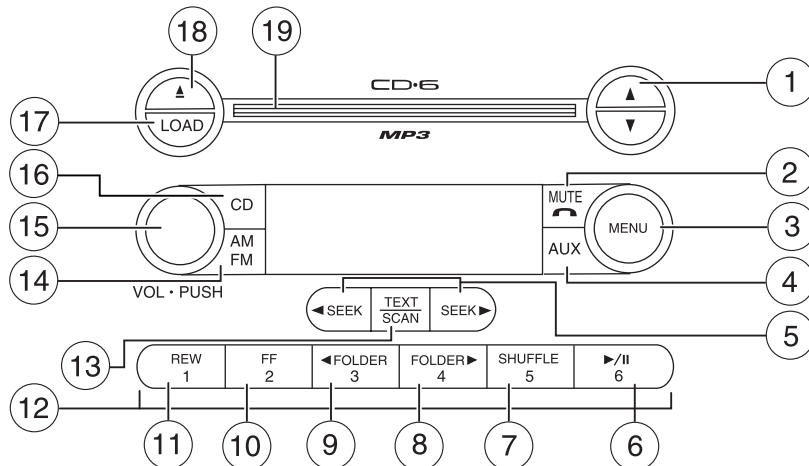

Accessory delay: Your vehicle is equipped with accessory delay which allows you to operate the window switches and audio for up to ten minutes after the ignition has turned off or until either front door has opened.

1. ▲ / ▼ **(Tune/Disc selector):**

In radio mode, press to manually go up (▲) or down (▼) the radio frequency. Press and hold for a fast advance through radio frequencies.

In menu mode, use to select various settings.

In CD/MP3 mode, press to select the desired disc.



Satellite radio is available only with a valid SIRIUS radio subscription. Check with your authorized dealer for availability.

2. **MUTE/** : Press to mute the playing media. Press again to return to the playing media.



Entertainment Systems

3. **MENU:** Press repeatedly to access to the following settings:



CATEGORY (satellite radio if equipped): Press MENU until the currently active category appears in the display (CATEGORY MODE). In CATEGORY MODE, press ▲ / ▼ to scroll through the list of available SIRIUS channel Categories (Pop, Rock, News, etc.) Press ◀ SEEK ▶ or SCAN to select the category. After a category is selected, press SEEK to search for that specific category of channels only (i.e. ROCK). To select a different category, press MENU until the category appears in the display. Press ▲ / ▼ to select a different category. You may also select CATEGORY ALL to seek all available SIRIUS categories and channels. *Satellite radio is available only with a valid SIRIUS radio subscription. Check with your authorized dealer for availability.*

Setting the clock: Press until SELECT HOUR or SELECT MINS is displayed. Press ▲ / ▼ / ◀ SEEK ▶ to adjust the hours/minutes.

AUTOSET: Press MENU until the display reads AUTOSET. Autoset allows you to set the strongest local radio stations without losing your original manually set preset stations for AM/FM1/FM2. Use ▲ / ▼ / ◀ SEEK, SEEK ▶ to turn on/off.

When the six strongest stations are filled, the station stored in preset 1 will begin playing. If there are less than six strong stations, the system will store the last one in the remaining presets.

RBDS: Available only in FM mode. This feature allows you to search RBDS-equipped stations for a certain category of music format: CLASSIC, COUNTRY, INFORM, JAZZ/RB, ROCK, etc.

To activate, press MENU repeatedly until RBDS (ON/OFF) appears in the display. Use ▲ / ▼ / ◀ SEEK ▶ to toggle RBDS ON/OFF. When RBDS is OFF, you will not be able to search for RBDS equipped stations or view the station name or type.

To search for specific RBDS music categories: When the desired category appears in the display, press ▲ / ▼ to find the desired type, then press and release ◀ SEEK, SEEK ▶ or press and hold SCAN to begin the search.

To view the station name or type: When the desired category appears in the display, press TEXT/SCAN to toggle between displaying the station type (COUNTRY, ROCK, etc.) or the station name (WYCD, WXYZ, etc.).

Entertainment Systems

BASS: Press MENU to reach the bass setting. Use ▲ / ▼ / ◀ SEEK, SEEK ▶ to adjust.

TREB (Treble): Press MENU to reach the treble setting. Use ▲ / ▼ / ◀ SEEK, SEEK ▶ to adjust.

BAL (Balance): Press MENU to reach the balance setting. Use ▲ / ▼ / ◀ SEEK, SEEK ▶ to adjust the audio between the left (L) and right (R) speakers.

FADE: Press MENU to reach the fade setting. Use ▲ / ▼ / ◀ SEEK, SEEK ▶ to adjust the audio between the back (B) and front (F) speakers.

ALL SEATS (Occupancy mode) (Available on Audiophile radios only): Press MENU repeatedly to access. Press ▲ / ▼ / ◀ SEEK ▶ to optimize sound for ALL SEATS, DRIVERS SEAT or REAR SEATS.

SPEEDVOL (Speed sensitive volume, if equipped): Press MENU to reach the SPEEDVOL setting. Radio volume automatically gets louder with increasing vehicle speed to compensate for road and wind noise. Use ▲ / ▼ / ◀ SEEK, SEEK ▶ to adjust.

The default setting is *off*; increasing your vehicle speed will not change the volume level.

Adjust 1–7: Increasing this setting from 1 (lowest setting) to 7 (highest setting) allows the radio volume to automatically change slightly with vehicle speed to compensate for road and wind noise.

Recommended level is 1–3; SPEED OFF turns the feature off and level 7 is the maximum setting.

Track/Folder Mode: Available only on MP3 discs in CD mode. In Track Mode, pressing ◀ SEEK ▶ will scroll through all tracks on the disc.

In Folder mode, pressing ◀ SEEK ▶ will scroll only through tracks within the selected folder.

Press ◀ FOLDER, FOLDER ▶ to access the previous/next folder (if available).

Entertainment Systems

COMPRESS (Compression): Available only in CD/MP3 mode. Press MENU until COMPRESS ON/OFF appears in the display. Use ▲ / ▼ / ◀ SEEK, SEEK ▶ to toggle ON/OFF. When COMPRESS is ON, the system will bring soft and loud CD passages together for a more consistent listening level.

4. **AUX:** Press repeatedly to cycle through FES/DVD (if equipped), LINE IN (Auxiliary audio mode, if equipped), SAT1, SAT2 and SAT3 modes (Satellite Radio, if equipped). For location and further information on the auxiliary audio mode, refer to *Auxiliary input jack* later in this chapter.



Satellite radio is available only with a valid SIRIUS radio subscription. Check with your authorized dealer for availability.

5. **SEEK: In radio mode,** press ◀ / ▶ to access the previous/next strong station.

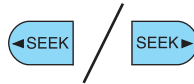

In CD mode, press ◀ / ▶ to access the previous/next CD track.

In satellite radio mode (if equipped), press ◀ SEEK, SEEK ▶ to seek to the previous/next channel. If a specific category is selected, (Jazz, Rock, News, etc.), press ◀ SEEK, SEEK ▶ to seek to the previous/next channel in the selected category. Press and hold ◀ SEEK, SEEK ▶ to fast seek through the previous /next channels.

In TEXT MODE, press ◀ SEEK, SEEK ▶ to view the previous/additional display text.

In CATEGORY MODE, press ◀ SEEK, SEEK ▶ to select a category.

Satellite radio is available only with a valid SIRIUS radio subscription. Check with your authorized dealer for availability.

6. **▶ || (Play/Pause):** This control



is operational in CD mode. When a CD is playing, press to pause or play the current CD. The CD status will display in the radio display.

If your vehicle is equipped with a Family Entertainment System (FES) please refer to the *DVD supplement* for further information.

Entertainment Systems

7. **SHUFFLE:** In CD/MP3 mode, press SHUFFLE to engage shuffle mode. SHUFFLE ON will appear in the display. If you wish to engage shuffle mode right away, press SEEK to begin random play. Otherwise, random play will begin when the current track is finished playing. CD SHUF will appear in the display. To disengage, press SHUFFLE again. SHUFFLE OFF will appear in the display.



Note: In track mode, all tracks on the *current* disc will shuffle in random order. In MP3 folder mode, the system will randomly play all tracks within the current folder.

8. **FOLDER▶**: In folder mode, press FOLDER▶ to access next folder on MP3 discs, if available.



9. **<FOLDER**: In folder mode, press <FOLDER to access the previous folder on MP3 discs, if folders are available.



10. **FF (Fast forward):** Press FF to manually advance in a CD/MP3 track.



11. **REW (Rewind):** Press REW to manually reverse in a CD/MP3 track.



12. **Memory presets:** To set a station: Select frequency band AM/FM1/FM2; tune to a station, press and hold a preset control until sound returns. You may store up to six stations in each frequency band for a total of 18.



In satellite radio mode (if equipped), there are 18 available presets, six each for SAT1, SAT2 and SAT3. To save satellite channels in your memory presets, tune to the desired channel then press and hold a preset control until sound returns.

Satellite radio is available only with a valid SIRIUS radio subscription. Check with your authorized dealer for availability.

13. **TEXT/SCAN:** In radio and CD/MP3 mode, press and hold to hear a brief sampling of radio stations or CD tracks.



Entertainment Systems

In CD/MP3 mode, press and release to display track title, artist name, and disc title and file name (if available).

In satellite radio mode (if equipped), press and release to enter TEXT MODE and display the current song title. While in TEXT MODE, press again to scroll through the current song title, artist, channel category and the SIRIUS long channel name.

In TEXT MODE, sometimes the display requires additional text to be displayed. When the “>” indicator is active, press SEEK▶ to view the additional display text. When the “>” indicator is active, press ◀ SEEK to view the previous display text.

In satellite radio mode (if equipped), press and hold to hear a brief sampling of the next channels. Press again to stop.

In CATEGORY MODE, press SCAN to hear a brief sampling of channels in the selected category. Press again to stop. *Satellite radio is available only with a valid SIRIUS subscription. Check with your authorized dealer for availability.*

14. **AM/FM:** Press to select AM/FM1/FM2 frequency band.



15. **ON/OFF/Volume:** Press to turn ON/OFF. Turn to increase/decrease volume.



Note: If the volume is set above a certain level and the ignition is turned off, the volume will come back on at a “nominal” listening level when the ignition switch is turned back on.

16. **CD:** Press to enter CD/MP3 mode. If a CD/MP3 is already loaded into the system, CD/MP3 play will begin where it ended last.



17. **LOAD:** To load a disc into the system, press LOAD. Select a slot number using memory presets 1–6. When the display reads LOAD CD#, load the desired disc, label side up. If you do not choose a slot within 5 seconds, the system will choose for you. Once loaded, the first track will begin to play.



Entertainment Systems

To auto load up to 6 discs, press and hold LOAD until the display reads AUToload#. Load the desired disc, label side up. The system will prompt you to load discs for the remaining available slots. Insert the discs, one at a time, label side up, when prompted. Once loaded, the disc in preset #1 will begin to play.

Note: An MP3 disc with folders will show F001 (folder #) T001 (track #) in the display. An MP3 disc without folders will show T001 (track#) in the display. Refer to *MP3 folder structure* later in this chapter for further information.

18. **▲ (CD eject):** To eject a disc from the system, press ▲. Select the correct slot number using memory presets 1–6. When ready, the system will eject the disc and the display will read REMOVE CD. If the disc is not removed in 15 seconds, the system will reload the disc.



To auto eject up to 6 CDs, press and hold ▲ until the system begins ejecting all loaded discs. If the discs are not removed, the system will reload the discs.

19. **CD slot:** Insert a CD/MP3 label side up.



Entertainment Systems

Auxiliary input jack (if equipped)

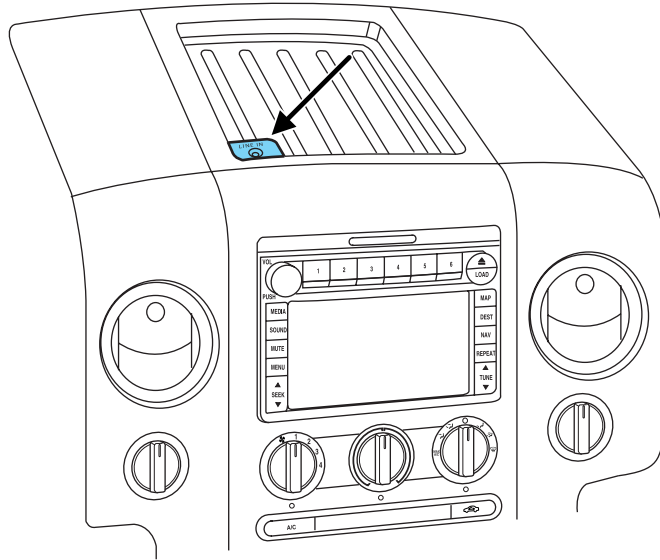

Your vehicle may be equipped with an Auxiliary Input Jack (AIJ), located in the instrument panel tray. The Auxiliary Input Jack provides a way to connect your portable music player to the in-vehicle audio system. This allows the audio from a portable music player to be played through the vehicle speakers with high fidelity. To achieve optimal performance, please observe the following instructions when attaching your portable music device to the audio system.

Required equipment:

1. Any portable music player designed to be used with headphones
2. An audio extension cable with stereo male 1/8 in. (3.5 mm) connectors at each end

To play your portable music player using the auxiliary input jack:

1. Begin with the vehicle parked and the radio turned off.
2. Ensure that the battery in your portable music player is new or fully charged and that the device is turned off.
3. Attach one end of the audio extension cable to the headphone output of your player and the other end of the audio extension cable to the AIJ in your vehicle.

Entertainment Systems

4. Turn the radio on, using either a tuned FM station or a CD loaded into the system. Adjust the volume to a comfortable listening level.
5. Turn the portable music player on and adjust the volume to 1/2 the volume.
6. Press AUX on the vehicle radio repeatedly until LINE IN appears in the display.
You should hear audio from your portable music player although it may be low.
7. Adjust the sound on your portable music player until it reaches the level of the FM station or CD by switching back and forth between the AUX and FM or CD controls.

Troubleshooting:

1. Do not connect the audio input jack to a line level output. Line level outputs are intended for connection to a home stereo and are not compatible with the AIJ. The AIJ will only work correctly with devices that have a headphone output with a volume control.
2. Do not set the portable music player's volume level higher than is necessary to match the volume of the CD or FM radio in your audio system as this will cause distortion and will reduce sound quality. Many portable music players have different output levels, so not all players should be set at the same levels. Some players will sound best at full volume and others will need to be set at a lower volume.
3. If the music sounds distorted at lower listening levels, turn the portable music player volume down. If the problems persists, replace or recharge the batteries in the portable music player.
4. The portable music player must be controlled in the same manner when it is used with headphones as the AIJ does not provide control (play, pause, etc.) over the attached portable music player.
5. For safety reasons, connecting or adjusting the settings on your portable music player should not be attempted while the vehicle is moving. Also, the portable music player should be stored in a secure location, such as the center console or the glove box, when the vehicle is in motion. The audio extension cable must be long enough to allow the portable music player to be safely stored while the vehicle is in motion.

GENERAL AUDIO INFORMATION

Radio frequencies:

AM and FM frequencies are established by the Federal Communications Commission (FCC) and the Canadian Radio and Telecommunications Commission (CRTC). Those frequencies are:

Entertainment Systems

AM: 530, 540–1700, 1710 kHz

FM: 87.7, 87.9–107.7, 107.9 MHz

Radio reception factors:

There are three factors that can affect radio reception:

- Distance/strength: The further you travel from an FM station, the weaker the signal and the weaker the reception.
- Terrain: Hills, mountains, tall buildings, power lines, electric fences, traffic lights and thunderstorms can interfere with your reception.
- Station overload: When you pass a broadcast tower, a stronger signal may overtake a weaker one and play while the weak station frequency is displayed.

CD/CD player care

Do:

- Handle discs by their edges only. Never touch the playing surface.
- Inspect discs before playing. Clean only with an approved CD cleaner and wipe from the center out.

Don't:

- Expose discs to direct sunlight or heat sources for extended periods of time.
- Clean using a circular motion.

CD units are designed to play commercially pressed 4.75 in (12 cm) audio compact discs only. Due to technical incompatibility, certain recordable and re-recordable compact discs may not function correctly when used in Ford CD players. Dirty, warped or damaged CDs, irregular shaped CDs, CDs with a scratch protection film attached, and CDs with homemade paper (adhesive) labels should not be inserted into the CD player. The label may peel and cause the CD to become jammed. It is recommended that homemade CDs be identified with permanent felt tip marker rather than adhesive labels. Ballpoint pens may damage CDs. Please contact your authorized dealer for further information.

Audio system warranty and service

Refer to the *Warranty Guide* for audio system warranty information. If service is necessary, see your dealer or qualified technician.

Entertainment Systems

MP3 track and folder structure

Your MP3 system recognizes MP3 individual tracks and folder structure as follows:

- There are two different modes for MP3 disc playback: MP3 track mode (system default) and MP3 folder mode. For more information on track and folder mode, refer to *Sample MP3 structure* in the following section.
- MP3 track mode ignores any folder structure on the MP3 disc. The player numbers each MP3 track on the disc (noted by the .mp3 file extension) from T001 to T255.
- MP3 folder mode represents a folder structure consisting of one level of folders. The CD player numbers all MP3 tracks on the disc (noted by the .mp3 file extension) and all folders containing MP3 files, from F001 (folder) T001 (track) to F253 T255.
- Creating discs with only one level of folders will help with navigation through the disc files.

Sample MP3 structure

If you are burning your own MP3 discs, it is important to understand how the system will read the structures you create. While various files may be present, (files with extensions other than mp3), only files with the .mp3 extension will be played. Other files will be ignored by the system. This enables you to use the same MP3 disc for a variety of tasks on your work computer, home computer and your in vehicle system.

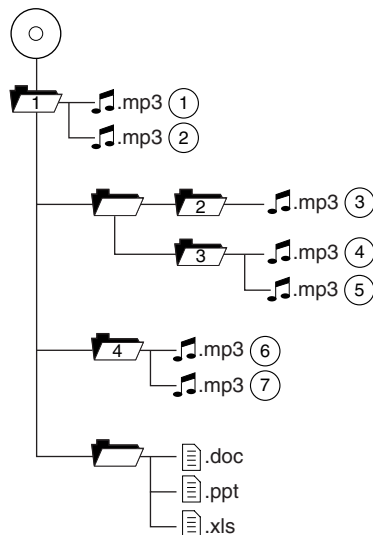

In track mode, the system will display and play the structure as if it were only one level deep (all .mp3 files will be played, regardless of being in a specific folder). In folder mode, the system will only play the .mp3 files in the current folder.

Entertainment Systems

Satellite radio information (if equipped)

Satellite radio channels: SIRIUS broadcasts a variety of music, news, sports, weather, traffic and entertainment satellite radio channels. For more information and a complete list of SIRIUS satellite radio channels, visit www.sirius.com in the United States, www.sirius-canada.ca in Canada, or call SIRIUS at 1-888-539-7474.

Satellite radio reception factors: To receive the satellite signal, your vehicle has been equipped with a satellite radio antenna located on the roof of your vehicle. The vehicle roof provides the best location for an unobstructed, open view of the sky, a requirement of a satellite radio system. Like AM/FM, there are several factors that can affect satellite radio reception performance:

- **Antenna obstructions:** For optimal reception performance, keep the antenna clear of snow and ice build-up and keep luggage and other material as far away from the antenna as possible.
- **Terrain:** Hills, mountains, tall buildings, bridges, tunnels, freeway overpasses, parking garages, dense tree foliage and thunderstorms can interfere with your reception.
- **Station overload:** When you pass a ground based broadcast repeating tower, a stronger signal may overtake a weaker one and result in an audio mute.

Unlike AM/FM audible static, you will hear an audio mute when there is a satellite radio signal interference. Your radio display may display NO SIGNAL to indicate the interference.

SIRIUS satellite radio service: SIRIUS Satellite Radio is a subscription based satellite radio service that broadcasts music, sports, news and entertainment programming. A service fee is required in order to receive SIRIUS service. Vehicles that are equipped with a factory installed SIRIUS Satellite Radio system include:

- Hardware and limited subscription term, which begins on the date of sale or lease of the vehicle.
- Online media player providing access to all 65 SIRIUS music channels over the internet (U.S. customers only).

For information on extended subscription terms, contact SIRIUS at 1-888-539-7474.

Note: SIRIUS reserves the unrestricted right to change, rearrange, add or delete programming including canceling, moving or adding particular channels, and its prices, at any time, with or without notice to you. Ford Motor Company shall not be responsible for any such programming changes.

Entertainment Systems

Satellite Radio Electronic Serial Number (ESN): This 12-digit Satellite Serial Number is needed to activate, modify or track your satellite radio account. You will need this number when communicating with SIRIUS. While in Satellite Radio mode, you can view this number on the radio display by pressing AUX and Preset 1 control simultaneously.

Radio Display	Condition	Action Required
ACQUIRING	Radio requires more than two seconds to produce audio for the selected channel.	No action required. This message should disappear shortly.
SAT FAULT	Internal module or system failure present.	If this message does not clear within a short period of time, or with an ignition key cycle, your receiver may have a fault. See your authorized dealer for service.
INVALID CHNL	Channel no longer available.	This previously available channel is no longer available. Tune to another channel. If the channel was one of your presets, you may choose another channel for that preset button.
UNSUBSCRIBED	Subscription not available for this channel.	Contact SIRIUS at 1-888-539-7474 to subscribe to the channel or tune to another channel.
NO TEXT	Artist information not available.	Artist information not available at this time on this channel. The system is working properly.

Entertainment Systems

Radio Display	Condition	Action Required
NO TEXT	Song title information not available.	Song title information not available at this time on this channel. The system is working properly.
NO TEXT	Category information not available.	Category information not available at this time on this channel. The system is working properly.
NO SIGNAL	Loss of signal from the SIRIUS satellite or SIRIUS tower to the vehicle antenna.	You are in a location that is blocking the SIRIUS signal (i.e., tunnel, under an overpass, dense foliage, etc). The system is working properly. When you move into an open area, the signal should return.
UPDATING	Update of channel programming in progress.	No action required. The process may take up to three minutes.
CALL SIRIUS 1-888-539-7474	Satellite service has been deactivated by SIRIUS Satellite Radio.	Call SIRIUS at 1-888-539-7474 to re-activate or resolve subscription issues.

Family Entertainment System (if equipped)

Your vehicle may be equipped with a Family Entertainment System (FES). Refer to the *DVD Supplement Guide* for further information on your system.

NAVIGATION SYSTEM (IF EQUIPPED)

Your vehicle may be equipped with a Navigation System. Refer to the *Navigation supplement* for further information.

Climate Controls

HEATER ONLY SYSTEM (IF EQUIPPED)

1. **Fan speed adjustment:** Controls the volume of air circulated in the vehicle.

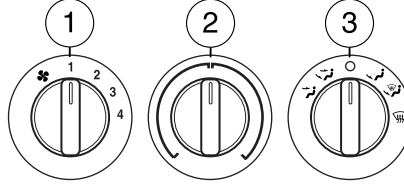

2. **Temperature selection:**

Controls the temperature of the airflow in the vehicle.

3. **Air flow selections:** Controls the direction of the airflow in the vehicle. See the following for a brief description on each control.

 : Distributes outside air through the instrument panel vents.

 : Distributes outside air through the instrument panel vents and the floor vents.



 (OFF): Outside air is shut out and the climate system is turned off.

 : Distributes outside air through the floor vents.

 : Distributes outside air through the windshield defroster vents and floor vents.

 : Distributes outside air through the windshield defroster vents and demister vents. Can be used to clear the windshield of fog and thin ice.

Operating tips

- To reduce fog build up on the windshield during humid weather, place the air flow selector in the  position.
- Do not put objects under the front seats that will interfere with the air flow to the back seats.
- To reduce humidity build-up inside the vehicle, do not drive in the  (OFF) position.
- Under normal weather conditions, do not leave the airflow selector in  (OFF). This allows the vehicle to breathe using the outside air inlets.
- Remove any snow, ice or leaves from the air intake area at the base of the windshield.

To aid in side window defogging/demisting in cold weather:

1. Select .
2. Adjust the temperature control to maintain comfort.

Climate Controls

3. Set the fan speed to the highest setting.
4. Direct the outer instrument panel vents towards the side windows.

To increase airflow to the outer instrument panel vents, close the vents located in the middle of the instrument panel.



Do not place objects on top of the instrument panel as these objects may become projectiles in a collision or sudden stop.

MANUAL HEATING AND AIR CONDITIONING SYSTEM (IF EQUIPPED)

1. Temperature selection:

Controls the temperature of the airflow in the vehicle.

2. Air flow selections: Controls the direction of the airflow in the vehicle. See the following for a brief description on each control.

MAX A/C: Distributes recirculated air through the instrument panel vents and center console vents (if equipped) to cool the vehicle. This re-cooling of the interior air is more economical and efficient. Recirculated air may also help reduce undesirable odors from entering the vehicle.

: Distributes air through the instrument panel vents and center console vents (if equipped).

: Distributes air through the instrument panel vents, center console vents (if equipped) and the floor vents.

○ (OFF): Outside air is shut out and the climate system is turned off.



: Distributes air through the floor vents.

: Distributes air through the windshield defroster vents and floor vents.

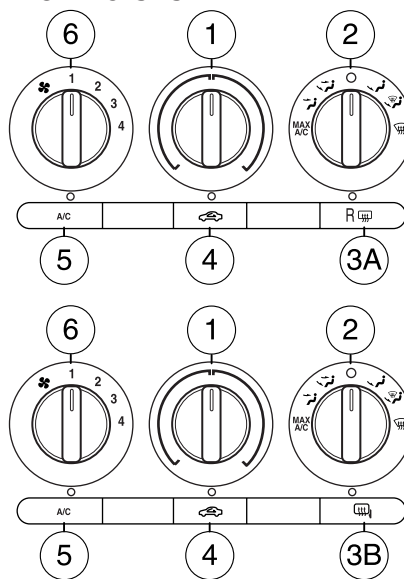

: Distributes outside air through the windshield defroster vents.



Climate Controls

3. A.  **Rear defroster (if equipped):** Press to defrost the rear window. Refer to *Rear window defroster (if equipped)* later in this chapter for more information.
3. B. **Heated mirrors (if equipped):** Press to activate/deactivate. This function will clear snow, fog and thin ice from the side rear view mirrors.
4. **Recirculation control**  : Press to activate/deactivate air recirculation in cabin. Recirculated air may reduce the amount of time to cool down the interior of the vehicle and may also help reduce undesired odors from reaching the interior of the vehicle. Recirculation engages automatically with selection of MAX A/C or can be engaged manually in any other airflow selection except defrost. Recirculation may turn off automatically in all airflow selections except MAX A/C.
5. **A/C:** Press to activate/deactivate air conditioning. Use with recirculated air to improve cooling performance. Engages automatically in MAX A/C, Defrost and Floor/Defrost.
6. **Fan speed adjustment:** Controls the volume of air circulated in the vehicle.

Operating tips

- To reduce fog build up on the windshield during humid weather, place the air flow selector in the  (defrost) or  (floor/defrost) position.
- To reduce humidity build up inside the vehicle: do not drive with the airflow selector in the  (OFF) or with recirculated air engaged.
- Do not put objects under the front seats that will interfere with the airflow to the back seats.
- Remove any snow, ice or leaves from the air intake area at the base of the windshield.
- To improve the A/C cool down, drive with the windows slightly open for 2-3 minutes after start up or until the vehicle has been “aired out.”
- For maximum cooling performance (Max A/C):



Max A/C mode:

- Move the temperature control to the coolest setting.
- Set the fan to the highest speed initially, then adjust to maintain comfort.

Panel () and panel/floor () modes:

50

Climate Controls

- Move the temperature control to the coolest setting.
- Select A/C and recirculated air (). Use recirculated air with A/C to provide colder airflow.
- Set the fan to the highest speed initially, then adjust to maintain comfort.
- To aid in side window defogging/demisting in cold weather:
 1. Select  .
 2. Select A/C.
 3. Adjust the temperature control to maintain comfort.
 4. Set the fan speed to the highest setting.
 5. Direct the outer instrument panel vents towards the side windows.

To increase airflow to the outer instrument panel vents, close the vents located in the middle of the instrument panel.



Do not place objects on top of the instrument panel as these objects may become projectiles in a collision or sudden stop.

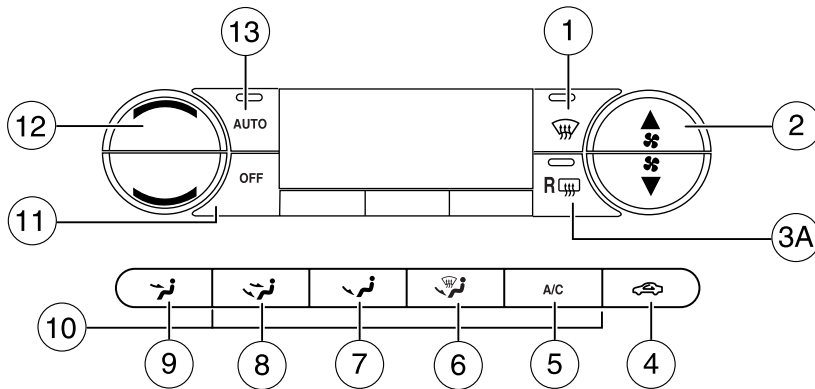

AUTOMATIC TEMPERATURE CONTROL (ATC) SYSTEM (IF EQUIPPED)



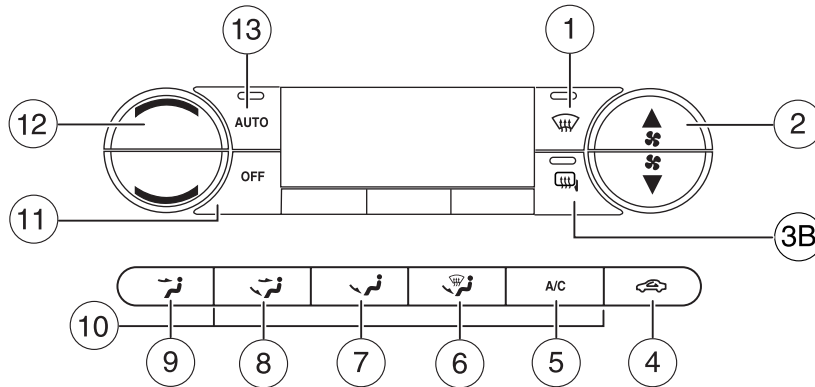

Climate Controls











Temperature conversion: To switch between Fahrenheit and Celsius: If your vehicle is equipped with a full message center, refer to *Setup menu* in the *Message center* section of the *Driver Controls* chapter for more information. If your vehicle is equipped with a mini message center, see your authorized dealer for temperature conversion.

MAX A/C: For maximum cooling performance, press , A/C, , and set the temperature to 60°F and the highest blower setting.

1.  **Defrost:** Distributes outside air through the windshield defroster vents and demister vents. Can be used to clear the windshield of fog and thin ice.
2.  **Fan speed control:** Press to manually increase or decrease the fan speed. To return to automatic fan operation, press AUTO.
3. A.  **Rear defroster:** Press to defrost the rear window. Refer to *Rear window defroster (if equipped)* in this section for more information. If your vehicle is equipped with both rear defroster and heated mirrors, the same button will activate both.
3. B. **Heated mirrors (if equipped):** Press to activate/deactivate. This feature will remove ice and snow from the side view mirrors.

Climate Controls

4.  **Recirculation control:** Press to activate/deactivate air recirculation in cabin. Recirculated air may reduce the amount of time to cool down the interior of the vehicle and may also help reduce undesired odors from reaching the interior of the vehicle. Recirculation can be engaged manually in any other airflow selection except  (defrost). Recirculation may turn off automatically.
5. **A/C control:** Press to activate/deactivate air conditioning. Use with recirculated air to improve cooling performance and efficiency. Engages automatically in AUTO,  (defrost) and  (floor/defrost).
6.  : Distributes air through the windshield defroster ducts, demister outlets, and the front and rear seat floor ducts. The system will automatically provide outside air to reduce window fogging.
7.  : Distributes air through the floor and rear seat floor ducts.
8.  : Distributes air through the windshield defroster ducts, demister outlets, and the front and rear seat floor ducts.
9.  : Distributes air through the instrument panel and center console registers (if equipped).
10. **Manual override controls:** Allows you to manually select where airflow is directed. To return to full automatic control, press AUTO.
11. **OFF:** Outside air is shut out and the fan will not operate.
12. **Temperature control:** Controls the temperature in the cabin of the vehicle. Press to increase/decrease the temperature.
13. **AUTO:** To engage automatic temperature control, press AUTO and select the desired temperature using the temperature control. The system will automatically determine fan speed, airflow location, A/C on or off, and outside or recirculated air, to heat or cool the vehicle to reach the desired temperature.



Climate Controls

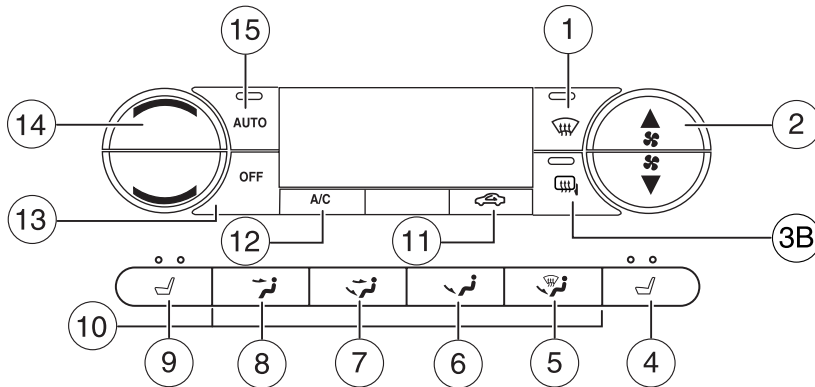
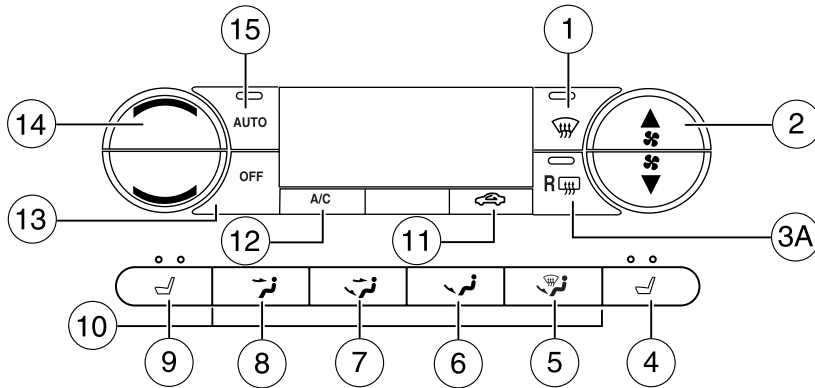









Automatic Temperature Control (ATC) system with heated seats (if equipped)





Temperature conversion: To switch between Fahrenheit and Celsius:
If your vehicle is equipped with a full message center, refer to *Units (Fahrenheit/Celsius)* in the *Driver Controls* chapter.
If your vehicle is equipped with a mini message center, refer to *Mini message center electronic compass temperature display* in the *Driver Controls* Chapter.

Climate Controls

MAX A/C: For maximum cooling performance, press , A/C, , and set the temperature to 60°F and the highest blower setting.

1.  **Defrost:** Distributes outside air through the windshield defroster vents and demister vents. Can be used to clear the windshield of fog and thin ice.
2.  **Fan speed control:** Press to manually increase or decrease the fan speed. To return to automatic fan operation, press AUTO.
3. A.  **Rear defroster:** Press to defrost the rear window. Refer to *Rear window defroster (if equipped)* in this section for more information. If your vehicle is equipped with both rear defroster and heated mirrors, the same button will activate both.
3. B. **Heated mirrors (if equipped):** Press to activate/deactivate. This feature will remove ice and snow from the side view mirrors.
4.  **Passenger heated seat control:** Press to heat the passenger seat. Press once to activate high heat (two indicator lights). Press again to activate low heat (one indicator light). Press again to deactivate the passenger heated seat.
5.  : Distributes air through the windshield defroster ducts, demister outlets, and the front and rear seat floor ducts. The system will automatically provide outside air to reduce window fogging.
6.  : Distributes air through the floor and rear seat floor ducts.
7.  : Distributes air through the windshield defroster ducts, demister outlets, and the front and rear seat floor ducts.
8.  : Distributes air through the instrument panel and center console registers (if equipped).
9.  **Driver heated seat control:** Press to heat the driver seat. Press once to activate high heat (two indicator lights). Press again to activate low heat (one indicator light). Press again to deactivate the driver heated seat.
10. **Manual override controls:** Allows you to manually select where airflow is directed. To return to full automatic control, press AUTO.
11.  **Recirculation control:** Press to activate/deactivate air recirculation in cabin. Recirculated air may reduce the amount of time to cool down the interior of the vehicle and may also help reduce undesired odors from reaching the interior of the vehicle. Recirculation can be engaged manually in any other airflow selection except  (defrost). Recirculation may turn off automatically.

Climate Controls



12. **A/C control:** Press to activate/deactivate air conditioning. Use with recirculated air to improve cooling performance and efficiency. Engages automatically in AUTO,  (defrost) and .

13. **OFF:** Outside air is shut out and the fan will not operate.



14. **Temperature control:** Press to increase/decrease the temperature in the vehicle cabin.

15. **AUTO:** To engage automatic temperature control, press AUTO and select the desired temperature using the temperature control. The system will automatically determine fan speed, airflow location, A/C on or off, and outside or recirculated air, to heat or cool the vehicle to reach the desired temperature.

Operating tips

- To reduce fog build up on the windshield during humid weather, place the air flow selector in the  position.
- To reduce humidity build up inside the vehicle: do not drive with the airflow selector in the OFF or with  (recirculated air) engaged.
- Do not put objects under the front seats that will interfere with the airflow to the back seats.
- Remove any snow, ice or leaves from the air intake area at the base of the windshield.
- To improve the A/C cool down, drive with the windows slightly open for 2-3 minutes after start up or until the vehicle has been “aired out.”
- For maximum cooling performance MAX A/C:

In AUTO : Press AUTO control and set to desired temperature.

In Manual Override Control: Press the  (panel), A/C, and  (recirculation) controls, set the temperature to 60°F and the fan to the highest blower setting.

- To aid in side window defogging/demisting in cold weather:

1. Select .
2. Select A/C.
3. Adjust the temperature control to maintain comfort.
4. Set the fan speed to the highest setting.
5. Direct the outer instrument panel vents towards the side windows.

To increase airflow to the outer instrument panel vents, close the vents located in the middle of the instrument panel.

Climate Controls



Do not place objects on top of the instrument panel as these objects may become projectiles in a collision or sudden stop.

REAR WINDOW DEFROSTER (IF EQUIPPED)

The rear defroster control is located on the climate control panel and works to defrost your rear window from fog and thin ice. If equipped, it also operates the heated mirror to remove snow and thin ice from the side mirrors.

Ensure that the ignition is ON. Press to turn the defroster ON/OFF. The indicator light will illuminate when activated.

Do not use razor blades or other sharp objects to clean the inside of the rear window or to remove decals from the inside of the rear window. This may cause damage to the heated grid lines and will not be covered by your warranty.

Lights

HEADLAMP CONTROL ☀

Rotate the headlamp control clockwise to the first position P⊖ to turn on the parking lamps. Rotate clockwise to the second position ☀ to also turn on the headlamps.

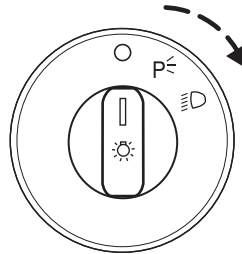

Autolamp control (if equipped) ☀

The autolamp system provides light sensitive automatic on-off control of the exterior lights normally controlled by the headlamp control.

The autolamp system also keeps the lights on for approximately 20 seconds or on vehicles equipped with a message center, you can select a delay from 0–180 seconds, after the ignition switch is turned to OFF.

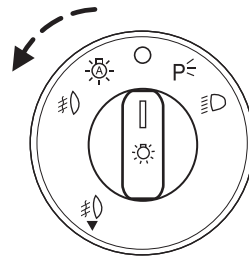

- To turn autolamps on, rotate the control counterclockwise to ☀.
- To turn autolamps off, rotate the control clockwise to P⊖.

If your vehicle is not equipped with a message center, then the auto lamps can be programmed manually by:

1. Start with the ignition in OFF and the autolamps ☀ selected.
2. Turn off the autolamps by turning the headlamp switch to P⊖.
3. Turn the ignition to ON.
4. Turn the ignition to OFF.
5. Select the autolamps by turning the headlamp switch to ☀.



Steps 2 through 5 must be performed within a 10 second period. At this point, the headlamps and park lamps will turn on.

6. Deselect the autolamps after the desired autolamp delay time (maximum of 3 minutes).

At this point, the headlamps and park lamps will turn off.

Lights

Foglamp control (if equipped)

The headlamp control also operates the foglamps. The foglamps can be turned on only when the headlamp control is in the ,  or  position and the high beams are not turned on.

Pull headlamp control towards you to turn foglamps on. The foglamp indicator light  will illuminate if the ignition is in the ON position.

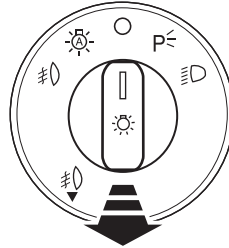

High beams

Push the lever toward the instrument panel to activate. Pull the lever towards you to deactivate.

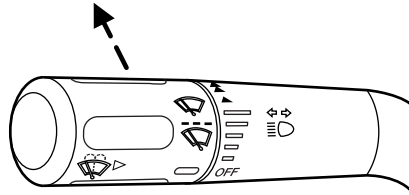

Flash to pass

Pull toward you slightly to activate and release to deactivate.

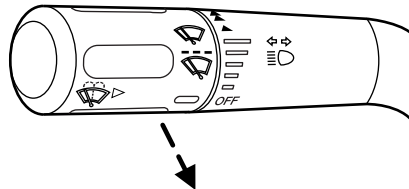

Daytime running lamps (DRL) (if equipped)

Turns the headlamps on with a reduced output.

In order for the DRLs to function:

- the ignition must be in the ON position and
- the headlamp control is in the OFF, parking lamp or autolamp position.

Lights

 Always remember to turn on your headlamps at dusk or during inclement weather. The Daytime Running Lamp (DRL) system does not activate the tail lamps and generally may not provide adequate lighting during these conditions. Failure to activate your headlamps under these conditions may result in a collision.

PANEL DIMMER CONTROL

Use to adjust the brightness of the instrument panel and all applicable switches in the vehicle during headlamp and parklamp operation.

Move the control to the full upright position, past detent, to turn on the interior lamps.

Move the control to the full down position, past detent, to prevent the interior lights from illuminating when the doors are opened.

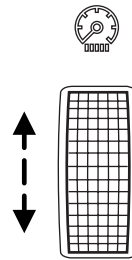

AIMING THE HEADLAMPS

The headlamps on your vehicle are properly aimed at the assembly plant. If your vehicle has been in an accident the alignment of your headlamps should be checked by your authorized dealer.

Vertical aim adjustment

1. Park the vehicle directly in front of a wall or screen on a level surface, approximately 25 feet (7.6 meters) away.

- (1) 8 feet (2.4 meters)
- (2) Center height of lamp to ground
- (3) 25 feet (7.6 meters)
- (4) Horizontal reference line

2. Measure the height from the center of your headlamp (indicated by a 3.0 mm circle on the lens) to the ground and mark an 8 foot (2.4 meter) horizontal reference line on the vertical wall or screen at this height (a piece of masking tape works well).

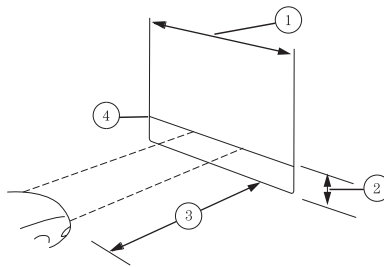

Lights

3. Turn on the low beam headlamps to illuminate the wall or screen and open the hood. Cover one of the headlamps so no light hits the wall.

4. On the wall or screen you will observe a light pattern with a distinct horizontal edge towards the right. If this edge is not at the horizontal reference line, the beam will need to be adjusted so the edge is at the same height as the horizontal reference line.

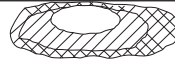

5. Locate the vertical adjuster on each headlamp, then use a 4 mm socket/wrench to turn the adjuster either counterclockwise (to adjust down) or clockwise (to adjust up) aligning the upper edge of the light pattern up to the horizontal line.

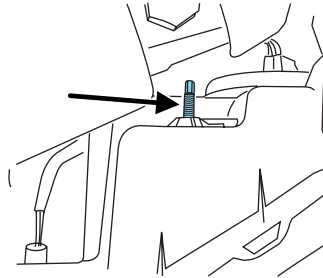

6. HORIZONTAL AIM IS NOT REQUIRED FOR THIS VEHICLE AND IS NON-ADJUSTABLE.

7. Repeat Steps 3–5 for the other headlamp.

8. Close the hood and turn off the lamps.

TURN SIGNAL CONTROL ⇐⇒

- Push down to activate the left turn signal.
- Push up to activate the right turn signal.

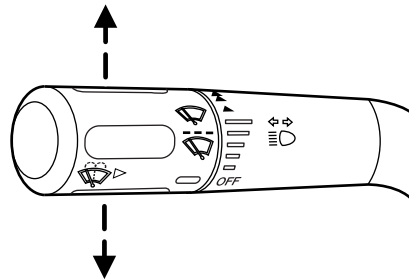

Lights

INTERIOR LAMPS

Map lamps

To turn on the map lamps, press the control next to each lamp.

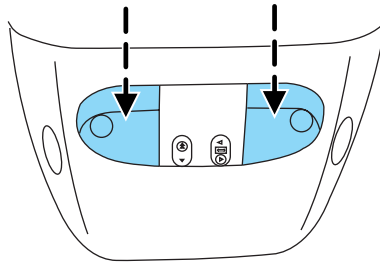

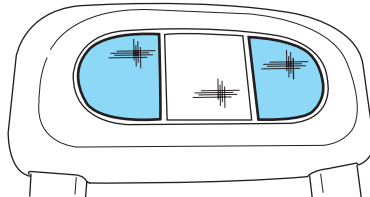

Rear map lamp (if equipped)

The rear map lamp lights are located on the end of the overhead rail system. The lamps can be turned on or off by pushing on the lens.



Rear dome lamp (if equipped)

- ON or  : The dome light will stay on.
- DOOR or middle position: The dome light will only come on if a door is opened.
- OFF or  : The lamp will not come on at all.

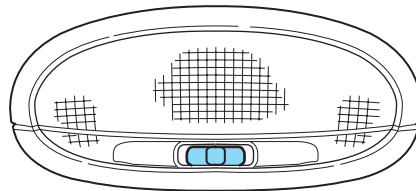

The rear dome lamp can be turned ON or OFF by sliding the control.

Lights

Dome/courtesy lamps (if equipped)

The dome lamp lights when:

- any door is opened.
- the instrument panel dimmer switch is rotated up until the courtesy lamps come on.
- any of the remote entry controls are pressed and the ignition is OFF.

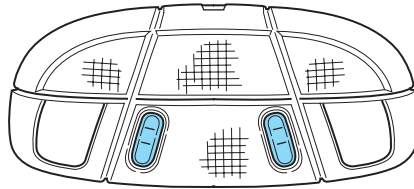

The reading portion, the two outer lights, can only be toggled on and off at the lamp.

Courtesy/reading/cargo lamps (if equipped)

The dome portion of the lamp, the center light, can be turned on when the panel dimmer control is rotated fully up or when any door is opened.

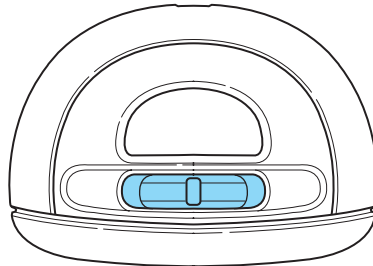

With the ignition key in the ACC or ON position, the rear dome lamp can be turned ON or OFF by sliding the control.

BULB REPLACEMENT

Headlamp Condensation

The headlamps are vented to equalize pressure. When moist air enters the headlamp(s) through the vents, there is a possibility that condensation can occur. This condensation is normal and will clear within 45 minutes of headlamp operation.

Using the right bulbs

Replacement bulbs are specified in the chart below. Headlamp bulbs must be marked with an authorized "D.O.T." for North America and an "E" for Europe to ensure lamp performance, light brightness and pattern and safe visibility. The correct bulbs will not damage the lamp assembly or void the lamp assembly warranty and will provide quality bulb burn time.

Lights

Function	Number of bulbs	Trade number
Headlamps	2	H13 / 9008
Front park/turn lamps	2	3157A (amber)
Front sidemarker	2	194
Foglamps	2	9140
Backup lamp (except Harley)	2	3156
Backup lamp (Harley)	2	3155
Rear stop/turn/sidemarker/tail lamp	2	4057K or 3057K
High-mount brakelamp	1	921
Cargo lamp	2	921
License plate lamp	2	194
Exterior mounted mirror turn signal indicator (if equipped)	2	See your dealer
Puddle lamp (if equipped)	2	See your dealer
All replacement bulbs are clear in color except where noted.		
To replace all instrument panel lights - see your authorized dealer		

Replacing exterior bulbs

Check the operation of all the bulbs frequently.

Replacing headlamp bulbs

1. Make sure that the headlamp control is in the OFF position and open the hood.
2. At the top and inboard side of the headlamp, peel the protective cover back from the lower screws and loosen the three retaining screws.
3. Once the three retaining screws have been removed, disengage the tab at the top center of the headlamp assembly by lifting it up.
4. Slide headlamp assembly forward disconnecting the snap attachment at the fender and disconnect the electrical connector from the bulb by pulling rearward.

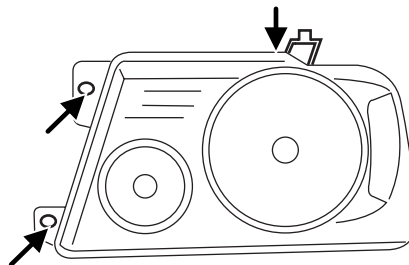

Lights

5. Remove the bulb by turning it counterclockwise, then pull it straight out.

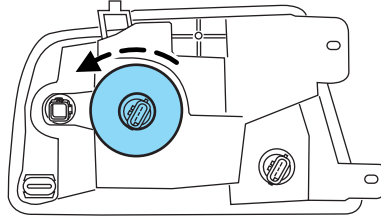

Handle a halogen headlamp bulb carefully and keep out of children's reach. Grasp the bulb only by its plastic base and do not touch the glass. The oil from your hand could cause the bulb to break the next time the headlamps are operated.

Install the new bulb in reverse order.

Replacing front parking lamp/turn signal/sidemarkers bulbs

1. Make sure the headlamp control is in the OFF position and open the hood.
2. At the top and inboard side of the headlamp, peel the protective cover back from the lower screws and loosen the three retaining screws.
3. Once the three retaining screws have been removed, disengage the tab at the top center of the headlamp assembly by lifting it up.

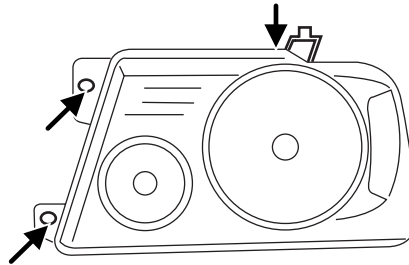

Lights

- Slide the headlamp assembly forward disconnecting the snap attachment at the fender.
- Remove bulb socket from the lamp assembly by turning it counterclockwise and then pull the bulb straight out.

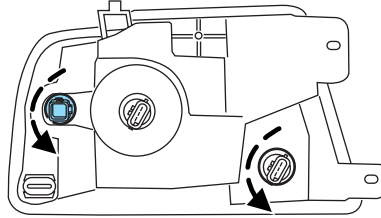

Install the new bulb(s) in reverse order.

Replacing tail/brake/turn signal/backup lamp bulbs

- Make sure the headlamp control is in the OFF position.
- Open the tailgate to expose the lamp assembly screws and remove the two screws from the tail lamp assembly.

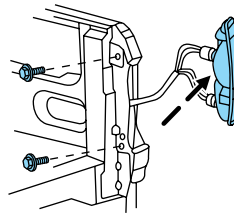

- Carefully pull the lamp assembly straight rearward from the tailgate pillar to disengage two hidden snap-in retainers. (Flare side tail lamps are not equipped with snap-in retainers.)

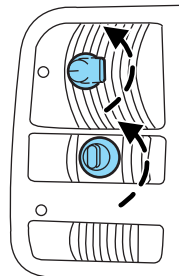

- Remove bulb socket from the lamp assembly by turning it counterclockwise.
- Pull bulb straight out of socket and press in the new bulb.

Install the new bulb(s) in reverse order.

Lights

Replacing high-mount brake and cargo lamp bulbs

Make sure the headlamp control is in the OFF position.

1. Remove the two screws and move the lamp assembly away from the vehicle to expose the bulb sockets.
2. Remove the bulb socket by rotating counterclockwise and pulling it out of the lamp assembly.

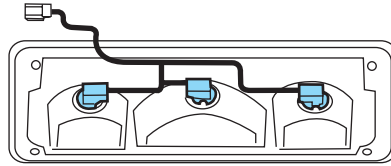

3. Pull the bulb straight out of the socket and push in the new bulb.

Install the new bulbs in reverse order.

Replacing foglamp bulbs (if equipped)

1. Make sure the headlamp control is in the OFF position.
2. Remove the bulb socket from the foglamp by turning counterclockwise.
3. Disconnect the electrical connector from the foglamp bulb.

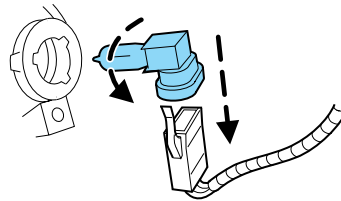

Install the new bulb in reverse order.

Replacing exterior mounted mirror turn signal indicator lamp bulbs

For bulb replacement, see your authorized dealer.

Replacing license plate lamp bulbs

The license plate bulbs are located behind the rear bumper. To change the license plate lamp bulbs:

1. Reach behind the rear bumper to locate the bulb.
2. Twist the bulb socket counterclockwise and carefully pull to remove it from the lamp assembly.
3. Pull out the old bulb from the socket and push in the new bulb.
4. Install the bulb socket in lamp assembly by turning it clockwise.

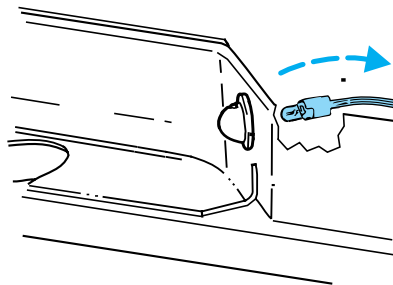

Driver Controls

MULTI-FUNCTION LEVER

Windshield wiper: Rotate the end of the control away from you to increase the speed of the wipers; rotate towards you to decrease the speed of the wipers.

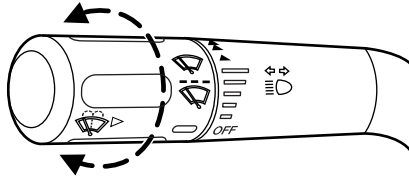

Windshield washer: Push the end of the stalk:

- briefly: causes a single swipe of the wipers without washer fluid.
- a quick push and hold: the wipers will swipe three times with washer fluid.
- a long push and hold: the wipers and washer fluid will be activated for up to ten seconds.

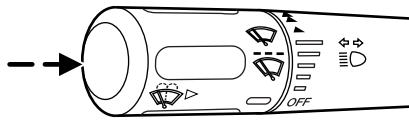

Note: Do not operate the washer when the washer reservoir is empty. This may cause the washer pump to overheat. Check the washer fluid level frequently. Do not operate the wipers when the windshield is dry. This may scratch the glass, damage the wiper blades and cause the wiper motor to burn out. Before operating the wiper on a dry windshield, always use the windshield washer. In freezing weather, be sure the wiper blades are not frozen to the windshield before operating the wipers.

TILT STEERING WHEEL (IF EQUIPPED)

Pull the lever down to unlock the steering column. While the lever is in the down position, tilt the steering column to its desired orientation.

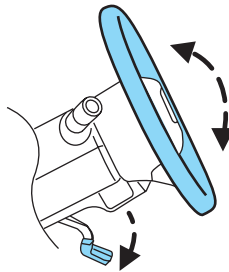

Driver Controls

While holding the steering column, pull the lever up to its original position to lock the steering column.



Never adjust the steering column when the vehicle is moving.

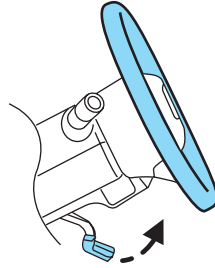

ILLUMINATED VISOR MIRROR (IF EQUIPPED)

Lift the mirror cover to turn on the visor mirror lamps.

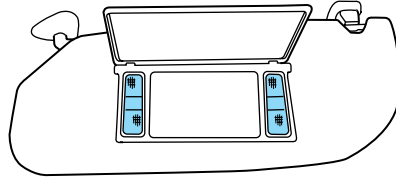

CENTER CONSOLE (IF EQUIPPED)

The center console offers several useful storage features. These include:

1. Cupholders
2. Tissue holder in lid
3. Power point
4. Large utility compartment has Coin holder slots, PalmPilot[™]/PDA holder, and Pen holder

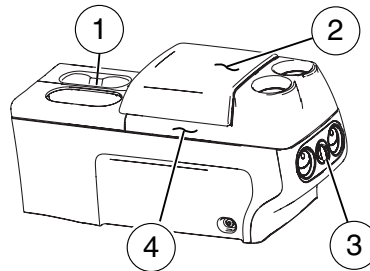

Use only soft cups in the cupholder. Hard objects can injure you in a collision.

Driver Controls

OVERHEAD CONSOLE (IF EQUIPPED)

The appearance of your vehicle's overhead console will vary according to your option package. The overhead console can come on rails, which can be removed by the customer, or it can come as a non-rail component of the headliner, which cannot be removed.

If your vehicle is equipped with a overhead console rail system, there are several features that can be operated.

1. To open the bins, move the center latch forward which will allow the door to be opened.
2. The latches on the side of the bins are to enable the user to remove the bin or add a dealer purchased feature.

Sliding the bins on the rails may cause damage to the headliner. The removable bins are to be snapped into place not slid.

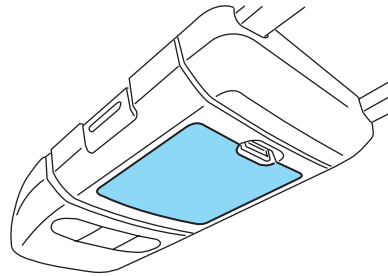

Storage compartment

Press the release on the door to open the storage compartment.

The storage compartment may be used to secure sunglasses or a similar object. The front bin may be used to store small objects.

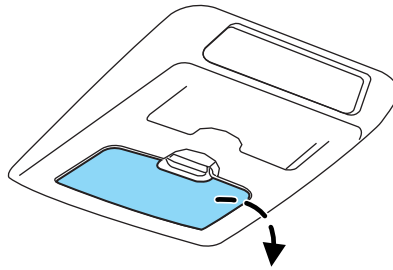

Overhead Storage Bins

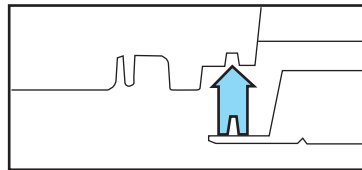
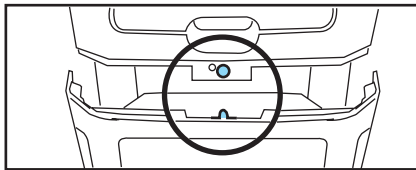

Driver Controls

- When on the overhead rail, adjacent bins must be pinned together. Bins adjacent to the End Cap must be pinned to the End Cap. Bins without pin attachments should not be placed on the overhead rail.



Failure to pin the bins together can allow the bins to become separated from the rail under certain conditions.

Bin Removal

Attach and remove bins from the rail using the following instructions:

Place both palms on the underside of the storage bin, avoiding the storage bin door.

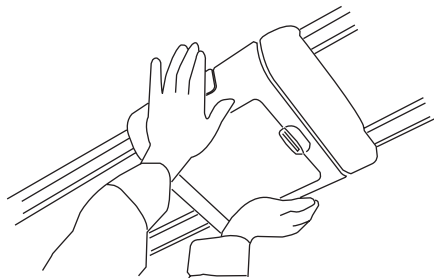

Push upwards with palms.

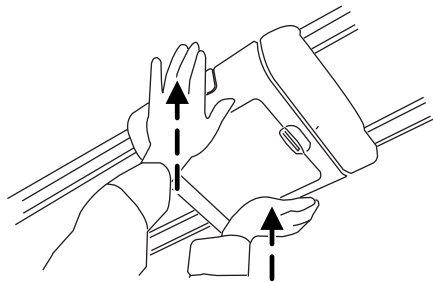

Driver Controls

While pushing upwards with palms, grip the side latches with fingers and squeeze.

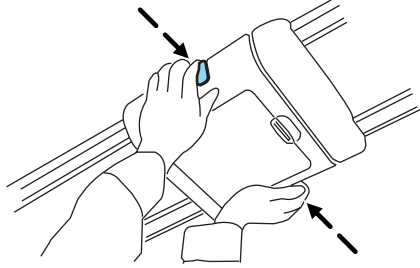

With pressure applied with palms and side latches squeezed down, pull downward on the entire storage bin and remove.

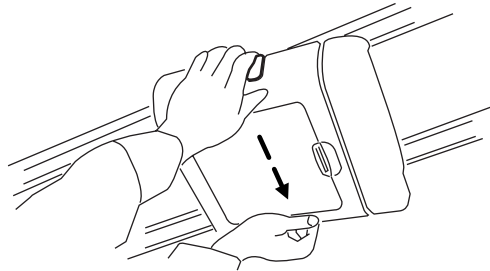

AUXILIARY POWER POINT (12VDC)

Power outlets are designed for accessory plugs only. Do not insert any other object in the power outlet as this will damage the outlet and blow the fuse. Do not hang any type of accessory or accessory bracket from the plug. Improper use of the power outlet can cause damage not covered by your warranty.

Driver Controls

The auxiliary power point is located on the instrument panel.

Do not use the power point for operating the cigarette lighter element (if equipped).

To prevent the fuse from being blown, do not use the power point(s) over the vehicle capacity of 12 VDC/180W.

To prevent the battery from being discharged, do not use the power point longer than necessary when the engine is not running.

An additional auxiliary power point is located on the lower rear side of the center console. The power point is accessible from the rear seats.

Always keep the power point caps closed when not being used.

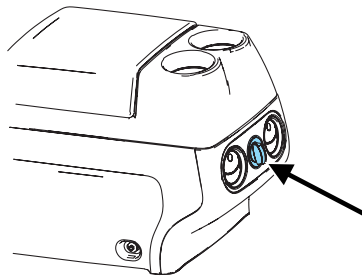
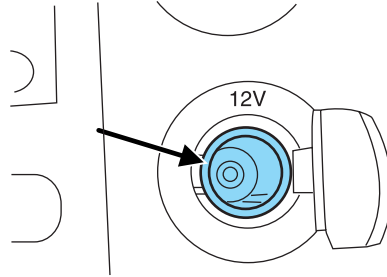

Cigarette/Cigar lighter (if equipped)

Do not plug optional electrical accessories into the cigarette lighter socket.

Do not hold the lighter in with your hand while it is heating, this will damage the lighter element and socket. The lighter will be released from its heating position when it is ready to be used.

Improper use of the lighter can cause damage not covered by your warranty.

Driver Controls

Cupholder/Ashtray (if equipped)

The cupholder/ashtray is located on the instrument panel.

To open cupholder/ashtray, push in on the door and release. The door will spring out 1/4+ inches. Then pull cupholder/ashtray assembly out the remaining distance to utilize. To close, push assembly in completely and release.

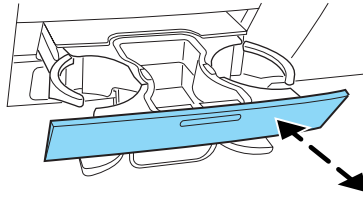

Ashtray (if equipped)

The ashtray is located on the instrument panel.

To open ashtray, push in on the door and release. The ashtray assembly will tip out. To close, push assembly in completely and release.

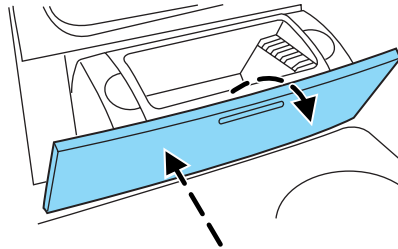

POWER WINDOWS (IF EQUIPPED)



Do not leave children unattended in the vehicle and do not let children play with the power windows. They may seriously injure themselves.



When closing the power windows, you should verify they are free of obstructions and ensure that children and/or pets are not in the proximity of the window openings.

Driver Controls

Press and hold the bottom part of the rocker switch to open the window. Press and hold the top part of the rocker switch to close the window.

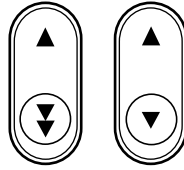

One touch down

Allows the driver's window to open fully without holding the control down. Press completely down on the bottom part of the rocker switch and release quickly. Press the rocker switch again to stop.

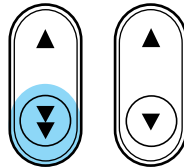

Window lock (if equipped)

The window lock feature allows only the driver to operate the power windows.

To lock out all the window controls except for the driver's press the left side of the control.

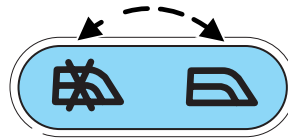

Note: The rear window switches will not illuminate when the window control is in the LOCKED position.

Press the right side to restore the window controls.

Power Sliding Back Window (if equipped)

To operate the power sliding back window, the ignition switch must be in the Run or Accessory position.

Driver Controls

- Press and hold the bottom part of the rocker switch to open window all the way to the full open position.
- Press and hold the top part of the rocker switch to close the window.

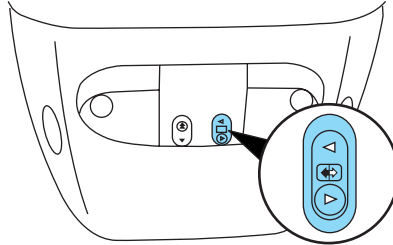

When operating the power sliding back window you must ensure all rear seat occupants and/or cargo are not in the proximity of the back window.



Do not leave children unattended in the vehicle and do not let children play with the power sliding back window, they may seriously injure themselves.

Accessory delay (if equipped)

With accessory delay, the window switches may be used for up to ten minutes after the ignition switch is turned to the OFF position or until any door is opened.

AUTOMATIC DIMMING INSIDE REAR VIEW MIRROR (IF EQUIPPED)

Your vehicle is equipped with an inside rear view mirror with an auto-dimming function (available as an option on the outside driver's side mirror). The electronic day/night mirror will change from the normal (high reflective) state to the non-glare (darkened) state when bright lights (glare) reach the mirror. When the mirror detects bright light from behind the vehicle, it will automatically adjust (darken) to minimize glare.

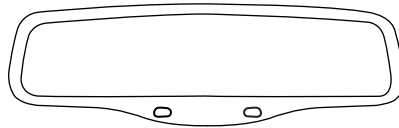

The mirror will automatically return to the normal state whenever the vehicle is placed in R (Reverse) to ensure a bright clear view when backing up.

Do not block the sensor on the backside of the inside rear view mirror since this may impair proper mirror performance.

Driver Controls

EXTERIOR MIRRORS

Power side view mirrors

To adjust your mirrors:

1. Rotate the control clockwise to adjust the right mirror and rotate the control counterclockwise to adjust the left mirror.
2. Move the control in the direction you wish to tilt the mirror.
3. Return to the center position to lock mirrors in place.

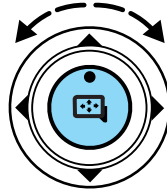

Fold-away mirrors (if equipped)

Fold the side mirrors in carefully before driving through a narrow space, like an automatic car wash.

If equipped with powerfold mirrors, you can fold the side mirrors using the power mirror switch.

1. Rotate the switch to the center/neutral position.
2. Momentarily pull the switch rearward to auto fold in.
3. Momentarily pull the switch rearward again to fold back to design position.

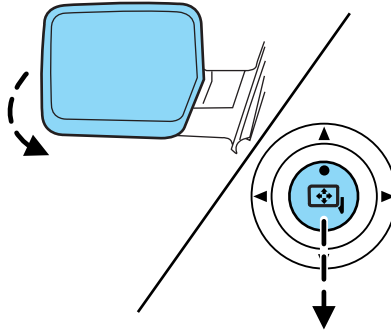

The powerfold mirrors may be moved inward/outward manually, however, if a mirror is moved manually, it will need to be reset. To reset: with the switch in the center position, momentarily pull the switch rearward to fold the mirrors in. An audible "click" will be heard indicating re-synchronization. If the click is not heard, use the switch to fold the mirrors out, then in, until the click is heard. After that, the mirrors will operate to their normal positions until they are again moved manually.

Note: Ten or more switch activations within 1 minute, or repeated folding/unfolding of the mirrors while holding the switch rearward during the full travel may cause the system to disable the fold/unfold function to protect motors from overheating. Should this occur, wait approximately 3 minutes for the system to reset and function to return to normal.

Driver Controls

Heated outside mirrors (if equipped)

Heated mirrors remove ice, mist and fog. To activate the heated mirrors, press the rear defrost button  located on the climate control panel.

Refer to *Rear Window Defrost* in the *Climate Controls* chapter for more information.

On vehicles not equipped with rear defrost, press the heated mirror control located on the climate control panel, refer to the *Climate Controls* chapter for more information.

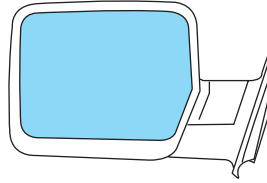

Do not remove ice from the mirrors with a scraper or attempt to readjust the mirror glass if it is frozen in place. These actions could cause damage to the glass and mirrors.

Exterior mounted mirror turn signal indicator (if equipped)

When the vehicle turn signal is activated, the lower portion of the mirror housing will blink.

This feature provides an indicator to the driver that the vehicle turn signal is working properly.

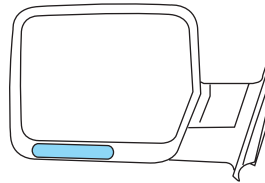

POWER ADJUSTABLE FOOT PEDALS (IF EQUIPPED)

The accelerator and brake pedal should only be adjusted when the vehicle is stopped and the gearshift lever is in the P (Park) position.

Press and hold the rocker control to adjust accelerator and brake pedal.

- Press the bottom of the control to adjust the pedals toward you.
- Press the top of the control to adjust the pedals away from you.

The adjustment allows for approximately 3 inches (76 mm) of maximum travel.

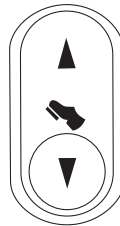

Driver Controls



Never adjust the accelerator and brake pedal with feet on the pedals while the vehicle is moving.

SPEED CONTROL (IF EQUIPPED)

With speed control set, you can maintain a speed of 30 mph (48 km/h) or more without keeping your foot on the accelerator pedal. Speed control does not work at speeds below 30 mph (48 km/h).



Do not use the speed control in heavy traffic or on roads that are winding, slippery or unpaved.

Setting speed control

The controls for using your speed control are located on the steering wheel for your convenience.

1. Press the ON control and release it.

2. Accelerate to the desired speed.

3. Press the SET control and release it.

4. Take your foot off the accelerator pedal.

5. The indicator  light on the instrument cluster will turn on.

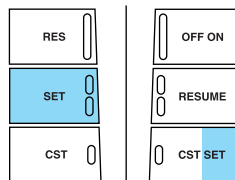
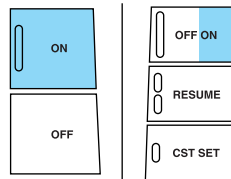

Note:

- Vehicle speed may vary momentarily when driving up and down a steep hill.
- If the vehicle speed increases above the set speed on a downhill, you may want to apply the brakes to reduce the speed.
- If the vehicle speed decreases more than 10 mph (16 km/h) below your set speed on an uphill, your speed control will disengage.

Driver Controls

Resuming a set speed

Press the RES/RESUME control and release it. This will automatically return the vehicle to the previously set speed. The RES/RESUME control will not work if the vehicle speed is not faster than 30 mph (48 km/h).

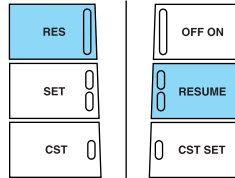

Increasing speed while using speed control

There are two ways to set a higher speed:

- Press and hold the SET control until you get to the desired speed, then release the control. You can also use the SET control to operate the Tap-Up function. Press and release this control to increase the vehicle set speed in small amounts by 1 mph (1.6 km/h).
- Use the accelerator pedal to get to the desired speed. When the vehicle reaches that speed press and release the SET control.

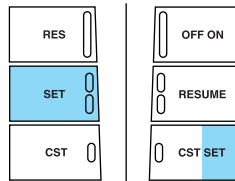

Reducing speed while using speed control

There are two ways to reduce a set speed:

- Press and hold the CST (coast) control until you get to the desired speed, then release the control. You can also use the CST control to operate the Tap-Down function. Press and release this control to decrease the vehicle set speed in small amounts by 1 mph (1.6 km/h).

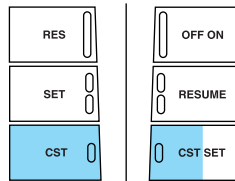

Driver Controls

- Depress the brake pedal until the desired vehicle speed is reached, press the SET control.

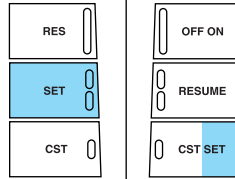

Turning off speed control

There are two ways to turn off the speed control:

- Depress the brake pedal or the clutch pedal (if equipped). This will not erase your vehicle's previously set speed, if RES/RESUME is then selected, the vehicle will return to the previously set speed.
- Press the speed control OFF control. This will erase your vehicle's previously set speed.

Note: When you turn off the speed control or the ignition, your speed control set speed memory is erased.

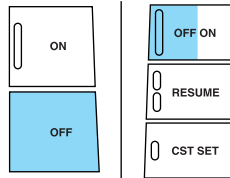

STEERING WHEEL CONTROLS (IF EQUIPPED)

These controls allow you to operate some radio and climate control features.

Audio control features

Press  to select:

- AM, FM1, FM2 (if equipped)
- CD (if equipped)
- FES/DVD (if equipped)
- AUX (IN LINE) (if equipped)
- SAT1, SAT2 or SAT3 (Satellite Radio mode if equipped).

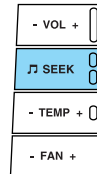

In AM, FM1, or FM2 mode:

- Press and release SEEK to select the next preset station or press and hold SEEK to select the next strong station within the selected radio band.

Driver Controls

In Satellite Radio mode (if equipped):

- Press and release SEEK to advance through preset channels or press and hold SEEK to increment to the next subscribed channel.

In CD mode:

- Press and release SEEK to select the next track selection on the CD or press and hold SEEK to fast forward in the current track selection.

In any mode:

- Press VOL + or - to adjust volume.

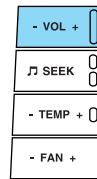

Climate control features

Press TEMP + or - to adjust temperature.

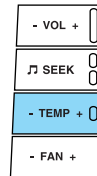

Press FAN + or - to adjust fan speed.

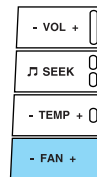

MOON ROOF (IF EQUIPPED)

The moon roof control is located on the overhead console.





Do not let children play with the moon roof or leave children unattended in the vehicle. They may seriously hurt themselves.

Driver Controls



 When closing the moon roof, you should verify that it is free of obstructions and ensure that children and/or pets are not in the proximity of the moon roof opening.

Note: The moon roof will open to the “comfort” position first before opening all the way. The “comfort” position helps to alleviate rumbling wind noise which may happen in the vehicle with the roof fully opened.

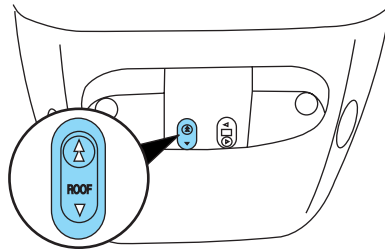
To open the moon roof: The moon roof is equipped with a one-touch open feature. Press and release the  control. The moon roof will open to the “comfort” position. Press and release the control again to fully open. To stop the one-touch open feature press either the  or  control again.



To close the moon roof: Press and hold the  control until the glass panel stops at the “comfort” position. Press and hold the control again until the glass stops moving. When fully closed, the rear portion of the glass panel will appear higher than the front portion.

To vent the moon roof: Press and hold the  control. **The moon roof must be in the closed position in order to move it into the vent position.** To close, press and hold the  control until the glass panel stops moving.

The moon roof has a built-in sliding shade that can be manually opened or closed when the glass panel is shut. To close the shade, pull it toward the front of the vehicle.

HOMELINK® WIRELESS CONTROL SYSTEM (IF EQUIPPED)

The HomeLink® Wireless Control System, located on the driver's visor, provides a convenient way to replace up to three hand-held transmitters with a single built-in device. This feature will learn the radio frequency codes of most transmitters to operate garage doors, entry gate operators, security systems, entry door locks, and home or office lighting.

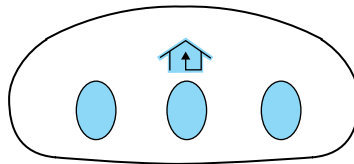

Driver Controls



When programming your HomeLink® Wireless Control System to a garage door or gate, be sure that people and objects are out of the way to prevent potential harm or damage.

Do not use the HomeLink® Wireless Control System with any garage door opener that lacks safety stop and reverse features as required by U.S. federal safety standards (this includes any garage door opener model manufactured before April 1, 1982). A garage door which cannot detect an object, signaling the door to stop and reverse, does not meet current U.S. federal safety standards. For more information, contact HomeLink® at: **www.homelink.com** or **1-800-355-3515**.

Retain the original transmitter for use in other vehicles as well as for future programming procedures (i.e. new HomeLink® equipped vehicle purchase). It is also suggested that upon the sale of the vehicle, the programmed HomeLink® buttons be erased for security purposes, refer to *Programming* in this section.

Programming

Do not program HomeLink® with the vehicle parked in the garage.

Note: Your vehicle may require the ignition switch to be turned to the ACC position for programming and/or operation of the HomeLink®. It is also recommended that a new battery be placed in the hand-held transmitter of the device being programmed to HomeLink® for quicker training and accurate transmission of the radio-frequency signal.

1. Press and hold the two outside buttons releasing only when the indicator light begins to flash after 20 seconds. **Do not** repeat Step 1 to program additional hand-held transmitters to the remaining two HomeLink® buttons. This will erase previously programmed hand-held transmitter signals into HomeLink®.

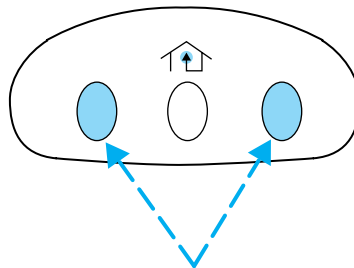

2. Position the end of your hand-held transmitter 1–3 inches (2–8 cm) away from the HomeLink® button you wish to program (located on your visor) while keeping the indicator light in view.

Driver Controls

3. Simultaneously press and hold both the HomeLink® and hand-held transmitter button. **Do not release the buttons until Step 4 has been completed.**

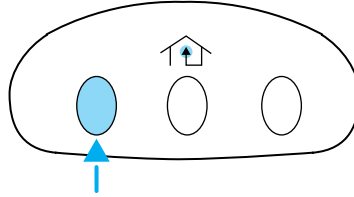

Some entry gates and garage door openers may require you to replace Step 3 with procedures noted in the “Gate Operator and Canadian Programming” in this section for Canadian residents.

4. The indicator light will flash slowly and then rapidly. Release both buttons when the indicator light flashes rapidly. (The rapid flashing light indicates acceptance of the hand-held transmitters’ radio frequency signals.)

5. Press and hold the just-trained HomeLink® button and observe the indicator light. If the light is constant, programming is complete and your device should activate when the HomeLink® button is pressed and released. **Note:** To program the remaining two HomeLink® buttons, begin with Step 2 in the “Programming” section — **do not** repeat Step 1.

Note: If the indicator light blinks rapidly for two seconds and then turns to a continuous red, proceed with Steps 6 through 8 to complete programming of a rolling code equipped device.

6. At the garage door opener receiver (motor-head unit) in the garage, locate the “learn” or “smart” button (usually near where the hanging antenna wire is attached to the unit).

7. Press and release the “learn” or “smart” button. (The name and color of the button may vary by manufacturer.)

Note: There are 30 seconds in which to initiate Step 8.

8. Return to the vehicle and firmly press, hold for two seconds and release the HomeLink® button. Repeat the press/hold/release sequence again, and, depending on the brand of the garage door opener (or other rolling code equipped device), repeat this sequence a third time to complete the programming.

HomeLink® should now activate your rolling code equipped device. To program additional HomeLink® buttons begin with Step 2 in the “Programming” section. For questions or comments, please contact HomeLink at **www.homelink.com** or **1-800-355-3515**.

Driver Controls

Gate Operator & Canadian Programming

During programming, your hand-held transmitter may automatically stop transmitting — not allowing enough time for HomeLink® to accept the signal from the hand-held transmitter.

After completing Steps 1 and 2 outlined in the “Programming” section, replace Step 3 with the following:

Note: If programming a garage door opener or gate operator, it is advised to unplug the device during the “cycling” process to prevent overheating.

- Continue to press and hold the HomeLink® button (note Step 3 in the “Programming” section) while you press and release — **every two seconds** (“cycle”) your hand-held transmitter until the frequency signal has been accepted by the HomeLink®. The indicator light will flash slowly and then rapidly after HomeLink® accepts the radio frequency signal.
- Proceed with Step 4 in the “Programming” section.

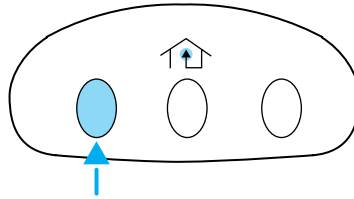

Operating the HomeLink® Wireless Control System

To operate, simply press and release the appropriate HomeLink® button. Activation will now occur for the trained product (garage door, gate operator, security system, entry door lock, or home or office lighting etc.). For convenience, the hand-held transmitter of the device may also be used at any time. In the event that there are still

programming difficulties, contact HomeLink® at www.homelink.com or **1-800-355-3515**.

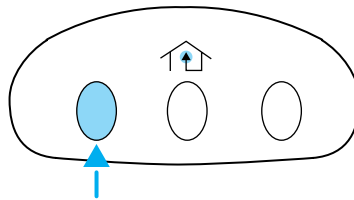

Driver Controls

Erasing HomeLink® buttons

To erase the three programmed buttons (individual buttons cannot be erased):

- Press and hold the two outer HomeLink® buttons until the indicator light begins to flash-after 20 seconds. Release both buttons. Do not hold for longer than 30 seconds.

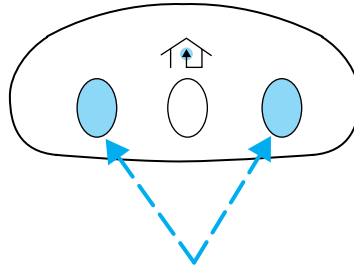

HomeLink® is now in the train (or learning) mode and can be programmed at any time beginning with Step 2 in the “Programming” section.

Reprogramming a single HomeLink® button

To program a device to HomeLink® using a HomeLink® button previously trained, follow these steps:

1. Press and hold the desired HomeLink® button. **Do NOT** release the button.
2. The indicator light will begin to flash after 20 seconds. Without releasing the HomeLink® button, follow Step 2 in the “Programming” section.

For questions or comments, contact HomeLink® at www.homelink.com or **1-800-355-3515**.

MINI MESSAGE CENTER ELECTRONIC COMPASS/TEMPERATURE DISPLAY (IF EQUIPPED)

Outside air temperature

The outside temperature display is contained in the instrument cluster and displays all the time, except when a warning message is present.



To turn the display off or change the display from English to Metric see your authorized dealer.

Compass

The compass reading may be affected when you drive near large buildings, bridges, power lines and powerful broadcast antennas. Magnetic or metallic objects placed in, on or near the vehicle may also affect compass accuracy.

Driver Controls

Usually, when something affects the compass readings, the compass will correct itself after a few days of operating your vehicle in normal conditions. If the compass still appears to be inaccurate, a manual calibration may be necessary. Refer to *Compass calibration adjustment*.

Most geographic areas (zones) have a magnetic north compass point that varies slightly from the northerly direction on maps. This variation is four degrees between adjacent zones and will become noticeable as the vehicle crosses multiple zones. A correct zone setting will eliminate this error. Refer to *Compass zone adjustment*.

Compass zone adjustment

1. Determine which magnetic zone you are in for your geographic location by referring to the zone map.
2. Turn ignition to the ON position.
3. Start the engine.

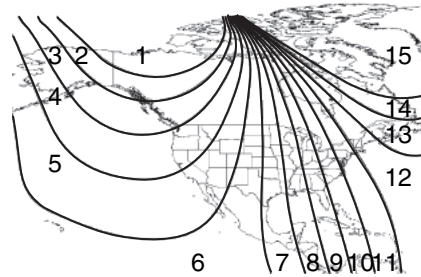

4. Press the ODO reset button in the cluster, hold for six seconds and release. You will see that ZONE appears in the instrument cluster display.

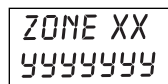

5. Press and release the button until the desired zone number appears.

Note: The range of zone values are from 01 to 15 and “wraps” back to 01.

6. When you get to the desired ZONE number, hold the button down to “lock in” the new value.

The cluster display will return to the “normal” mode when the button has not been pressed for 6 seconds.

Compass calibration adjustment

Perform this adjustment in an open area free from steel structures and high voltage lines. For optimum calibration, turn off all electrical accessories (heater/air conditioning, wipers, etc.) and make sure all vehicle doors are shut.

Driver Controls

1. Start the vehicle.
2. To enter the compass calibration mode, press and hold the button for greater than eight seconds. The display will then show CAL in the display window.
3. Drive the vehicle slowly (less than 3 mph [5 km/h]) in circles until CAL indicator turns off. As many as 5 complete circles may be required.
4. The compass is now calibrated.

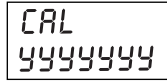

CAL
YYYYYYYY

MESSAGE CENTER (IF EQUIPPED)

With the ignition in the ON position, the message center, located on your instrument cluster, displays important vehicle information

through a constant monitor of vehicle systems. You may select

display features on the message center for a display of status preceded by a brief indicator chime. The system will also notify you of potential vehicle problems with a display of system warnings followed by a long indicator chime. If equipped with an outside temperature display, it will display in the instrument cluster all the time, except when a warning message is present.



NW 888888mi

Selectable features

Reset

Press this control to select and reset functions shown in the INFO menu and SETUP menu.

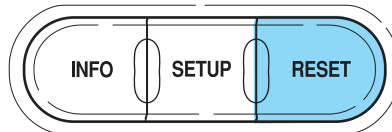

Info menu

This control displays the following control displays:

- Odometer/Compass
- Trip odometer/Odometer/Compass
- Distance to Empty

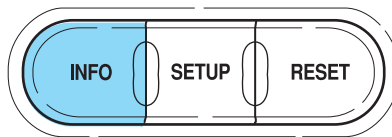

Driver Controls

- Average Fuel Economy
- Trip Elapsed Drive Time

Odometer/Trip odometer

Refer to *Gauges* in the *Instrument Cluster* chapter.

Compass display

The compass reading may be affected when you drive near large buildings, bridges, power lines and powerful broadcast antenna. Magnetic or metallic objects placed in, on or near the vehicle may also affect compass accuracy.

Usually, when something affects the compass readings, the compass will correct itself after a few days of operating your vehicle in normal conditions. If the compass still appears to be inaccurate, a manual calibration may be necessary. Refer to *Compass zone/calibration adjustment*.

Most geographic areas (zones) have a magnetic north compass point that varies slightly from the northerly direction on maps. This variation is four degrees between adjacent zones and will become noticeable as the vehicle crosses multiple zones. A correct zone setting will eliminate this error. Refer to *Compass zone/calibration adjustment*.

Compass zone/calibration adjustment

1. Determine your magnetic zone by referring to the zone map.
2. Turn ignition to the ON position.
3. Start the engine.
4. From Info menu, select the Compass/Odometer function. (Do not select Trip, DTE, or AFE. The top of the message center must be blank).
5. Press and hold the SETUP and RESET controls until the message center display changes to show the current zone setting (XX).

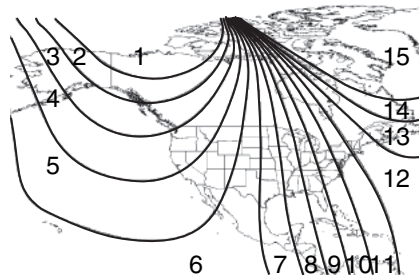

RESET FOR ZONE
INFO TO EXIT

Driver Controls

6. Press the RESET, then press SETUP control repeatedly until the correct zone setting for your geographic location is displayed on the message center. The range of zone values are from 01 to 15 and “wraps” back to 01.

SETUP ZONE XX
RESET IF DONE

7. To exit the zone setting mode, and to “lock in” your change, press and release the RESET control.

RESET FOR CAL
INFO TO EXIT

Perform compass calibration in an open area free from steel structures and high voltage lines. For optimum calibration, turn off all electrical accessories (heater/air conditioning, wipers, etc.) and make sure all vehicle doors are shut.

8. Press the RESET control to start the compass calibration function.

CIRCLE SLOWLY
TO CALIBRATE

9. Slowly drive the vehicle in a circle (less than 3 mph [5 km/h]) until the CIRCLE SLOWLY TO CALIBRATE display changes to CALIBRATION COMPLETED. It will take up to five circles to complete calibration.

10. The compass is now calibrated.

CALIBRATION
COMPLETED

Distance to empty (DTE)

Selecting this function from the INFO menu estimates approximately how far you can drive with the fuel remaining in your tank under normal driving conditions.

XXX MILES TO E
NW 888888 mi

Remember to turn the ignition OFF when refueling to allow this feature to correctly detect the added fuel.

The DTE function will display LOW FUEL LEVEL and sound a tone for one second when you have approximately 50 miles (80 km) to empty. If you RESET this warning message, this display and tone will return within 10 minutes.

Driver Controls

DTE is calculated using a running average fuel economy, which is based on your recent driving history of 500 miles (800 km). This value is not the same as the average fuel economy display. The running average fuel economy is reinitialized to a factory default value if the battery is disconnected.

Average fuel economy (AFE)

Select this function from the INFO menu to display your average fuel economy in miles/gallon or liters/100 km.



XX.X MPG
NW 888888 mi

If you calculate your average fuel economy by dividing gallons of fuel used by 100 miles traveled (kilometers traveled by liters used), your figure may be different than displayed for the following reasons:

- Your vehicle was not perfectly level during fill-up
- Differences in the automatic shut-off points on the fuel pumps at service stations
- Variations in top-off procedure from one fill-up to another
- Rounding of the displayed values to the nearest 0.1 gallon (liter)

1. Drive the vehicle at least 5 miles (8 km) with the speed control system engaged to display a stabilized average.

2. Record the highway fuel economy for future reference.

It is important to press the RESET control after setting the speed control to get accurate highway fuel economy readings.

Trip elapsed drive time

Select this function from the INFO menu to display a timer.

To operate the Trip Elapsed Drive Time perform the following:

1. Press and release RESET in order to start the timer.
2. Press and release RESET to pause the timer.
3. Press and hold RESET for 2 seconds in order to reset the timer.



TIME XX:XX:XX
NW 000000.0 mi

Driver Controls

Setup menu

Press this control for the following displays:

- System Check
- Units (English/Metric)
- Autolock
- Autolamp Delay
- Language

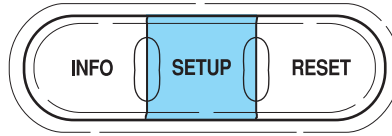

System check

Selecting this function from the SETUP menu causes the message center to cycle through each of the systems being monitored. For each of the monitored systems, the message center will indicate either an OK message or a warning message for three seconds.

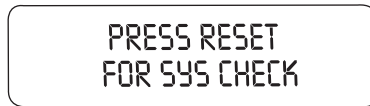

Pressing the RESET control cycles the message center through each of the systems being monitored.

The sequence of the system check report and how it appears in the message center is as follows:

1. FUEL LEVEL
2. ENGINE TEMP
3. OIL PRESSURE
4. BRAKE FLUID LEVEL
5. CHARGING SYSTEM

Units (English/Metric)

1. Select this function from the SETUP menu for the current units to be displayed.
2. Press the RESET control to change from English to Metric.

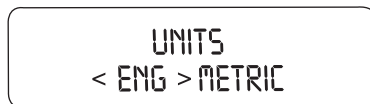

Autolocks

This feature automatically locks all vehicle doors when the vehicle is shifted into any gear, putting the vehicle in motion.

Driver Controls

1. To disable/enable the autolock feature, select this function from the SETUP control for the current display mode.

AUTO LOCKS
< ON > OFF

2. Press the RESET control to turn the autolocks ON or OFF.

Autolamp delay

This feature keeps your headlights on for up to three minutes after the ignition is switched off.

1. To disable/enable the autolamp delay feature, select this function from the SETUP control for the current display mode.

AUTOLAMP
DELAY = XXX SEC

2. Press the RESET control to select the new Autolamp delay values of >0, >10, >20, >30, >60, >90, >120 or >180.

Language

1. Select this function from the SETUP menu for the current language to be displayed.

ENGLISH
RESET FOR NEW

2. Pressing the RESET control cycles the message center through each of the language choices.

FOR ENGLISH
HOLD RESET

3. Press and hold the RESET control to set the language choice.

SET TO
ENGLISH

System warnings

System warnings alert you to possible problems or malfunctions in your vehicle's operating systems.

In the event of a multiple warning situation, the message center will cycle the display to show all warnings by displaying each one for 4 seconds.

Driver Controls

The message center will display the last selected feature if there are no more warning messages. This allows you to use the full functionality of the message center after you acknowledge the warning by pressing the RESET control and clearing the warning message.

Warning messages that have been reset are divided into two categories:

- They will reappear on the display ten minutes from the reset.
- They will not reappear until an ignition OFF-ON cycle has been completed.

This acts as a reminder that these warning conditions still exist within the vehicle.

Warning display	Status
Door ajar	Warning can be reset
Low fuel level	Warning returns after 10 minutes
Check charging system	
Check traction control [®]	
Low brake fluid level	
Low oil pressure	
Check engine temperature	
Reduced engine power	
Stop engine safely	
Check fuel cap	
Transmission malfunction	
Low tire pressure (if equipped)	
Tire pressure monitor fault (if equipped)	
Tire pressure sensor fault (if equipped)	
Engine failsafe mode	

DOOR AJAR. Displayed when a door is not completely closed.

TRANSMISSION MALFUNCTION. Displayed when the transmission is not operating properly. If the warning stays on or continues to come on, contact your authorized dealer as soon as possible.

CHECK ENGINE TEMPERATURE. Displayed when the engine coolant is overheating. Stop the vehicle as soon as safely possible, turn off the engine and let it cool. Check the coolant and coolant level. Refer

Driver Controls

to *Engine coolant* in the *Maintenance and Specifications* chapter. If the warning stays on or continues to come on, contact your authorized dealer as soon as possible.



Never remove the coolant reservoir cap while the engine is running or hot.

REDUCED ENGINE POWER. Displayed when the engine is overheating. Stop the vehicle as soon as safely possible, turn off the engine. If the warning stays on or continues to come on, contact your authorized dealer as soon as possible.

STOP ENGINE SAFELY. Displayed when the engine is overheating. Stop the vehicle as soon as safely possible, turn off the engine. If the warning stays on or continues to come on, contact your authorized dealer as soon as possible.

LOW FUEL LEVEL. Displayed as an early reminder of a low fuel condition.

CHECK CHARGING SYSTEM. Displayed when the electrical system is not maintaining proper voltage. If you are operating electrical accessories when the engine is idling at a low speed, turn off as many of the electrical loads as soon as possible. If the warning stays on or comes on when the engine is operating at normal speeds, have the electrical system checked as soon as possible.

CHECK TRACTION CONTROL™. Displayed when the Traction Control™ system is not operating properly. If this message is displayed on the message center the Traction Control™ system will be partially operable. If this warning stays on, contact your authorized dealer for service as soon as possible. For further information, refer to *Traction control™* in the *Driving* chapter.

LOW BRAKE FLUID LEVEL. Indicates the brake fluid level is low and the brake system should be inspected immediately. Refer to *Brake fluid reservoir* in the *Maintenance and Specifications* chapter.

LOW OIL PRESSURE. Displayed when the engine oil pressure is low. If this warning message is displayed, check the level of the engine oil. Refer to *Engine oil* in the *Maintenance and Specifications* chapter for information about adding engine oil. If the oil level is OK and this warning persists, shut down the engine immediately and contact your authorized dealer for service.

CHECK FUEL CAP. Displayed when the fuel filler cap is not properly installed. Check the fuel filler cap for proper installation. Refer to *Fuel filler cap* under the *Fuel Information* section in the *Maintenance and Specifications* chapter.

Driver Controls

LOW TIRE PRESSURE (if equipped). Displayed when one or more tires on your vehicle have low tire pressure. Refer to *Inflating Your Tires* in the *Tires, Wheels and Loading* chapter.

TIRE PRESSURE MONITOR FAULT (if equipped). Displayed when the Tire Pressure Monitoring System is malfunctioning. If the warning stays on or continues to come on, have the system inspected by your authorized dealer.

TIRE PRESSURE SENSOR FAULT (if equipped). Displayed when a tire pressure sensor is malfunctioning, or your spare tire is in use. For more information on how the system operates under these conditions, refer to *Understanding Your Tire Pressure Monitoring System* in the *Tires, Wheels and Loading* chapter. If the warning stays on or continues to come on, have the system inspected by your authorized dealer.

ENGINE FAILSAFE MODE. Displayed when the engine has defaulted to a 'limp-home' operation. If the warning stays on or continues to come on, contact your authorized dealer as soon as possible.

DATA ERR. These messages indicate improper operation of the vehicle network communication between electronic modules.

- Fuel computer
- Charging system
- Autolamp delay
- Auto locks
- Brake fluid
- Compass
- Outside temperature
- Engine sensor

Contact your authorized dealer as soon as possible if these messages occur on a regular basis.

POSITIVE RETENTION FLOOR MAT



Do not install additional floor mats on top of the factory installed floor mats as they may interfere with the accelerator or the brake pedals.

Driver Controls

Position the floor mat so that the eyelet is over the pointed end of the retention post. Make sure that the mat does not interfere with the operation of the accelerator or the brake pedal. To remove the floor mat, reverse the installation procedure.

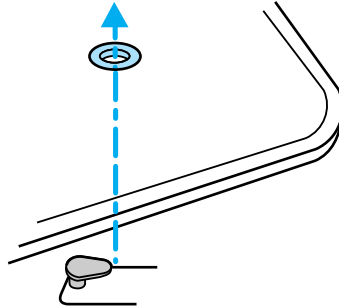

TAILGATE LOCK (IF EQUIPPED)

Your vehicle may be equipped with a tailgate lock designed to help prevent theft of the tailgate.

- Insert ignition key and turn to the right to engage lock.
- Turn ignition key to the left to unlock.

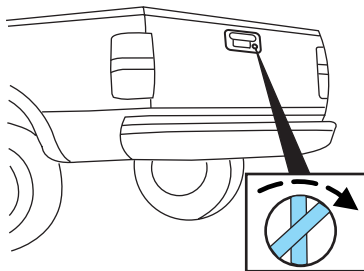

Tailgate removal

Your tailgate is removable to allow more room for loading.

1. Lower the tailgate.
2. Use a screwdriver to pry the spring clip (on each connector) past the head of the support screw. Disconnect cable.
3. Disconnect the other cable.
4. Lift tailgate to a 45-degree angle from horizontal.
5. Lift right side off of its hinge.
6. Lift tailgate to a 80-degree angle from horizontal.
7. Remove tailgate from left side hinge by sliding tailgate to the right. To install, follow the removal procedures in reverse order.

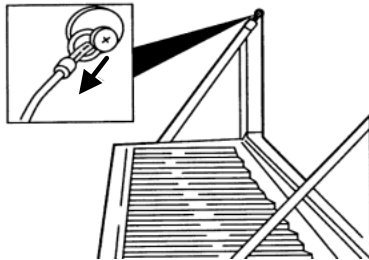

Driver Controls

BED EXTENDER (IF EQUIPPED)

Your vehicle may be equipped with a bed extender designed to extend the pickup box for larger loads.

To extend the bed extender :

1. Lower tailgate.
2. Pull the lever on each side of the bed extender to release it from the pickup box.
3. Lift the bed extender over on to the tailgate.

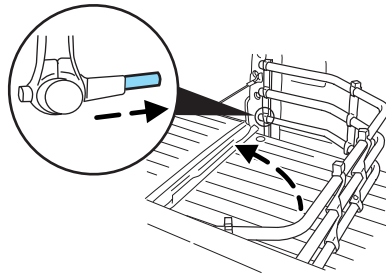

4. Evenly push down on the bed extender and push the lever in on each side locking it in place.

To stow the bed extender, follow steps one through four in reverse order.

The bed extender may be used to secure a load of up to 100 lb. (46 kg) on the tailgate.

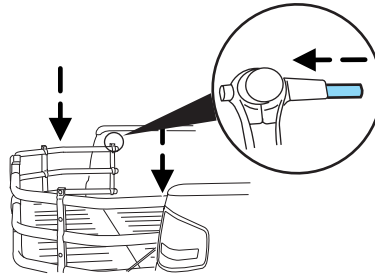

The bed extender should always be kept in the stowed position with the tailgate closed when not in use.

Activating bed extender Theft Deterrent Device:

The following procedure can be done with the bed extender in the stowed or extended position.

1. Locate the Phillips head screw in the middle of the vertical brace on the locking clip.
2. Turn the screw counterclockwise until you hear an audible click.
3. To deactivate, turn the screw clockwise until the locking clip moves freely.

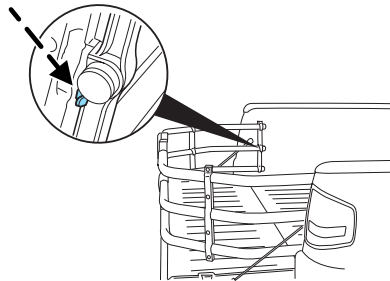

Driver Controls

To remove the bed extender:

1. Extend the bed extender.
2. Pull the lever on each side of the bed extender to unlock it.

Make sure the locking clip screws are loose before removing the bed extender.

3. Press the locking clips below the middle bar and lift the bed extender out of the channels on the “D” pillar.

To install the bed extender, follow the removal procedure in reverse order.

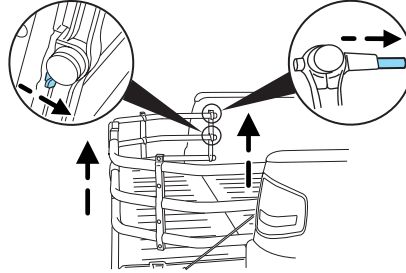

Locks and Security

KEYS

The key operates all locks on your vehicle. In case of loss, replacement keys are available from your dealer.

You should always carry a second key with you in a safe place in case you require it in an emergency.

Refer to the *SecuriLock[™] passive anti-theft system* section in this chapter for more information.

POWER DOOR LOCKS (IF EQUIPPED)

The power door lock controls are located on the driver and front passenger door panels.

Press control to unlock all vehicle doors.

Press control to lock all vehicle doors.

Smart unlocking feature

The smart unlocking feature helps prevent you from locking yourself out of your vehicle.

With the key in any ignition position:

- The driver's door will automatically unlock if it is locked by the driver's power lock control while the driver's door is open.

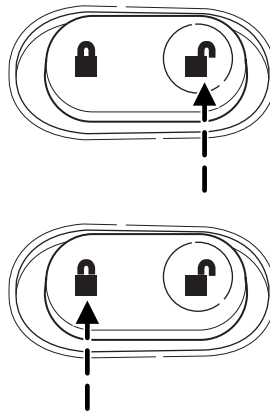

The vehicle may still be locked with the key in the ignition, and performing one of the following actions:

- Pressing the manual lock button on the door.
- Operating the remote entry transmitter.
- Operating the keyless entry keypad.
- Operating the driver's door with a key.

Autolock (if equipped)

The autolock feature is available on automatic transmission vehicles with power locking. This feature will lock all the doors when:

- all the doors are closed,

Locks and Security

- the ignition is in the 3 (ON) position,
- you shift into any gear putting the vehicle in motion, and
- the brake pedal is released and the vehicle attains a speed greater than 5 mph (8 km/h).

The autolock feature repeats when:

- any door is opened then closed while the ignition is in the 3 (ON) position, and
- the brake pedal is released and the vehicle attains a speed greater than 5 mph (8 km/h).

Deactivating/activating autolock





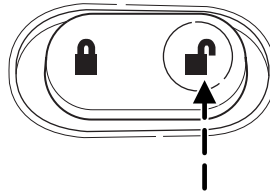

There are four methods to enable/disable this feature: One is through your authorized dealer, the second with a power door unlock/lock sequence, the third with the keypad, and the fourth using the message center (if equipped).

Before following the activation or deactivation procedures, unlock all doors using the power door lock/unlock control and ensure all vehicle doors are closed.

Power door unlock/lock procedure

You must complete Steps 1–5 within 30 seconds, or the procedure will have to be repeated. If the procedure needs to be repeated, you must wait a minimum of 30 seconds to begin again.



1. Turn the ignition to the 3 (ON) position, then press the  control three times.
2. Turn the ignition to the 1 (OFF/LOCK) position, then press the  control three times.
3. Turn the ignition to the 3 (ON) position; the horn will chirp to indicate the driver configuration mode has been activated.
4. Within five seconds, press  then the  control. **Note:** One horn chirp should be heard, indicating the system has been disabled. Conversely, a horn chirp followed by a honk will indicate the system is enabled. Pressing the  control then the  control will turn the feature ON if it was previously OFF, or OFF if it was previously ON. The

Locks and Security

horn will chirp once if autolock was deactivated or twice (one short chirp and one long honk) if autolock was activated.

5. Turn the ignition to the 1 (OFF/LOCK) position to exit programming.

Note: After exiting the driver configuration mode, the horn will chirp once to indicate a feature has been activated/deactivated.

Keyless entry key pad procedure

1. Turn the ignition to the 1 (OFF/LOCK) position.
2. Close all the doors.
3. Enter 5-digit entry code
4. Press and hold the 7 • 8. While holding the 7 • 8 press the 3 • 4.
5. Release the 3 • 4.
6. Release the 7 • 8.

The user should receive a **horn chirp** to indicate the system has been disabled or a chirp followed by a honk to indicate the system has been enabled.

Message center procedure

For information regarding the activation and deactivation of the autolocks feature using the message center, refer to *Message center (if equipped)* in the *Driver Controls* chapter.

CHILDPROOF DOOR LOCKS (ON VEHICLES WITH REAR DOORS)

- When these locks are set, the rear doors cannot be opened from the inside.
- The rear doors can be opened from the outside when the doors are unlocked.

The childproof locks are located on rear edge of each rear door and must be set separately for each door. Setting the lock for one door will not automatically set the lock for both doors.

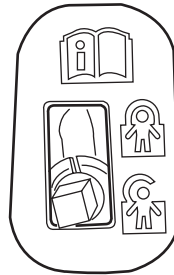

- Move lock control up to engage the childproof lock.
- Move control down to disengage childproof locks.

Locks and Security

REMOTE ENTRY SYSTEM (IF EQUIPPED)

This device complies with part 15 of the FCC rules and with RS-210 of Industry Canada. Operation is subject to the following two conditions: (1) This device may not cause harmful interference, and (2) This device must accept any interference received, including interference that may cause undesired operation.

Changes or modifications not expressly approved by the party responsible for compliance could void the user's authority to operate the equipment.

The typical operating range for your remote entry transmitter is approximately 33 feet (10 meters). A decrease in operating range could be caused by:

- weather conditions,
- nearby radio towers,
- structures around the vehicle, or
- other vehicles parked next to your vehicle.

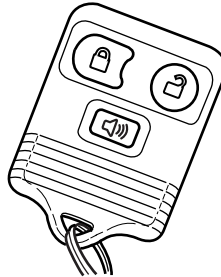

Your vehicle is equipped with a remote entry system which allows you to:

- unlock the vehicle doors without a key.
- lock all the vehicle doors without a key.
- activate the personal alarm.



If there are problems with the remote entry system, make sure to take **ALL remote entry transmitters** with you to your authorized dealer in order to aid in troubleshooting the problem.

Unlocking the doors

1. Press  and release to unlock the driver's door. **Note:** The interior lamps will illuminate.
2. Press  and release again within three seconds to unlock all the doors.

Locking the doors

1. Press  and release to lock all the doors. The parklamps will flash.

Locks and Security



2. Press  and release again within three seconds to confirm that all the doors are closed and locked. **Note:** The doors will lock again, the horn will chirp once, and the parklamps will flash once more.

If any of the doors are not properly closed the horn will make two quick chirps and the parklamps will not flash.

Power door lock/unlock disable feature (if equipped)

The  (lock) and  (unlock) features on your power door locks will not work from inside the vehicle when:



- the ignition has been turned to the 1 (OFF/LOCK) position, and
- 20 seconds elapse after all vehicle doors are closed and locked using the remote entry transmitter, the keyless entry pad, or the power door lock control (while the accompanying door is open).

The  (lock) and  (unlock) features will work again after:

- a door has become ajar,
- the ignition is turned to the 3 (ON) position, or
- using the UNLOCK  control on your remote entry transmitter or unlocking via the keyless entry keypad.

Deactivating/activating power door lock/unlock disable feature

All vehicle doors must be closed before beginning the procedure. You must complete Steps 1–5 within 30 seconds, or the procedure will have to be repeated. If the procedure needs to be repeated, you must wait a minimum of 30 seconds to begin again.

1. Turn the ignition to the 3 (ON) position, then press the  button three times.
2. Turn the ignition to the 1 (OFF/LOCK) position, then press the  button three times.
3. Turn the ignition to the 3 (ON) position; the horn will chirp to indicate the driver configuration mode has been activated.
4. Within five seconds, press the  control two times. **Note:** One horn chirp should be heard, indicating the system has been disabled.
5. Turn the ignition to the 1 (OFF/LOCK) position to exit programming. **Note:** After exiting the driver configuration mode, the horn will chirp once to indicate a feature has been activated/deactivated.

Sounding a panic alarm



Press  to activate the alarm. Press again or turn the ignition to 2 (ACCESSORY) or 3 (ON) to deactivate.

Locks and Security

Note: The panic alarm will only operate when the ignition is in the 1 (OFF/LOCK) position.

Memory feature (if equipped)

The remote entry system can also control the memory feature.

Press the  control once to unlock the driver's door. Pressing the  control will automatically move the seat and adjustable pedals to the desired memory position (the memory position corresponds to the transmitter being used).

Activating the memory feature

To activate this feature:

1. Position the seat and adjustable pedals to the positions you desire.
2. Press the SET control on the driver's seat.
3. Within 5 five seconds, press one control on the remote transmitter and then press the 1 or 2 control on the driver's door panel to which you would like to associate with Driver 1 or Driver 2 positions.
4. Repeat this procedure for another remote transmitter if desired.

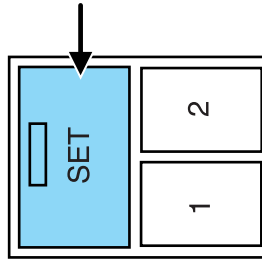

Deactivating the memory feature

To deactivate this feature:

1. Press the SET control on the driver's door seat.
2. Within 5 five seconds, press any control on the remote transmitter which you would like to deactivate and then press the SET control on the driver's door panel.
3. Repeat this procedure for another remote transmitter if desired.

Replacing the battery

The remote entry transmitter uses one coin type three-volt lithium battery CR2032 or equivalent.

Locks and Security

To replace the battery:

1. Twist a thin coin between the two halves of the remote entry transmitter near the key ring. **DO NOT TAKE THE RUBBER COVER AND CIRCUIT BOARD OFF THE FRONT HOUSING OF THE REMOTE ENTRY TRANSMITTER.**

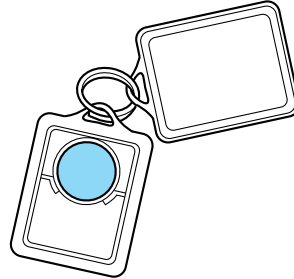

2. Do not wipe off any grease on the battery terminals on the back surface of the circuit board.

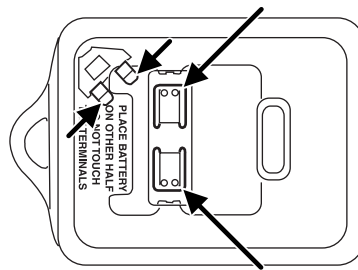

3. Remove the old battery. **Note:** Please refer to local regulations when disposing of transmitter batteries.

4. Insert the new battery. Refer to the diagram inside the remote entry transmitter for the correct orientation of the battery. Press the battery down to ensure that the battery is fully seated in the battery housing cavity.

5. Snap the two halves back together.

Note: Replacement of the battery will **not** cause the remote transmitter to become deprogrammed from your vehicle. The remote transmitter should operate normally after battery replacement.

Replacing lost transmitters

If a remote transmitter has been lost and you would like to remove it from the vehicle's memory, or you would like to purchase additional remote transmitters and have them programmed to your vehicle:

- Take **all** your vehicle's transmitters to your authorized dealer for programming, or
- Perform the programming procedure yourself.

Locks and Security

Programming remote transmitters

It is necessary to have **all** (maximum of six — original and/or new) of your remote transmitters available prior to beginning this procedure. If all remote entry transmitters are not present during the programming procedure, the transmitters that are not present during programming will no longer operate the vehicle.

To program the transmitters yourself:

Note: Ensure the brake pedal is not depressed during this sequence.

- Unlock all doors using the power door lock/unlock control. Insert a key and turn the ignition from the 1 (OFF/LOCK) to the 3 (ON) position and cycle between 1 (OFF/LOCK) and 3 (ON) eight times in rapid succession (within 10 seconds) with the eighth turn ending in the 3 (ON) position. The locks will cycle to confirm that the programming mode has been entered.
- Within 20 seconds, program a remote transmitter by pressing any button on a transmitter. The locks will cycle once to confirm that the remote transmitter has been programmed. (If more than 20 seconds pass before pressing a remote transmitter button, the programming mode will exit and the procedure will have to be repeated.)
- Repeat the previous step to program additional remote transmitters. The locks will cycle once to confirm that each remote transmitter has been programmed.
- When you have completed programming the remote transmitters, turn the ignition to the 1 (OFF/LOCK) position or wait 20 seconds. Again the doors will lock/unlock to confirm programming has been completed.

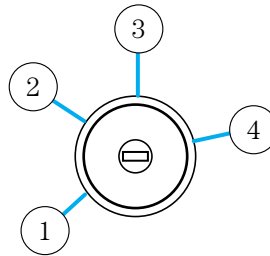

Illuminated entry

The interior lamps illuminate when the remote entry system is used to unlock the door(s) or sound the personal alarm, or when the factory set 5-digit code or your personal code are correctly entered into the keyless keypad.

The illuminated entry system will turn off the interior lights if:

- the ignition switch is turned to the 3 (ON) position, or

Locks and Security

- the remote transmitter lock control is pressed, or
- after 25 seconds of illumination.

The dome lamp control (if equipped) must **not** be set to the off position for the illuminated entry system to operate.

The inside lights will not turn off if:

- they have been turned on with the dimmer control, or
- any door is open.

The battery saver will shut off the interior lamps 30 minutes after the last door is closed, even if the dimmer control is on.

Perimeter lighting feature (if equipped)

The perimeter lighting feature illuminates the exterior of the vehicle in order to provide better visibility to the user while he or she approaches and enters the vehicle.

The perimeter lighting feature activates when:



- the ignition is in the 1 (OFF/LOCK) position,
- the autolamp sensor determines that it is dark, and
- the user activates an unlock feature, using either the remote keyless transmitter or the keypad.

The perimeter lighting feature will illuminate the headlamps and parking lamps for 25 seconds, or until:



- the ignition is turned to any position other than the 1 (OFF/LOCK) position, or
- the user activates a lock feature, using either the remote keyless transmitter or the keypad.

Enabling/disabling the perimeter lighting feature

Your vehicle comes with the perimeter lighting feature enabled. All vehicle doors must be closed before beginning the procedure. You must complete Steps 1–5 within 30 seconds, or the procedure will have to be repeated. If the procedure needs to be repeated, you must wait a minimum of 30 seconds to begin again.

1. Turn the ignition to the 3 (ON) position, then press the  control three times.
2. Turn the ignition to the 1 (OFF/LOCK) position, then press the  control three times.
3. Turn the ignition to the 3 (ON) position; the horn will chirp to indicate the driver configuration mode has been activated.

Locks and Security

4. Within five seconds, press the  control two times. **Note:** One horn chirp should be heard, indicating the system has been disabled. Conversely, a horn chirp followed by a honk will indicate the system is enabled. Pressing the power door  control two times again will turn the feature ON if it was previously OFF, or OFF if it was previously ON. Every two consecutive presses of the  control after successfully entering the configuration mode will change the enable/disable condition of the feature.

5. Turn the ignition to the 1 (OFF/LOCK) position to exit programming. **Note:** After exiting the driver configuration mode, the horn will chirp once to indicate a feature has been activated/deactivated.

KEYLESS ENTRY SYSTEM (IF EQUIPPED)

You can use the keyless entry keypad to:

- lock all vehicle doors.
- unlock only the driver's door.
- unlock all vehicle doors.
- program/erase the customer keycode.
- enable/disable the autolocking feature.



The keypad can be operated with the factory set 5-digit entry code; this code is located on the owner's wallet card in the glove box, is marked on the computer module, and is available from your authorized dealer. You can also create your own 5-digit personal entry code.

When pressing the controls on the keypad, press the middle of the controls to ensure a good activation.

Antiscan feature

The keyless entry keypad is equipped with an anti-theft function called "antiscan." The antiscan feature provides a one-minute lockout feature, where the user is unable to enter the vehicle using the keypad; this lockout occurs when a valid entry code has not been entered by the user within 7 attempts (35 consecutive button presses). During the lockout, the keypad will flash and pressing the controls on the keypad will be ignored, except for pressing the 7 • 8 and the 9 • 0 controls simultaneously, which will still lock the vehicle.

The antiscan feature will be turned off after:

- one minute, when the antiscan feature times out.

Locks and Security

- one minute of keypad inactivity.
- the  control is pressed on the remote entry transmitter.
- the ignition is turned from the 1 (OFF/LOCK) position to the 3 (ON) position, or from the 3 (ON) position to the 1 (OFF/LOCK) position.

Programming a personal entry code

To create your own personal entry code:

1. Enter the factory set code (keypad will illuminate when pressed).
2. Within five seconds press the 1 • 2 on the keypad.
3. Enter your personal 5-digit code. Each number must be entered within five seconds of each other.
4. After the code is entered, the locks will cycle, confirming that the new code has been set.

Tips:

- Do not set a code that uses five of the same number.
- Do not use five numbers in sequential order.
- The factory set code will work even if you have set your own personal code.
- If you set a second personal code it will erase your first personal code.

Erasing personal code

1. Enter the factory set 5-digit code.
2. Press and release 1 • 2 then,
3. Press and hold the 1 • 2 for two seconds. This must be done within five seconds of completing Step 1.

Your personal code is now erased and only the factory set 5-digit code will work.

Unlocking and locking the doors using keyless entry keypad

To unlock the driver's door, enter the factory set 5-digit code or your personal code. Each number must be pressed within five seconds of each other. **Note:** The driver's door will unlock and the interior lamps will illuminate after the factory set 5-digit code or your personal code are correctly entered.

To unlock all doors, press the 3 • 4 control within five seconds.

To lock all doors, press the 7 • 8 and the 9 • 0 at the same time. You **do not** need to enter the keypad code first. **Note:** The interior lamps will turn off.

Locks and Security

SECURILOCK™ PASSIVE ANTI-THEFT SYSTEM

SecuriLock™ passive anti-theft system is an engine immobilization system. This system is designed to help prevent the engine from being started unless a **coded key programmed to your vehicle** is used. The use of the wrong type of coded key may lead to a “no-start” condition.

Your vehicle comes with two coded keys; additional coded keys may be purchased from your authorized dealer. The authorized dealer can program your spare keys to your vehicle or you can program the keys yourself. Refer to *Programming spare keys* for instructions on how to program the coded key.

Note: The SecuriLock™ passive anti-theft system is not compatible with non-Ford aftermarket remote start systems. Use of these systems may result in vehicle starting problems and a loss of security protection.

Note: Large metallic objects, electronic devices that are used to purchase gasoline or similar items, or a second coded key on the same key chain may cause vehicle starting issues. You need to prevent these objects from touching the coded key while starting the engine. These objects will not cause damage to the coded key, but may cause a momentary issue if they are too close to the key when starting the engine. If a problem occurs, turn the ignition off, remove all objects on the key chain away from the coded key and restart the engine.

Anti-theft indicator

The anti-theft indicator is located on top of the instrument panel.

- When the ignition is in the 1 (OFF/LOCK) position, the indicator will flash once every 2 seconds to indicate the SecuriLock™ system is functioning as a theft deterrent.
- When the ignition is in the 3 (ON) position, the indicator will glow for 3 seconds to indicate normal system functionality.

If a problem occurs with the SecuriLock™ system, the indicator will flash rapidly or glow steadily when the ignition is in the 3 (ON) position. If this occurs, the vehicle should be taken to an authorized dealer for service.

Locks and Security

Automatic arming

The vehicle is armed immediately after switching the ignition to the 1 (OFF/LOCK) position.

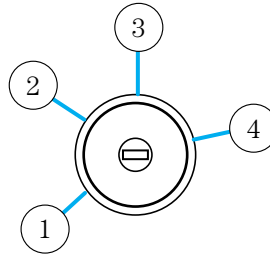

Automatic disarming

Switching the ignition to the 3 (ON) position with a **coded key** disarms the vehicle.

Replacement keys

If your keys are lost or stolen and you don't have an extra coded key, you will need to have your vehicle towed to an authorized dealer. The key codes need to be erased from your vehicle and new coded keys will need to be programmed.

Replacing coded keys can be very costly. Store an extra programmed key away from the vehicle in a safe place to help prevent any inconveniences. Please visit an authorized dealer to purchase additional spare or replacement keys.

Programming spare keys

A maximum of eight keys can be coded to your vehicle. Only SecuriLock[™] keys can be used. To program a **coded key** yourself, you will need two previously programmed **coded keys** (keys that already operate your vehicle's engine) and the new unprogrammed key(s) readily accessible for timely implementation of each step in the procedure.

If two previously programmed coded keys are not available, you must bring your vehicle to your authorized dealer to have the spare coded key(s) programmed.

Please read and understand the entire procedure before you begin.

Locks and Security

1. Insert the first previously programmed **coded key** into the ignition and turn the ignition from the 1 (OFF/LOCK) position to the 3 (ON) position (maintain ignition in the 3 (ON) position for at least one second, but no more than ten seconds).

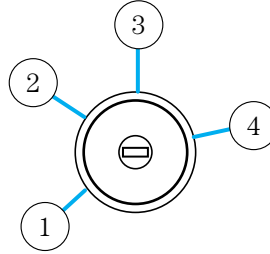

2. Turn ignition from the 3 (ON) position back to the 1 (OFF/LOCK) position in order to remove the first **coded key** from the ignition.

3. Within ten seconds of removing the first **coded key**, insert the second previously programmed **coded key** into the ignition and turn the ignition from the 1 (OFF/LOCK) position to the 3 (ON) position (maintain ignition in the 3 (ON) position for at least one second but no more than ten seconds).

4. Turn the ignition from the 3 (ON) position back to the 1 (OFF/LOCK) position in order to remove the second **coded key** from the ignition.

5. Within 10 seconds of removing the second **coded key**, insert the new unprogrammed key (new key/valet key) into the ignition and turn the ignition from the 1 (OFF/LOCK) position to the 3 (ON) position (maintain ignition in the 3 (ON) position for at least one second, but no more than ten seconds). This step will program your new key to a coded key.

6. To program additional new unprogrammed key(s), repeat Steps 1 through 5.

If successful, the new coded key(s) will start the vehicle's engine and the theft indicator will illuminate for three seconds and then go out.

If not successful, the new coded key(s) will not start the vehicle's engine and the theft indicator will flash on and off and you may repeat Steps 1 through 5. If failure repeats, bring your vehicle to your authorized dealer to have the new spare key(s) programmed.

Seating and Safety Restraints

SEATING

Notes:



Reclining the seatback can cause an occupant to slide under the seat's safety belt, resulting in severe personal injuries in the event of a collision.



Do not pile cargo higher than the seatbacks to reduce the risk of injury in a collision or sudden stop.



Before returning the seatback to its original position, make sure that cargo or any objects are not trapped behind the seatback. After returning the seatback to its original position, pull on the seatback to ensure that it has fully latched. An unlatched seat may become dangerous in the event of a sudden stop or collision.

Adjustable head restraints

Head restraints help to limit head motion in the event of a rear collision. Adjust your head restraint so that it is located directly or as close as possible behind your head.

The head restraints can be moved up and down.

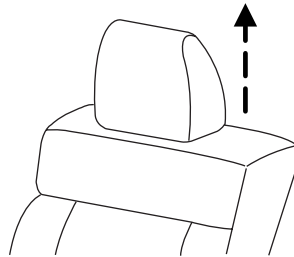

Seating and Safety Restraints

Push control to lower head restraint.

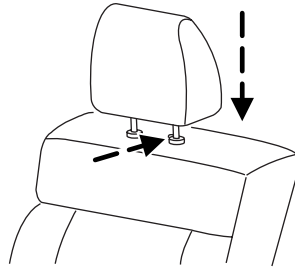

Front seat

- Lift the track release bar to move the seat forward or rearward. Make sure that the seat is related into place.
- Pull the release lever handle located on the side of the seat up to move the seatback forward or backward.

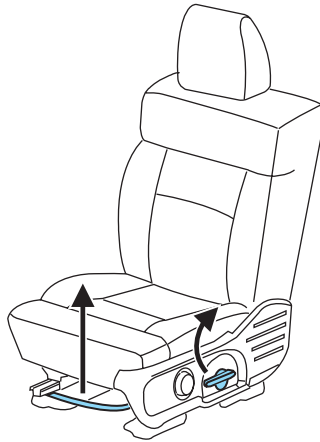

Seating and Safety Restraints

Using the armrest (if equipped)

Push the release control to move the armrest up or down.

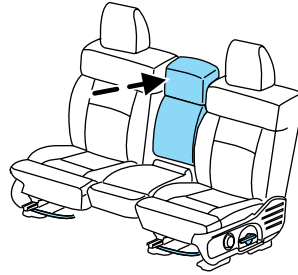

Using the manual lumbar support

For more lumbar support, turn the lumbar support control toward the front of vehicle.

For less lumbar support, turn the lumbar support control toward the rear of vehicle.

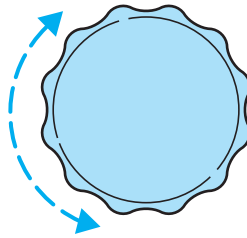

Adjusting the front power seat (if equipped)



Never adjust the driver's seat or seatback when the vehicle is moving.



Do not pile cargo higher than the seatbacks to avoid injuring people in a collision or sudden stop.





Always drive and ride with your seatback upright and the lap belt snug and low across the hips.



Reclining the seatback can cause an occupant to slide under the seat's safety belt, resulting in severe personal injuries in the event of a collision.

Seating and Safety Restraints

 Sitting improperly out of position or with the seat back reclined too far can take off weight from the seat cushion and affect the decision of the passenger sensing system, resulting in serious injury or death in a crash. Always sit upright against your seatback, with your feet on the floor.

 To reduce the risk of possible serious injury: Do not hang objects off seat back or stow objects in the seatback map pocket (if equipped) when a child is in the front passenger seat. Do not place objects underneath the front passenger seat or between the seat and the center console (if equipped). Check the “passenger airbag off” or “pass airbag off” indicator lamp for proper airbag status. Refer to *Front passenger sensing system* section for additional details. Failure to follow these instructions may interfere with the front passenger seat sensing system.

The control is located on the outboard side of the seat cushion.

Press the front or rear portion to tilt the seat.

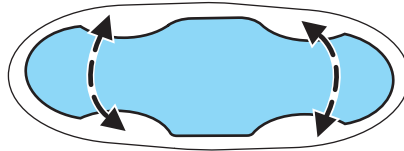

Press the control to move the seat forward, backward, up or down.

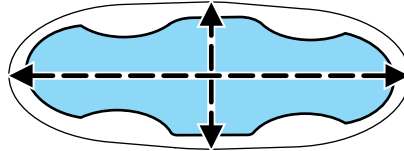

Seating and Safety Restraints

Memory seats/adjustable pedals (if equipped)

This system allows automatic positioning of the driver seat and adjustable pedals to two programmable positions.

The memory seat control is located on the driver's seat.

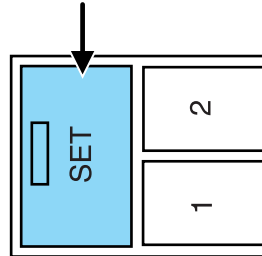

- To program position one, move the driver seat, and adjustable pedals to the desired position. Press the SET control. The SET control indicator light will briefly illuminate. While the light is illuminated, press control 1.
- To program position two, repeat the previous procedure using control 2.

A position can only be recalled when the transmission gearshift is in Park. A memory position may be programmed at any time.

Heated seats (if equipped)

To operate the heated seats, do the following:

- Push control located on the instrument panel to set at high heat.
- Push control again to set at low heat.
- Push again to deactivate.



The indicator light on the control will illuminate when activated.

The system automatically shuts off after 10 minutes.

REAR SEATS

Head restraints

The purpose of these head restraints is to help limit head motion in the event of a rear collision. To properly adjust your head restraints, lift the head restraint so that it is located directly behind your head or as close to that position as possible.

Seating and Safety Restraints

The head restraints can be moved up and down. Lift the head restraint so that it is located directly or as close as possible behind your head.

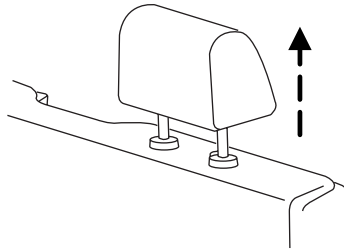

Push control to lower head restraint.

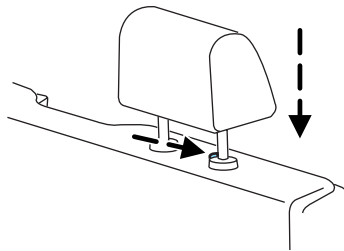

Folding up the rear seats (if equipped)

The rear seat has a split 60/40 cushion. Each seat cushion can be flipped up into the seatback position.

1. Pull control to release seat cushion.
2. Rotate seat cushion up until it locks into vertical storage position.

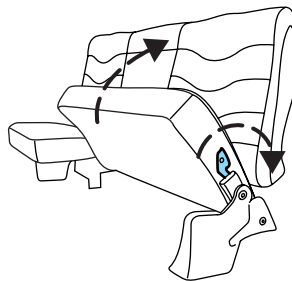

Seating and Safety Restraints

Returning the seat to seating position



Before returning the seatback to its original position, make sure that cargo or any objects are not trapped underneath the seatback. After returning the seatback to its original position, pull on the seatback to ensure that it has fully latched. An unlatched seat may become dangerous in the event of a sudden stop or collision.

1. Pull control on the side of the seat to release seat cushion from storage position.
2. Push seat cushion down until it locks into horizontal position.

SAFETY RESTRAINTS

Personal Safety System™

The Personal Safety System™ provides an improved overall level of frontal crash protection to front seat occupants and is designed to help further reduce the risk of airbag-related injuries. The system is able to analyze different occupant classifications and conditions and crash severity before activating the appropriate safety devices to help better protect a range of occupants in a variety of frontal crash situations.

Your vehicle's Personal Safety System™ consists of:

- Driver and passenger dual-stage airbag supplemental restraints.
- Front outboard safety belts with pretensioners, energy management retractors, and safety belt usage sensors.
- Driver's seat position sensor.
- Front crash severity sensor.
- Front passenger sensing system
- Passenger Airbag Off indicator light.
- Restraints Control Module (RCM) with impact and safing sensors.
- Restraint system warning light and back-up tone.
- The electrical wiring for the airbags, crash sensor(s), safety belt pretensioners, front safety belt usage sensors, driver seat position sensor, and indicator lights.

How does the Personal Safety System™ work?

The Personal Safety System™ can adapt the deployment strategy of your vehicle's safety devices according to crash severity and occupant

Seating and Safety Restraints

classification and conditions. A collection of crash and occupant sensors provides information to the Restraints Control Module (RCM). During a crash, the RCM activates the safety belt pretensioners and/or either none, one, or both stages of the dual-stage airbag supplemental restraints based on crash severity and occupant classification and conditions.

The fact that the pretensioners or airbags did not activate for both front seat occupants in a collision does not mean that something is wrong with the system. Rather, it means the Personal Safety System[™] determined the accident conditions (crash severity, belt usage, etc.) were not appropriate to activate these safety devices. Front airbags and pretensioners are designed to activate only in frontal and near-frontal collisions, not rollovers, side-impacts, or rear-impacts unless the collision causes sufficient longitudinal deceleration.

Driver and passenger dual-stage airbag supplemental restraints

The dual-stage airbags offer the capability to tailor the level of airbag inflation energy. A lower, less forceful energy level is provided for more common, moderate-severity impacts. A higher energy level is used for the most severe impacts. Refer to *Airbag Supplemental Restraints* section in this chapter.

Front crash severity sensor

The front crash severity sensor enhances the ability to detect the severity of an impact. Positioned up front, it provides valuable information early in the crash event on the severity of the impact. This allows your Personal Safety System[™] to distinguish between different levels of crash severity and modify the deployment strategy of the dual-stage airbags and safety belt pretensioners.

Driver's seat position sensor

The driver's seat position sensor allows your Personal Safety System[™] to tailor the deployment level of the driver dual-stage airbag based on seat position. The system is designed to help protect smaller drivers sitting close to the driver airbag by providing a lower airbag output level.

Front passenger sensing system

For airbags to do their job they must inflate with great force, and this force can pose a potentially deadly risk to occupants that are very close to the airbag when it begins to inflate. For some occupants, like infants in rear-facing child seats, this occurs because they are initially sitting very close to the airbag. For other occupants, this occurs when the occupant is not properly restrained by safety belts or child safety seats

Seating and Safety Restraints

and they move forward during pre-crash braking. The most effective way to reduce the risk of unnecessary injuries is to make sure all occupants are properly restrained. Accident statistics suggest that children are much safer when properly restrained in the rear seating positions than in the front.



Air bags can kill or injure a child in a child seat. **NEVER** place a rear-facing child seat in front of an active air bag. If you must use a forward-facing child seat in the front seat, move the seat all the way back.



Always transport children 12 years old and under in the back seat and always properly use appropriate child restraints.

The front passenger sensing system can automatically turn off the passenger front airbag when a rear facing child seat, a forward-facing child restraint, or a booster seat is detected. Even with this technology, parents are **STRONGLY** encouraged to always properly restrain children in the rear seat. The sensor also turns off the airbag when the passenger seat is empty to prevent unnecessary replacement of the airbag(s) after a collision.

When the front passenger seat is occupied and the sensing system has turned off the passenger's frontal airbag, the "pass airbag off" indicator will light and stay lit to remind you that the front passenger frontal airbag is off. See *Front passenger sensing system* in the *Airbag supplemental restraint system (SRS)* section of this chapter.

Front safety belt usage sensors

The front safety belt usage sensors detect whether or not the driver and front outboard passenger safety belts are fastened. This information allows your Personal Safety System[™] to tailor the airbag deployment and safety belt pretensioner activation depending upon safety belt usage. Refer to *Safety belt usage sensors* later in this chapter.

Front outboard safety belt pretensioners

The safety belt pretensioners at the front outboard seating positions are designed to tighten the safety belts firmly against the occupant's body during frontal collisions. This helps increase the effectiveness of the safety belts. In frontal collisions, the safety belt pretensioners can be activated alone or, if the collision is of sufficient severity, together with the front airbags.

Seating and Safety Restraints

Front outboard safety belt energy management retractors

The front outboard safety belt energy management retractors allow webbing to be pulled out of the retractor in a gradual and controlled manner in response to the occupant's forward momentum. This helps reduce the risk of force-related injuries to the occupant's chest by limiting the load on the occupant. Refer to *Energy management retractors* section in this chapter.

Determining if the Personal Safety System™ is operational

The Personal Safety System™ uses a warning light in the instrument cluster or a back-up tone to indicate the condition of the system. Refer to the *Warning lights and chimes* section in the *Instrument Cluster* chapter. Routine maintenance of the Personal Safety System™ is not required.

The Restraints Control Module (RCM) monitors its own internal circuits and the circuits for the airbag supplemental restraints, crash sensor(s), safety belt pretensioners, front safety belt buckle sensors, and the driver seat position sensor. In addition, the RCM also monitors the restraints warning light in the instrument cluster. A difficulty with the system is indicated by one or more of the following.

- The warning light will either flash or stay lit.
- The warning light will not illuminate immediately after ignition is turned on.
- A series of five beeps will be heard. The tone pattern will repeat periodically until the problem and warning light are repaired.

If any of these things happen, even intermittently, have the Personal Safety System™ serviced at an authorized dealer immediately. Unless serviced, the system may not function properly in the event of a collision.

Safety restraints precautions





Always drive and ride with your seatback upright and the lap belt snug and low across the hips.





To reduce the risk of injury, make sure children sit in the back seat where they can be properly restrained.

Seating and Safety Restraints

 Never let a passenger hold a child on his or her lap while the vehicle is moving. The passenger cannot protect the child from injury in a collision.

 All occupants of the vehicle, including the driver, should always properly wear their safety belts, even when an airbag supplemental restraint system (SRS) is provided.

 It is extremely dangerous to ride in a cargo area, inside or outside of a vehicle. In a collision, people riding in these areas are more likely to be seriously injured or killed. Do not allow people to ride in any area of your vehicle that is not equipped with seats and safety belts. Be sure everyone in your vehicle is in a seat and using a safety belt properly.

 In a rollover crash, an unbelted person is significantly more likely to die than a person wearing a safety belt.

 Each seating position in your vehicle has a specific safety belt assembly which is made up of one buckle and one tongue that are designed to be used as a pair. 1) Use the shoulder belt on the outside shoulder only. Never wear the shoulder belt under the arm. 2) Never swing the safety belt around your neck over the inside shoulder. 3) Never use a single belt for more than one person.

 Always transport children 12 years old and under in the back seat and always properly use appropriate child restraints.

 Safety belts and seats can become hot in a vehicle that has been closed up in sunny weather; they could burn a small child. Check seat covers and buckles before you place a child anywhere near them.

Seating and Safety Restraints

Combination lap and shoulder belts

1. Insert the belt tongue into the proper buckle (the buckle closest to the direction the tongue is coming from) until you hear a snap and feel it latch. Make sure the tongue is securely fastened in the buckle.

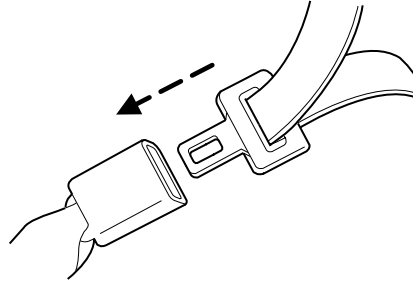

2. To unfasten, push the release button and remove the tongue from the buckle.

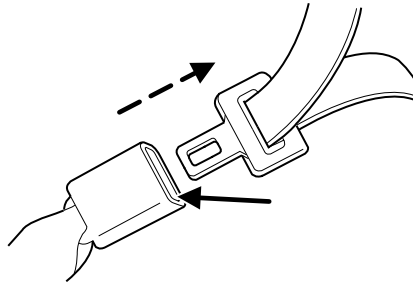

Center front safety belt (Regular Cab center seating position only)



Always use both lap and shoulder safety belt in the Regular Cab center seating position.

If you carry large cargo behind the seat or items that might damage or soil the belt, detach the belt from the seat:

1. Release the mini-buckle by inserting a key or safety belt tongue into the slot.

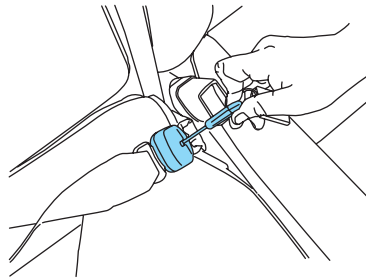

Seating and Safety Restraints

2. Insert the belt into the clip on the back panel. Protect the stowed belt if you carry cargo this may damage or soil the belt.

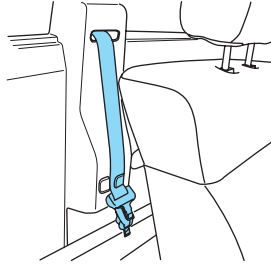

If the belt has been disconnected to carry large objects behind the seat, reconnect it as follows:

1. Remove the belt from the stowage clip on the back panel.

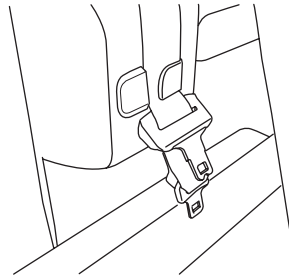

2. Buckle the small tongue on the end of the belt into the mini-buckle on the driver's side. The belt is now ready for use. This mini-buckle should stay buckled at all times unless cargo-carrying makes it necessary to detach the belt.

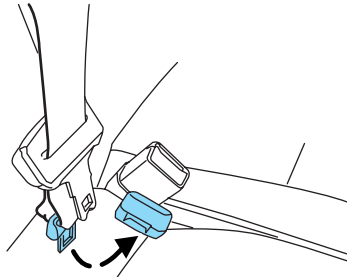

Safety belt with cinch tongue (Regular Cab center only)

The cinch tongue will slide up and down the belt webbing when the belt is stowed or while putting safety belts on. When the lap/shoulder safety belt is buckled, the cinch tongue will allow the lap portion to be

Seating and Safety Restraints

shortened, but pinches the webbing to keep the lap portion from getting longer. The cinch tongue is designed to slip during a crash, so always wear the shoulder belt properly and don't allow any slack in either the lap or shoulder portions.

Before you can reach and latch a combination lap and shoulder belt having a cinch tongue into the buckle, you may have to lengthen the lap belt portion of it.

1. To lengthen the lap belt, pull some webbing out of the shoulder belt retractor.
2. While holding the webbing below the tongue, grasp the tip (metal portion) of the tongue so that it is parallel to the webbing and slide the tongue upward.

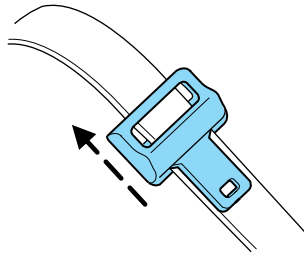

3. Provide enough lap belt length so that the tongue can reach the buckle.

How to fasten the cinch tongue (Regular Cab center only)

1. Pull the combination lap and shoulder belt from the retractor so that the shoulder belt portion of the safety belt crosses your shoulder and chest.
2. Be sure the belt is not twisted. If the belt is twisted, remove the twist.
3. Insert the belt tongue into the proper buckle for your seating position until you hear a snap and feel it latch.
4. Make sure the tongue is securely fastened to the buckle by pulling on the tongue.



The lap belt should fit snugly and as low as possible around the hips, not across the waist.



Front and rear seat occupants, including pregnant women, should wear safety belts for optimum protection in an accident.

Seating and Safety Restraints

 Each seating position in your vehicle has a specific safety belt assembly which is made up of one buckle and one tongue that are designed to be used as a pair. 1) Use the shoulder belt on the outside shoulder only. Never wear the shoulder belt under the arm. 2) Never swing the safety belt around your neck over the inside shoulder. 3) Never use a single belt for more than one person.

While you are fastened in the safety belt, the combination lap/shoulder belt with a cinch tongue adjusts to your movement. However, if you brake hard, turn hard, or if your vehicle receives an impact of 8 km/h (5 mph) or more, the safety belt will become locked and help reduce your forward movement.

Lap belts

Adjusting the lap belt (Center seat position SuperCab and SuperCrew only)

 The lap belt should fit snugly and as low as possible around the hips, not across the waist.

The front center lap belt tongue is designed to fit only in the correct buckle. The tongue will not securely latch if you attempt to use it in any of the outboard seating position buckles. To ensure that you have used the correct buckle you should hear a snap and feel it latch.

• **Front center lap belt**

The lap belt does not adjust automatically.

Insert the tongue into the correct buckle (the buckle closest to the direction the tongue is coming from). To lengthen the belt, turn the tongue at a right angle to the belt and pull across your lap until it reaches the buckle. To tighten the belt, pull the loose end of the belt through the tongue until it fits snugly across the hips.

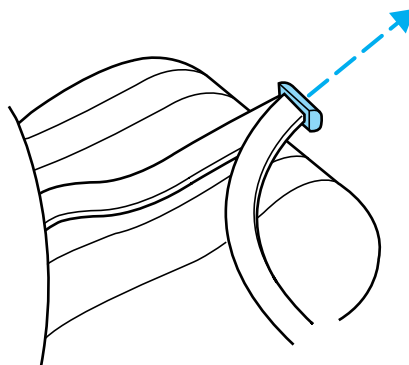

Seating and Safety Restraints

Shorten and fasten the belt when not in use.

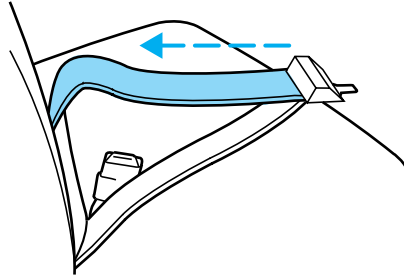

Energy management retractors

Your vehicle has a safety belt system equipped with energy management retractors at the driver and front outboard passenger seating positions.

An energy management retractor is a device which pays out webbing in a controlled manner. This feature is designed to help further reduce the risk of force-related injuries to the occupant.

Safety belt systems equipped with an energy management retractor must be replaced if they were in use during a frontal collision which resulted in deployment of the frontal airbags. Refer to the *Safety belt maintenance* section in this chapter.

The front and rear safety restraints in the vehicle are combination lap and shoulder belts. The front passenger outboard and rear outboard seat safety belts have two types of locking modes described below:

Vehicle sensitive mode

The vehicle sensitive mode is the normal retractor mode, allowing free shoulder belt length adjustment to your movements and locking in response to vehicle movement. For example, if the driver brakes suddenly or turns a corner sharply, or the vehicle receives an impact of approximately 5 mph (8 km/h) or more, the combination safety belts will lock to help reduce forward movement of the driver and passengers.

The front outboard safety belts can also be made to lock manually by quickly pulling on the shoulder belt. Rear safety belts (if equipped) can also be made to lock up by pulling quickly on the belt.

Automatic locking mode

In this mode, the shoulder belt is automatically pre-locked. The belt will still retract to remove any slack in the shoulder belt.

The automatic locking mode is not available on the driver safety belt, or the Regular Cab center safety belt.

Seating and Safety Restraints

When to use the automatic locking mode

- **Anytime** a child safety seat is installed in a front outboard passenger in a Regular Cab/ SuperCab/ SuperCrew or any rear seating position of a SuperCab or SuperCrew. The Regular Cab front center seatbelt has a cinch mechanism. Refer to *Safety belt with locking cinch tongue (Regular Cab center only)* earlier in this chapter. Children 12 years old and under should be properly restrained in a rear seat whenever possible. Refer to *Safety Restraints for Children* or *Safety Seats for Children* later in this chapter.

How to use the automatic locking mode

1. Buckle the combination lap and shoulder belt.

- Right front passenger seat

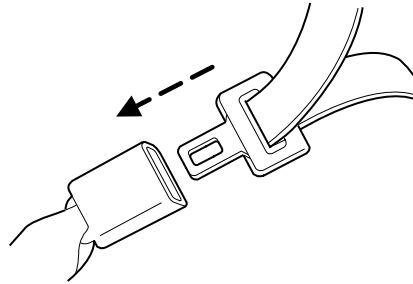

- Rear seats (if equipped)

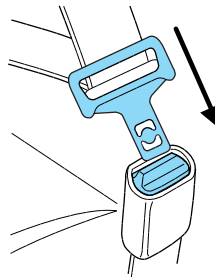

Seating and Safety Restraints

2. Grasp the shoulder portion and pull downward until the entire belt is extracted.



3. Allow the belt to retract. As the belt retracts, you will hear a clicking sound. This indicates the safety belt is now in the automatic locking mode.

How to disengage the automatic locking mode

Disconnect the combination lap/shoulder belt and allow it to retract completely to disengage the automatic locking mode and activate the vehicle sensitive (emergency) locking mode.

 After any vehicle collision, the safety belt systems at all outboard seating positions (except the driver position, which does not have this feature) must be checked by an authorized dealer to verify that the automatic locking retractor feature for child seats is still functioning properly. In addition, all safety belts should be checked for proper function.

 BELT AND RETRACTOR ASSEMBLY MUST BE REPLACED if the safety belt assembly “automatic locking retractor” feature or any other safety belt function is not operating properly when checked by an authorized dealer. Failure to replace the Belt and Retractor assembly could increase the risk of injury in collisions.

Safety belt pretensioner

Your vehicle is equipped with safety belt buckle pretensioners at the driver and front outboard passenger seating positions.

 Do NOT place objects between the seats, as this could interfere with the functioning of the pretensioner.

Seating and Safety Restraints

The driver and front outboard passenger safety belt pretensioners are designed to activate only during certain frontal or near-frontal collisions with sufficient longitudinal deceleration. A safety belt buckle pretensioner is a device which tightens the webbing of the lap and shoulder belts during some collisions in such a way that they fit more snugly against the body.

The driver and front outboard passenger safety belt system (including retractors, buckles and height adjusters) must be replaced if the vehicle is involved in a collision that results in the activation of the safety belt pretensioners. Refer to the *Safety belt maintenance* section in this chapter.



Failure to replace the safety belt assembly under the above conditions could result in severe personal injuries in the event of a collision.

Safety belt usage sensors

The driver and front outboard passenger safety belt buckles are equipped with sensors that detect if the safety belts are fastened. The sensors provide information to the Personal Safety System which can then adapt the airbag deployment or safety belt pretensioner activation based upon safety belt usage.



The Personal Safety System provides the most benefit to belted occupants. The system monitors and tailors the air bag deployment based upon safety belt usage. Failure to properly wear your safety belt will increase your risk of injury.

Seating and Safety Restraints

Front safety belt height adjustment (if equipped)

Your vehicle has safety belt height adjustments for the driver and right front passenger. Adjust the height of the shoulder belt so the belt rests across the middle of your shoulder.

To lower the shoulder belt height, push the button and slide the height adjuster down. To raise the height of the shoulder belt, push the button and slide the height adjuster up. Pull down on the height adjuster to make sure it is locked in place.

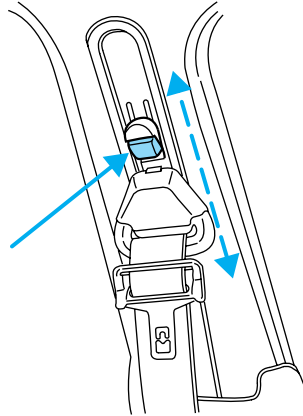

 Position the safety belt height adjusters so that the belt rests across the middle of your shoulder. Failure to adjust the safety belt properly could reduce the effectiveness of the seat belt and increase the risk of injury in a collision.

Safety belt warning light and indicator chime

The safety belt warning light illuminates in the instrument cluster and a chime sounds to remind the occupants to fasten their safety belts.

Seating and Safety Restraints

Conditions of operation

If...	Then...
The driver's safety belt is not buckled before the ignition switch is turned to the ON position...	The safety belt warning light illuminates 1-2 minutes and the warning chime sounds 4-8 seconds.
The driver's safety belt is buckled while the indicator light is illuminated and the warning chime is sounding...	The safety belt warning light and warning chime turn off.
The driver's safety belt is buckled before the ignition switch is turned to the ON position...	The safety belt warning light and indicator chime remain off.

BeltMinder®

The BeltMinder® feature is a supplemental warning to the safety belt warning function. This feature provides additional reminders by intermittently sounding a chime and illuminating the safety belt warning lamp in the instrument cluster when the driver's and front passenger's safety belt is unbuckled.

The BeltMinder® feature uses information from the front passenger sensing system to determine if a front seat passenger is present and therefore potentially in need of a warning. To avoid activating the BeltMinder® feature for objects placed in the front passenger seat, warnings will only be given to large front seat occupants as determined by the front passenger sensing system.

Both the driver's and passenger's safety belt usages are monitored and either may activate the BeltMinder® feature. The warnings are the same for the driver and the front passenger. If the BeltMinder® warnings have expired (warnings for approximately 5 minutes) for one occupant (driver or front passenger), the other occupant can still activate the BeltMinder® feature.

When the BeltMinder® feature is activated, the safety belt warning light illuminates and the warning chime sounds for 6 seconds every 30 seconds, repeating for approximately 5 minutes or until the safety belts are buckled.

Seating and Safety Restraints

The BeltMinder® feature uses two different warning chimes. During the first minute of activation, the warning chime will sound once every second. The remaining warning chimes will sound twice every second while the system is activated.

If...	Then...
The driver's and front passenger's safety belts are buckled...	The BeltMinder® feature will not activate.
The driver's or front passenger's safety belt is not buckled when the vehicle has reached at least 6 mph and 1-2 minutes have elapsed since the ignition switch has been turned to ON...	The BeltMinder® feature is activated - the safety belt warning light illuminates and the warning chime sounds for 6 seconds every 30 seconds, repeating for approximately 5 minutes or until the safety belts are buckled.
The driver's or front passenger's safety belt becomes unbuckled for approximately 1 minute while the vehicle is traveling at least 6 mph and 1-2 minutes have elapsed since the ignition switch has been turned to ON...	The BeltMinder® feature is activated - the safety belt warning light illuminates and the warning chime sounds for 6 seconds every 30 seconds, repeating for approximately 5 minutes or until the safety belts are buckled.
The BeltMinder® feature is activated and the vehicle speed is less than 3 mph...	The BeltMinder® feature is suspended - the safety belt warning light remains illuminated, but the warning chime does not sound. This time does not count towards the 5-minute expiration time.

Seating and Safety Restraints

The following are reasons most often given for not wearing safety belts:
(All statistics based on U.S. data)

Reasons given...	Consider..
“Crashes are rare events”	36700 crashes occur every day. The more we drive, the more we are exposed to “rare” events, even for good drivers. <i>1 in 4 of us will be seriously injured in a crash during our lifetime.</i>
“I’m not going far”	3 of 4 fatal crashes occur within 25 miles of home.
“Belts are uncomfortable”	We design our safety belts to enhance comfort. If you are uncomfortable - try different positions for the safety belt upper anchorage and seatback which should be as upright as possible; this can improve comfort.
“I was in a hurry”	Prime time for an accident. BeltMinder® reminds us to take a few seconds to buckle up.
“Safety belts don’t work”	Safety belts , when used properly, reduce risk of death to front seat occupants by 45% in cars , and by 60% in light trucks .
“Traffic is light”	Nearly 1 of 2 deaths occur in single-vehicle crashes , many when no other vehicles are around.
“Belts wrinkle my clothes”	Possibly, but a serious crash can do much more than wrinkle your clothes, particularly if you are unbelted.
“The people I’m with don’t wear belts”	Set the example, teen deaths occur 4 times more often in vehicles with TWO or MORE people. Children and younger brothers/sisters imitate behavior they see.
“I have an airbag”	Airbags offer greater protection when used with safety belts. Frontal airbags are not designed to inflate in rear and side crashes or rollovers.
“I’d rather be thrown clear”	Not a good idea. People who are ejected are 40 times more likely to DIE . Safety belts help prevent ejection, WE CAN’T “PICK OUR CRASH”.

Seating and Safety Restraints



Do not sit on top of a buckled safety belt or insert a latchplate into the buckle to avoid the BeltMinder® chime. To do so may adversely affect the performance of the vehicle's air bag system.

One time disable

If at any time the driver/front passenger quickly buckles then unbuckles the BeltMinder® feature for that seating position, the BeltMinder™ is disabled for the current ignition cycle. The BeltMinder® feature will re-enable during the same ignition cycle if the occupant buckles and remains buckled for approximately 30 seconds. Confirmation is not given for the one time disable.

Deactivating/activating the BeltMinder® feature

The driver and front passenger BeltMinder® are deactivated/activated independently. When deactivating/activating one seating position, do not buckle the other position as this will terminate the process.

Read Steps 1 - 4 thoroughly before proceeding with the deactivation/activation programming procedure.

The driver and front passenger BeltMinder® features can be deactivated/activated by performing the following procedure:

Before following the procedure, make sure that:

- The parking brake is set
- The gearshift is in P (Park) (automatic transmission)
- The ignition switch is in the OFF position
- The driver and front passenger safety belts are unbuckled



While the design allows you to deactivate your BeltMinder®, this system is designed to improve your chances of being safely belted and surviving an accident. We recommend you leave the BeltMinder® system activated for yourself and others who may use the vehicle. To reduce the risk of injury, do not deactivate/activate the BeltMinder® feature while driving the vehicle.

1. Turn the ignition switch to the RUN (or ON) position. (DO NOT START THE ENGINE)
2. Wait until the safety belt warning light turns off. (Approximately 1 minute)

138

Seating and Safety Restraints

- Step 3 must be completed within 50 seconds after the safety belt warning light turns off.
3. For the seating position being disabled, buckle then unbuckle the safety belt 9 times, ending in the unbuckled state. (Step 3 must be completed within 50 seconds after the safety belt warning light turns off.)
- After Step 3, the restraint system warning light (airbag light) will be turned on for three seconds.
4. Within 10 seconds of the light turning on, buckle then unbuckle the safety belt.
- This will disable the BeltMinder® feature for that seating position if it is currently enabled. As confirmation, the restraint system warning light will flash 4 times per second for 3 seconds.
 - This will enable the BeltMinder® feature for that seating position if it is currently disabled. As confirmation, the restraint system warning light will flash 4 times per second for 3 seconds, followed by 3 seconds with the light off, then followed by the restraint system warning light flashing 4 times per second for 3 seconds again.

Safety belt extension assembly

If the safety belt is too short when fully extended, there is a 8 inch (20 cm) safety belt extension assembly that can be added (part number 611C22). This assembly can be obtained from an authorized dealer.

Use only extensions manufactured by the same supplier as the safety belt. Manufacturer identification is located at the end of the webbing on the label. Also, use the safety belt extension only if the safety belt is too short for you when fully extended.



Do not use extensions to change the fit of the shoulder belt across the torso.

Safety belt maintenance

Inspect the safety belt systems periodically to make sure they work properly and are not damaged. Inspect the safety belts to make sure there are no nicks, tears or cuts. Replace if necessary. All safety belt assemblies, including retractors, buckles, front safety belt buckle assemblies, buckle support assemblies (slide bar-if equipped), shoulder belt height adjusters (if equipped), shoulder belt guide on seatback (if equipped), child safety seat LATCH and tether anchors, and attaching

Seating and Safety Restraints

hardware, should be inspected after a collision. Ford Motor Company recommends that all safety belt assemblies in use in vehicles involved in a collision be replaced. However, if the collision was minor and an authorized dealer finds that the belts do not show damage and continue to operate properly, they do not need to be replaced. Safety belt assemblies not in use during a collision should also be inspected and replaced if either damage or improper operation is noted.

 Failure to inspect and if necessary replace the safety belt assembly under the above conditions could result in severe personal injuries in the event of a collision.

For proper care of soiled safety belts, refer to *Interior* in the *Cleaning* chapter.

AIRBAG SUPPLEMENTAL RESTRAINT SYSTEM (SRS)

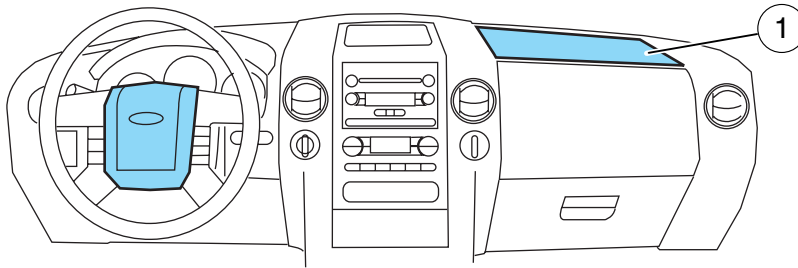

1. Airbag cover

The airbag supplemental restraint system is designed to work in conjunction with the safety belts to help protect the driver and front outboard passenger from certain upper body injuries. The term “supplemental restraint” means the airbags are intended as a supplement to the safety belts. Airbags alone cannot protect as well as airbags plus safety belts in impacts for which the airbags are designed to deploy, and airbags do not offer any protection in crashes for which they do not deploy.

The airbag supplemental restraint system consists of:

- driver and passenger dual stage airbag modules (which include the inflators and airbags).
- one or more impact and safing sensors.
- the same indicator light, RCM (restraints control module) and diagnostic unit used for the Personal safety system.

Seating and Safety Restraints

- Front passenger sensing system
- Passenger airbag off indicator light.

The airbag supplemental restraints are an integral part of the Personal Safety System. They are designed to be deployed in cases where the Personal Safety System has determined the occupant conditions and crash severity are appropriate to activate these devices. Refer to the *Personal Safety System* section in this chapter.

Important SRS precautions

 All occupants of the vehicle, including the driver, should always properly wear their safety belts, even when an airbag (SRS) is provided.

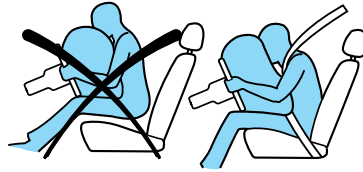

 Always transport children 12 years old and under in the back seat if your vehicle has a back seat. Rear facing infant seats should NEVER be placed in the front seats. This is because the back of the infant seat is too close to the inflating airbag and the risk of a fatal injury to the infant when the airbag inflates is substantial.

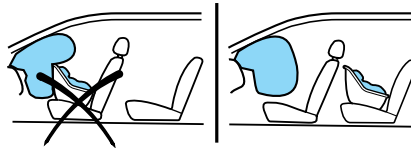

 The National Highway Traffic Safety Administration (NHTSA) recommends a minimum distance of at least 10 inches (25 cm) between an occupant's chest and the driver airbag cover.

 Never place your arms or feet over the airbag module as a deploying airbag can result in serious fractures or other injuries.

To properly position yourself away from the airbag:

- Move your seat to the rear as far as you can while still reaching the pedals comfortably.

Seating and Safety Restraints

- Recline the seat slightly one or two degrees from the upright position.

 Do not put anything on or over the airbag cover (1). Placing objects on or over the airbag cover may cause those objects to be thrown by the airbag into your face and torso or may result in a failure of the airbag to inflate properly, both of which could result in serious injury.

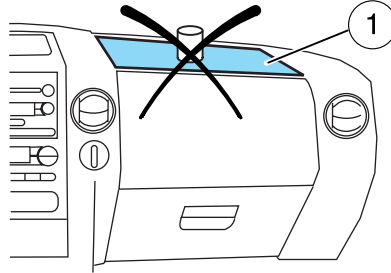

 Do not attempt to service, repair, or modify the airbag supplemental restraint systems or its fuses. See your authorized dealer.

 The front passenger airbag is not designed to offer protection to an occupant in the center front seating position.

 Modifying or adding equipment to the front end of the vehicle (including frame, bumper, front end body structure and tow hooks) may affect the performance of the airbag system, increasing the risk of injury. Do not modify the front end of the vehicle.

 Additional equipment may affect the performance of the airbag sensors increasing the risk of injury. Please refer to the *Body Builders Layout Book* for instructions about the appropriate installation of additional equipment.

Seating and Safety Restraints

Children and airbags

For additional important safety information, read all information on safety restraints in this guide.

Children must always be properly restrained. Accident statistics suggest that children are safer when properly restrained in the rear seat than in the front seat. Failure to follow these instructions may increase the risk of injury in a collision.

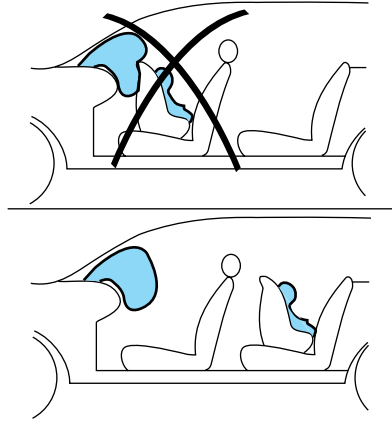

Airbags can kill or injure a child in a child seat.

NEVER place a rear-facing child seat in front of an active airbag. If you must use a forward-facing child seat in the front seat, move the seat all the way back.

If two adults and a child occupy a **Regular Cab**, properly restrain the child in the center front unless doing so would interfere with driving the vehicle. This arrangement provides lap and shoulder belt protection for all occupants, and airbag protection for the adults. A child or infant properly restrained in the center front seat should not incur risk of serious injury from the airbags.

Seating and Safety Restraints

How does the airbag supplemental restraint system work?

The airbag SRS is designed to activate when the vehicle sustains sufficient longitudinal deceleration.

The fact that the airbags did not inflate in a collision does not mean that something is wrong with the system. Rather, it means the forces were not of the type sufficient to cause activation. Airbags are designed to inflate in frontal and near-frontal collisions, not rollover, side-impact, or rear-impacts.

The airbags inflate and deflate rapidly upon activation. After airbag deployment, it is normal to notice a smoke-like, powdery residue or smell the burnt propellant. This may consist of cornstarch, talcum powder (to lubricate the bag) or sodium compounds (e.g., baking soda) that result from the combustion process that inflates the airbag. Small amounts of sodium hydroxide may be present which may irritate the skin and eyes, but none of the residue is toxic.

While the system is designed to help reduce serious injuries, it may also cause minor abrasions, swelling or temporary hearing loss. Because airbags must inflate rapidly and with considerable force, there is the risk of death or serious injuries such as fractures, facial and eye injuries or internal injuries, particularly to occupants who are not properly restrained or are otherwise out of position at the time of airbag deployment. Thus, it is extremely important that occupants be properly restrained as far away from the airbag cover as possible while maintaining vehicle control.

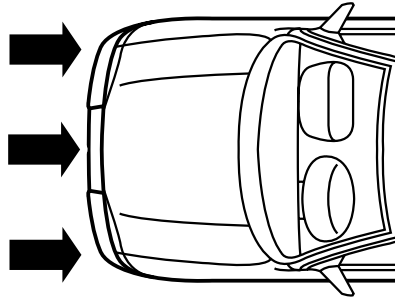

Several airbag system components get hot after inflation. Do not touch them after inflation.

Seating and Safety Restraints



If the airbag has deployed, **the airbag will not function again and must be replaced immediately.** If the airbag is not replaced, the unrepaired area will increase the risk of injury in a collision.

Determining if the system is operational

The SRS uses readiness lights in the instrument cluster or a tone to indicate the condition of the system. Refer to *Airbag readiness* in the *Instrument Cluster* chapter. Routine maintenance of the airbag is not required.

A difficulty with the system is indicated by one or more of the following:

- The readiness lights will either flash or stay lit.
- The readiness lights will not illuminate immediately after ignition is turned on.
- A series of five beeps will be heard. The tone pattern will repeat periodically until the problem and/or light are repaired.



If any of these things happen, even intermittently, have the SRS serviced at an authorized dealer immediately. Unless serviced, the system may not function properly in the event of a collision.

Disposal of airbags and airbag equipped vehicles (including pretensioners)

See your authorized dealer. Airbags **MUST BE** disposed of by qualified personnel.

Front passenger sensing system

The front passenger sensing system is designed to meet the regulatory requirements of Federal Motor Vehicle Safety Standard (FMVSS) 208 and is designed to disable (will not inflate) the front passenger's frontal airbag under certain conditions.

The front passenger sensing system works with sensors that are part of the front passenger's seat and safety belt. The sensors are designed to detect the presence of a properly seated occupant and determine if the front passenger's frontal airbag should be enabled (may inflate) or disabled (will not inflate).

Seating and Safety Restraints

The front passenger sensing system will disable (will not inflate) the front passenger's frontal airbag if:

- the front passenger seat is unoccupied, or has small/medium objects in the front seat,
- the system determines that an infant is present in a rear-facing infant seat that is installed according to the manufacturer's instructions,
- the system determines that a small child is present in a forward-facing child restraint that is installed according to the manufacturer's instructions,
- the system determines that a small child is present in a booster seat,
- a front passenger takes his/her weight off of the seat for a period of time,
- a child or a small person occupies the front passenger seat.

The front passenger sensing system uses a "passenger airbag off" or "pass airbag off" indicator which will illuminate and stay lit to remind you

PASSENGER AIRBAG OFF

that the front passenger frontal airbag is disabled. The indicator lamp is located in the center stack of the instrument panel just above the radio.

Note: The indicator lamp will illuminate for a short period of time when the ignition is turned to the ON position to confirm it is functional.

When the front passenger seat is not occupied (empty seat) or in the event that the front passenger frontal airbag is enabled (may inflate), the indicator lamp will be unlit.

The front passenger sensing system is designed to disable (will not inflate) the front passenger's frontal airbag when a rear facing infant seat, a forward-facing child restraint, or a booster seat is detected.

- When the front passenger sensing system disables (will not inflate) the front passenger frontal airbag, the indicator lamp will illuminate and stay lit to remind you that the front passenger frontal airbag is disabled.
- If the child restraint has been installed and the indicator lamp is not lit, then turn the vehicle off, remove the child restraint from the vehicle and reinstall the restraint following the child restraint manufacturer's instructions.

The front passenger sensing system is designed to enable (may inflate) the front passenger's frontal airbag anytime the system senses that a person of adult size is sitting properly in the front passenger seat.

Seating and Safety Restraints

- When the front passenger sensing system enables the front passenger frontal airbag (may inflate), the indicator will be unlit and stay unlit. If a person of adult size is sitting in the front passenger's seat, but the "passenger airbag off" or "pass airbag off" indicator lamp is lit, it is possible that the person isn't sitting properly in the seat. If this happens:
 - Turn the vehicle off and ask the person to place the seatback in the full upright position.
 - Have the person sit upright in the seat, centered on the seat cushion, with the person's legs comfortably extended.
 - Restart the vehicle and have the person remain in this position for about two minutes. This will allow the system to detect that person and enable the passenger's frontal airbag.
 - If the indicator lamp remains lit even after this, the person should be advised to ride in the rear seat.

Occupant	Pass Airbag Off Indicator Lamp	Passenger Airbag
Empty seat	Unlit	Disabled
Small child in child safety seat or booster	Lit	Disabled
Small child with safety belt buckled or unbuckled	Lit	Disabled
Adult	Unlit	Enabled



Even with Advanced Restraints Systems, children 12 and under should be properly restrained in the back seat.

After all occupants have adjusted their seats and put on safety belts, it's very important that they continue to sit properly. A properly seated occupant sits upright, leaning against the seat back, and centered on the seat cushion, with their feet comfortably extended on the floor. Sitting improperly can increase the chance of injury in a crash event. For example, if an occupant slouches, lies down, turns sideways, sits forward, leans forward or sideways, or puts one or both feet up, the chance of injury during a crash is greatly increased.



Sitting improperly out of position or with the seat back reclined too far can take off weight from the seat cushion and affect the decision of the front passenger sensing system, resulting in serious injury or death in a crash. Always sit upright against your seatback, with your feet on the floor.

Seating and Safety Restraints

The front passenger sensing system may detect small or medium objects placed on the seat cushion. For most objects that are in the front passenger seat, the passenger airbag will be disabled. Even though the passenger airbag is disabled, the "pass airbag off" lamp may or may not be illuminated according to the table below.

Objects	Pass Airbag Off Indicator Lamp	Passenger Airbag
Small (i.e. 3 ring binder, small purse, bottled water)	Unlit	Disabled
Medium (i.e. heavy briefcase, fully packed luggage)	Lit	Disabled
Empty seat, or small to medium object with safety belt buckled	Lit	Disabled

In case there is a problem with the front passenger sensing system, the airbag readiness lamp in the instrument cluster will stay lit.



DO NOT attempt to repair or service the system; take your vehicle immediately to an authorized dealer.



The front passenger airbag is not designed to offer protection to an occupant in the center seating position.



An out of position front center occupant could affect the decision of the front passenger sensing system.

If it is necessary to modify an advanced front airbag system to accommodate a person with disabilities, contact the Ford Customer Relationship Center at the phone number shown in the *Customer Assistance* section of this *Owner's Guide*.



Any alteration/modification to the front passenger seat may affect the performance of the front passenger sensing system.

Seating and Safety Restraints

SAFETY RESTRAINTS FOR CHILDREN

See the following sections for directions on how to properly use safety restraints for children. Also see *Airbag supplemental restraint system (SRS)* in this chapter for special instructions about using airbags.

Important child restraint precautions

You are required by law to use safety restraints for children in the U.S. and Canada. If small children (generally children who are four years old or younger and who weigh 40 lb. [18 kg] or less) ride in your vehicle, you must put them in safety seats made especially for children. Many states require that children use approved booster seats until they are eight years old. Check your local and state or provincial laws for specific requirements regarding the safety of children in your vehicle. When possible, always place children under age 12 in the rear seat of your vehicle. Accident statistics suggest that children are safer when properly restrained in the rear seating positions than in the front seating position.



Never let a passenger hold a child on his or her lap while the vehicle is moving. The passenger cannot protect the child from injury in a collision.

Always follow the instructions and warnings that come with any infant or child restraint you might use.

Children and safety belts

If the child is the proper size, restrain the child in a safety seat. Children who are too large for child safety seats (as specified by your child safety seat manufacturer) should always wear safety belts.

Follow all the important safety restraint and airbag precautions that apply to adult passengers in your vehicle.

If the shoulder belt portion of a combination lap and shoulder belt can be positioned so it does not cross or rest in front of the child's face or neck, the child should wear the lap and shoulder belt. Moving the child closer to the center of the vehicle may help provide a good shoulder belt fit.



Do not leave children, unreliable adults, or pets unattended in your vehicle.

Seating and Safety Restraints

Child booster seats

Children outgrow a typical convertible or toddler seat when they weigh 40 lb. (18 kg) and are around 4 years of age. Although the lap/shoulder belt will provide some protection, these children are still too small for lap/shoulder belts to fit properly, which could increase the risk of serious injury in a crash.

To improve the fit of both the lap and shoulder belt on children who have outgrown child safety seats, Ford Motor Company recommends use of a belt-positioning booster.

Booster seats position a child so that safety belts fit better. They lift the child up so that the lap belt rests low across the hips and the knees bend comfortably. Booster seats may also make the shoulder belt fit better and more comfortably. Try to keep the belt near the middle of the shoulder.

When children should use booster seats

Children need to use booster seats from the time they outgrow the toddler seat until they are big enough for the vehicle seat and lap/shoulder belt to fit properly. Generally this is when they weigh about 80 lb. (36 kg) (about 8 to 12 years old).

Booster seats should be used until you can answer YES to ALL of these questions:

- Can the child sit all the way back against the vehicle seat back with knees bent comfortably at the edge of the seat without slouching?

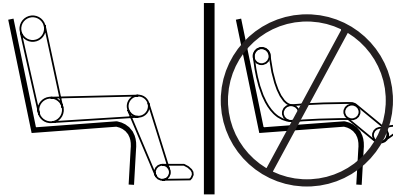

- Does the lap belt rest low across the hips?
- Is the shoulder belt centered on the shoulder and chest?
- Can the child stay seated like this for the whole trip?

Seating and Safety Restraints

Types of booster seats

There are two types of belt-positioning booster seats:

- Those that are backless.

If your backless booster seat has a removable shield, remove the shield and use the lap/shoulder belt. If a seating position has a low seat back and no head restraint, a backless booster seat may place your child's head (top of ear level) above the top of the seat. In this case, move the backless booster to another seating position with a higher seat back and lap/shoulder belts.



- Those with a high back.

If, with a backless booster seat, you cannot find a seating position that adequately supports your child's head, a high back booster seat would be a better choice.



Either type can be used at any seating position equipped with lap/shoulder belts if your child is over 40 lb. (18 kg).

Seating and Safety Restraints

Children and booster seats vary widely in size and shape. Choose a booster that keeps the lap belt low and snug across the hips, never up across the stomach, and lets you adjust the shoulder belt to cross the chest and rest snugly near the center of the shoulder. The drawings below compare the ideal fit (center) to a shoulder belt uncomfortably close to the neck and a shoulder belt that could slip off the shoulder.

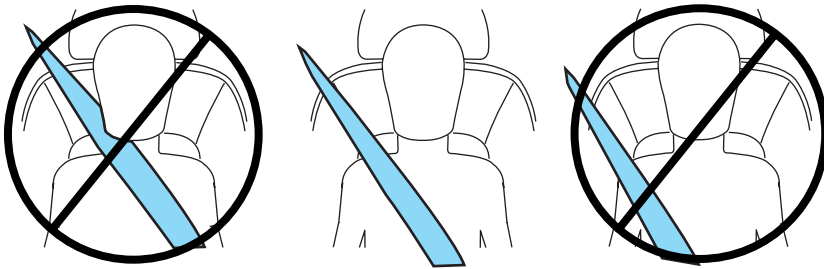

If the booster seat slides on the vehicle seat, placing a rubberized mesh sold as shelf or carpet liner under the booster seat may improve this condition.

The importance of shoulder belts

Using a booster without a shoulder belt increases the risk of a child's head hitting a hard surface in a collision. For this reason, you should never use a booster seat with a lap belt only. It is best to use a booster seat with lap/shoulder belts in the back seat- the safest place for children to ride.



Move a child to a different seating location if the shoulder belt does not stay positioned on the shoulder during use.



Follow all instructions provided by the manufacturer of the booster seat.



Never put the shoulder belt under a child's arm or behind the back because it eliminates the protection for the upper part of the body and may increase the risk of injury or death in a collision.

Seating and Safety Restraints



Never use pillows, books, or towels to boost a child. They can slide around and increase the likelihood of injury or death in a collision.

SAFETY SEATS FOR CHILDREN

Child and infant or child safety seats

Use a safety seat that is recommended for the size and weight of the child. Carefully follow all of the manufacturer's instructions with the safety seat you put in your vehicle. If you do not install and use the safety seat properly, the child may be injured in a sudden stop or collision.

When installing a child safety seat:

- Review and follow the information presented in the *Airbag Supplemental Restraint System* section in this chapter.
- Use the correct safety belt buckle for that seating position (the buckle closest to the direction the tongue is coming from).
- Insert the belt tongue into the proper buckle until you hear a snap and feel it latch. Make sure the tongue is securely fastened in the buckle.
- Keep the buckle release button pointing up and away from the safety seat, with the tongue between the child seat and the release button, to prevent accidental unbuckling.
- Place seat back in upright position.
- Put the safety belt in the automatic locking mode. Refer to *Automatic locking mode* (passenger side front seating position-Regular Cab) (passenger side front and rear seating positions-SuperCrew and SuperCab) (if equipped).

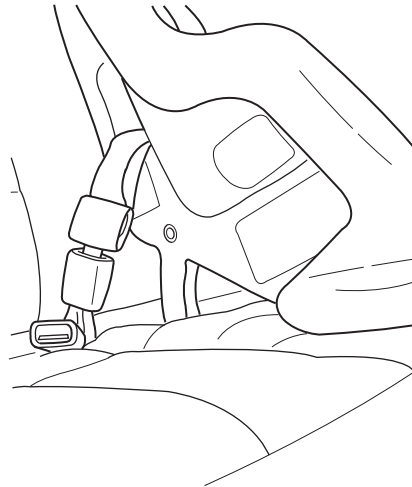

Seating and Safety Restraints

- LATCH lower anchors are recommended for use by children up to 22 kg (48 pounds) in a child restraint. Top tether anchors can be used for children up to 27 kg (60 pounds) in a child restraint, and to provide upper torso restraint for children up to 36 kg (80 pounds) using an upper torso harness and a belt-positioning booster.

Ford recommends the use of a child safety seat having a top tether strap. Install the child safety seat in a seating position with LATCH and tether anchors. For more information on top tether straps and anchors, refer to *Attaching safety seats with tether straps* in this chapter. For more information of LATCH anchors refer to *Attaching safety seats with LATCH (Lower Anchors and Tethers for Children) attachments* in this chapter.



Carefully follow all of the manufacturer's instructions included with the safety seat you put in your vehicle. If you do not install and use the safety seat properly, the child may be injured in a sudden stop or collision.

Installing child safety seats with combination lap and shoulder belts



Airbags can kill or injure a child in a child seat. **NEVER** place a rear-facing child seat in front of an active airbag. If you must use a forward-facing child seat in the front seat, move the seat all the way back.



Children 12 and under should be properly restrained in the rear seat whenever possible.

If you are using a Regular Cab center seat, see *Installing child safety seats in cinch tongue combination lap and shoulder belt seating position* later in this chapter for instructions.

Seating and Safety Restraints

1. Position the child safety seat in a seat with a combination lap and shoulder belt.

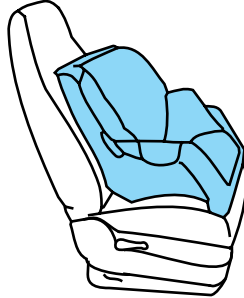

2. Pull down on the shoulder belt and then grasp the shoulder belt and lap belt together.

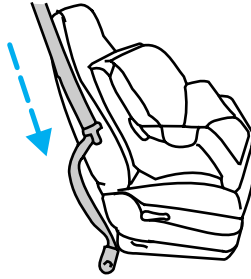

3. While holding the shoulder and lap belt portions together, route the tongue through the child seat according to the child seat manufacturer's instructions. Be sure the belt webbing is not twisted.

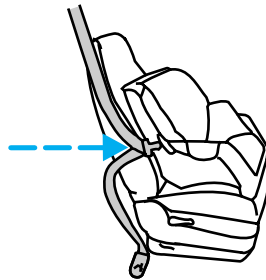

Seating and Safety Restraints

4. Insert the belt tongue into the proper buckle (the buckle closest to the direction the tongue is coming from) for that seating position until you hear a snap and feel the latch engage. Make sure the tongue is latched securely by pulling on it.

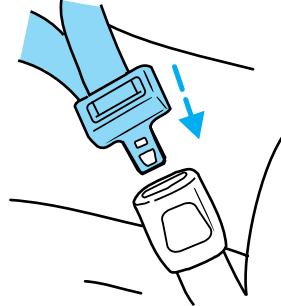

5. To put the retractor in the automatic locking mode, grasp the shoulder portion of the belt and pull downward until all of the belt is pulled out and a click is heard.

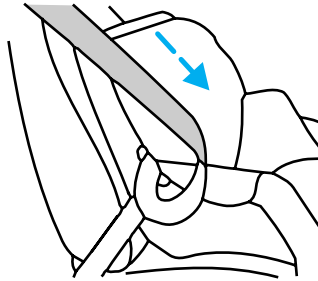

6. Allow the belt to retract. The belt will click as it retracts to indicate it is in the automatic locking mode.

7. Pull the lap belt portion across the child seat toward the buckle and pull up on the shoulder belt while pushing down with your knee on the child seat.

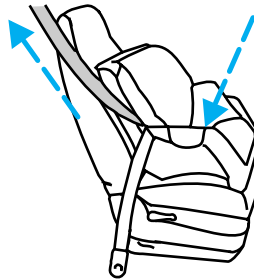

Seating and Safety Restraints

8. Allow the safety belt to retract to remove any slack in the belt.

9. Before placing the child in the seat, forcibly move the seat forward and back to make sure the seat is securely held in place. To check this, grab the seat at the belt path and attempt to move it side to side and forward. There should be no more than one inch of movement for proper installation.

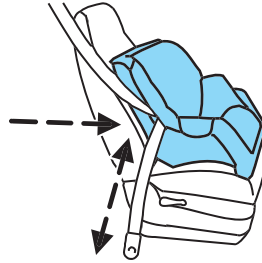

10. Try to pull the belt out of the retractor to make sure the retractor is in the automatic locking mode (you should not be able to pull more belt out). If the retractor is not locked, unbuckle the belt and repeat Steps two through nine.

Check to make sure the child seat is properly secured before each use.

Installing child safety seats in cinch tongue combination lap and shoulder belt seating position (Regular Cab Center seating position Only)

If you are using a regular cab center seat, see *Center front safety belt (Regular Cab center seating position only)* earlier in this chapter for instructions on attaching the mini-buckle.

The belt webbing below the tongue is the lap portion of the combination lap/shoulder belt, and the belt webbing above the tongue is the shoulder belt portion of the combination lap/shoulder belt.



Always use both lap and shoulder safety belt in the Regular Cab center seating position.

1. Position the child safety seat in the Regular Cab center front seat.

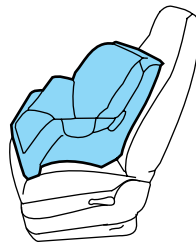

Seating and Safety Restraints

2. If the center lap/shoulder safety belt has been disconnected from the seat to carry large cargo behind the seat, reconnect it by buckling the small buckle on the end of the belt into the mini-buckle on the driver's side.

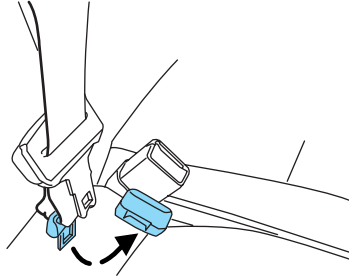

Airbags can kill or injure a child in a child seat. If you must use a forward-facing child seat in the front seat, move seat all the way back.



Rear facing child seats should NEVER be placed in front of an active airbag.

3. Slide the tongue up the webbing.

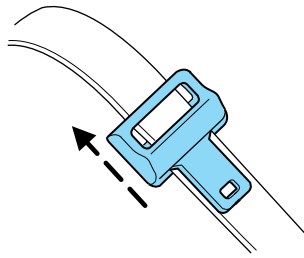

4. While holding both shoulder and lap portions next to the tongue, route the tongue and webbing through the child seat according to the child seat manufacturer's instructions. Be sure that the belt webbing is not twisted.

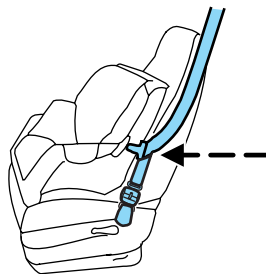

Seating and Safety Restraints

5. Insert the belt tongue into the proper buckle for that seating positions until you hear a snap and feel it latch. Make sure the tongue is securely latched to the buckle by pulling on the tongue.

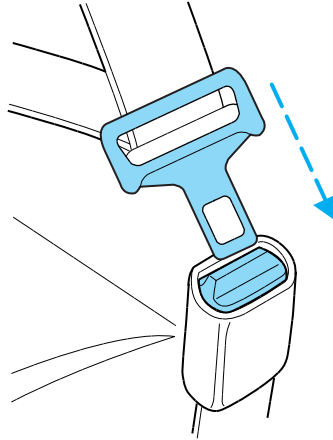

6. While pushing down with your knee on the child seat pull up on the shoulder belt portion to tighten the lap belt portion of the combination lap and shoulder belt.

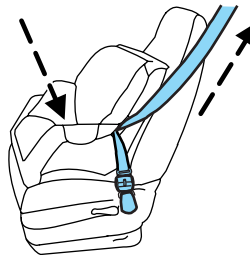

7. Allow the safety belt to retract and remove any slack in the belt to securely tighten the child safety seat in the vehicle.

8. Before placing the child into the child seat, forcibly pull the child seat forward and back to make sure that the seat is held securely in place. To check this, grab the seat at the belt path and attempt to move it side to side and forward and back. There should be no more than one inch of movement for proper installation.

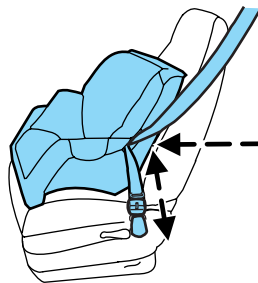

Seating and Safety Restraints

9. Check from time to time to be sure that there is no slack in the lap/shoulder belt. The shoulder belt must be snug to keep the lap belt tight during a collision.

Installing child safety seats in the front row lap belt seating positions (SuperCab and SuperCrew)



Installing a child safety seat in the front row lap seating position should be avoided if at all possible. The passenger sensing system does not recognize child seats in the front center seating position.



Never place a rear-facing child seat in the front center seating position of a vehicle with rear seating positions.

1. Lengthen the lap belt. To lengthen the belt, hold the tongue so that its bottom is perpendicular to the direction of webbing while sliding the tongue up the webbing.
2. Place the child safety seat in the center seating position.
3. Route the tongue and webbing through the child seat according to the child seat manufacturer's instructions.
4. Insert the belt tongue into the proper buckle for the center seating position until you hear a snap and feel it latch. Make sure the tongue is securely fastened to the buckle by pulling on tongue.
5. Push down on the child seat while pulling on the loose end of the lap belt webbing to tighten the belt.
6. If you are installing a forward facing child seat, attach and tighten any top tether strap.
7. Before placing the child into the child seat, forcibly tilt the child seat from side to side and in forward direction to make sure that the seat is held securely in place. If the child seat moves excessively, repeat Steps 5 through 7, try a different child safety seat, or properly install the child seat in a different position.

Attaching child safety seats with tether straps

Most new forward-facing child safety seats include a tether strap which goes over the back of the seat and hooks to an anchoring point. Tether straps are available as an accessory for many older safety seats. Contact the manufacturer of your child seat for information about ordering a tether strap.

160

Seating and Safety Restraints

The passenger seats of your vehicle are equipped with built-in tether strap anchors located behind the seats as described below.

The tether anchors in your vehicle may be loops of webbing above the seatback or an anchor bracket behind the seat on the rear edge of the seat cushion.

The rear seat in the SuperCab and SuperCrew has three straps along the top of the seatback that function as both routing loops for the tether straps and anchor loops.

The tether strap anchors in your vehicle are in the following positions (shown from top view):

 Attach the tether strap only to the appropriate tether anchor as shown. The tether strap may not work properly if attached somewhere other than the correct tether anchor.

• F150 Regular Cab

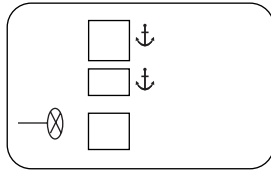

• F150 SuperCrew and SuperCab

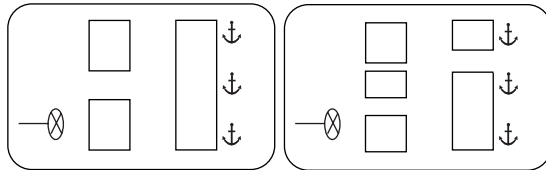

Front seat tether strap attachment

1. Position the child safety seat on the seat cushion.
2. Route the child safety seat tether strap over the back of the seat and under the head restraint.
3. Locate the correct anchor for the selected seating position.

Seating and Safety Restraints

- You may need to pull the seatback forward to access the tether anchors. Make sure the seatback is locked in the upright position before installing the child seat.
- 4. Clip the tether strap to the anchor as shown.
- Front seat Regular Cab passenger side

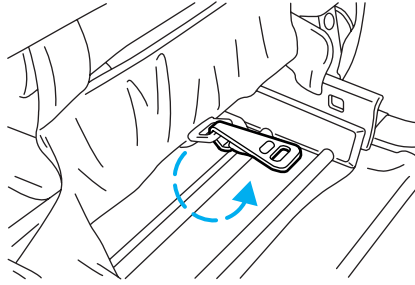

- Front seat Regular Cab center (located on back panel)

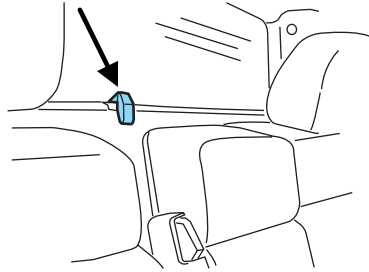

If the tether strap is clipped incorrectly, the child safety seat may not be retained properly in the event of a collision.

5. Install the child safety seat tightly using the LATCH anchors or safety belts. Follow the instructions in this chapter.

6. Tighten the child safety seat tether strap according to the manufacturer's instructions.

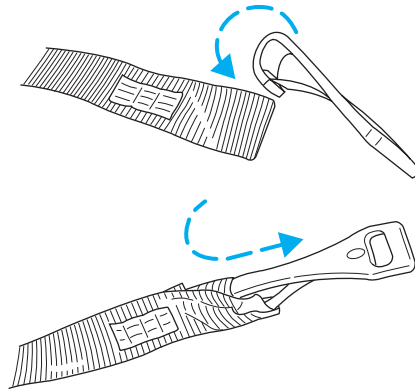

Seating and Safety Restraints



If the safety seat is not anchored properly, the risk of a child being injured in a collision greatly increases.

Rear seat tether strap attachment

There are three loops of webbing just above the back of the rear seat (along the bottom edge of the rear window) in the SuperCab and SuperCrew. These loops are to be used as both routing loops and anchor loops for up to three child safety seat tether straps. For example, the center loop can be used as a routing loop for a child safety seat in the center rear seat and as an anchoring loop for child seats installed in the outboard rear seats.

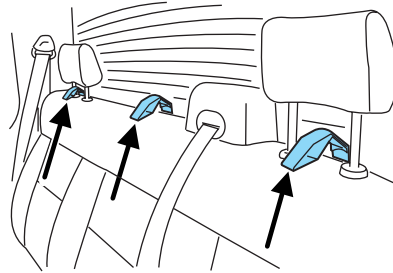

Many tether straps cannot be tightened if the tether strap is hooked to the loop directly behind the child seat. To provide a tight tether strap:

1. Route the tether strap under the head restraint and through the loop directly behind the child seat.



Seating and Safety Restraints

2. Route the tether strap behind the head restraint supports to a loop behind an adjacent seating position, and hook the strap hook onto the loop. If using the driver's side, pass the strap behind the shoulder belt mounting for the center seat.

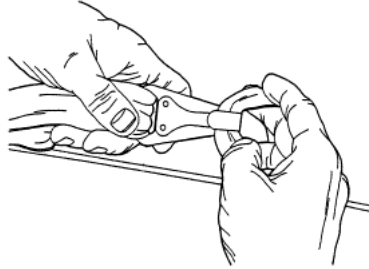

- Always put the tether strap through the routing loop. The head restraint support post will hold the child seat tightly, but the head restraint post is not strong enough to hold the child seat during a collision.

3. Install the child safety seat tightly using the LATCH anchors or safety belts. Follow the instructions in this chapter.

4. Tighten the tether strap according to the child seat manufacturer's instructions.

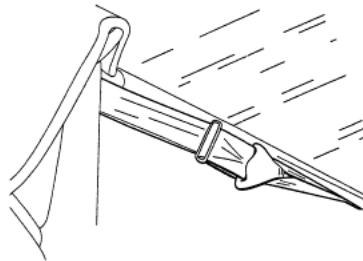

Attaching safety seats with LATCH (Lower Anchors and Tethers for Children) attachments for child seat anchors

Some child safety seats have two rigid or webbing mounted attachments that connect to two anchors at certain seating positions in your vehicle. This type of child seat eliminates the need to use safety belts to attach the child seat. For forward-facing child seats, the tether strap must also be attached to the proper tether anchor. See *Attaching safety seats with tether straps* in this chapter.

Seating and Safety Restraints

Your vehicle is equipped with LATCH anchors for child seat installation at the following seating positions (LATCH is not available on F150 Regular cab) :

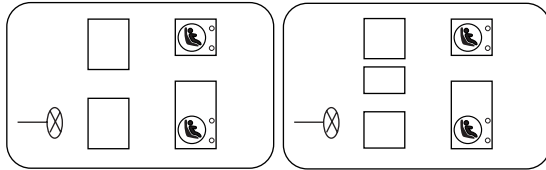

- F150 SuperCab and SuperCrew

The anchors on both sides of the center of the rear seat are provided for child seats at the outboard seats, and are further apart than the pairs of lower anchors for child seat installation at other seats. DO NOT install child seats with LATCH attachments (rigid or mounted on belt webbing) to the lower anchors at the center rear seat. If you install a child seat at the center rear position, use the vehicle belt and the top tether anchor.



Never attach two LATCH child safety seats to the same anchor. In a crash, one anchor may not be strong enough to hold two child safety seat attachments and may break, causing serious injury or death.

The lower anchors for child seat installation are located at the rear section of the seat between the cushion and seat back. The LATCH anchors are below the locator buttons on the seat back.

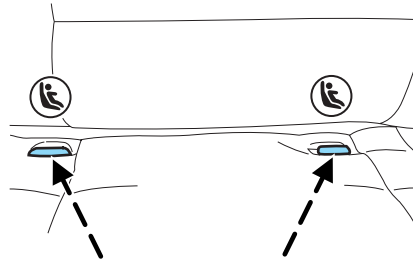

Follow the child seat manufacturer's instructions to properly install a child seat with LATCH attachments.



Attach LATCH lower attachments of the child seat only to the anchors shown.

Seating and Safety Restraints

If you install a child seat with rigid LATCH attachments, do not tighten the tether strap enough to lift the child seat off the vehicle seat cushion when the child is seated in it. Keep the tether strap just snug without lifting the front of the child seat. Keeping the child seat just touching the vehicle seat gives the best protection in a severe crash.

Each time you use the safety seat, check that the seat is properly attached to the lower anchors and tether anchor. Try to tilt the child seat from side to side. Also try to tug the seat forward. Check to see if the anchors hold the seat in place.





If the safety seat is not anchored properly, the risk of a child being injured in a crash greatly increases.

Tires, Wheels and Loading

NOTICE TO UTILITY VEHICLE AND TRUCK OWNERS

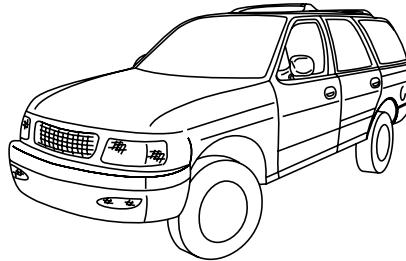
Utility vehicles and trucks handle differently than passenger cars in the various driving conditions that are encountered on streets, highways and off-road. Utility vehicles and trucks are not designed for cornering at speeds as high as passenger cars any more than low-slung sports cars are designed to perform satisfactorily under off-road conditions.



 Utility vehicles have a significantly higher rollover rate than other types of vehicles. To reduce the risk of serious injury or death from a rollover or other crash you must:

- Avoid sharp turns and abrupt maneuvers;
- Drive at safe speeds for the conditions;
- Keep tires properly inflated;
- Never overload or improperly load your vehicle; and
- Make sure every passenger is properly restrained.

 In a rollover crash, an unbelted person is significantly more likely to die than a person wearing a seat belt. All occupants must wear seat belts and children/infants must use appropriate restraints to minimize the risk of injury or ejection.

Study your *Owner's Guide* and any supplements for specific information about equipment features, instructions for safe driving and additional precautions to reduce the risk of an accident or serious injury.

VEHICLE CHARACTERISTICS

4WD and AWD Systems (if equipped)

A vehicle equipped with AWD or 4WD (when selected) has the ability to use all four wheels to power itself. This increases traction which may enable you to safely drive over terrain and road conditions that a conventional two-wheel drive vehicle cannot.

Tires, Wheels and Loading

Power is supplied to all four wheels through a transfer case or power transfer unit. 4WD vehicles allow you to select different drive modes as necessary. Information on transfer case operation and shifting procedures can be found in the *Driving* chapter. Information on

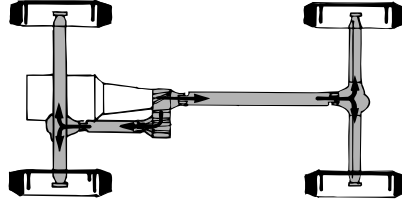

transfer case maintenance can be found in the *Maintenance and Specifications* chapter. You should become thoroughly familiar with this information before you operate your vehicle.

On some 4WD models, the initial shift from two-wheel drive to 4WD while the vehicle is moving can cause a momentary clunk and ratcheting sound. These sounds are normal as the front drivetrain comes up to speed and is not cause for concern.



Do not become overconfident in the ability of 4WD and AWD vehicles. Although a 4WD or AWD vehicle may accelerate better than two-wheel drive vehicle in low traction situations, it won't stop any faster than two-wheel drive vehicles. Always drive at a safe speed.

How your vehicle differs from other vehicles

SUV and trucks can differ from some other vehicles in a few noticeable ways. Your vehicle may be:

- Higher – to allow higher load carrying capacity and to allow it to travel over rough terrain without getting hung up or damaging underbody components.
- Shorter – to give it the capability to approach inclines and drive over the crest of a hill without getting hung up or damaging underbody components. All other things held equal, a shorter wheelbase may make your vehicle quicker to respond to steering inputs than a vehicle with a longer wheelbase.

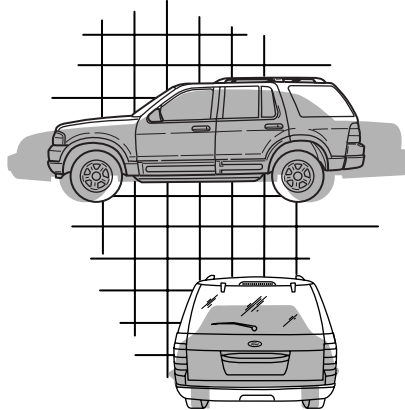

Tires, Wheels and Loading

- Narrower — to provide greater maneuverability in tight spaces, particularly in off-road use.

As a result of the above dimensional differences, SUV's and trucks often will have a higher center of gravity and a greater difference in center of gravity between the loaded and unloaded condition.

These differences that make your vehicle so versatile also make it handle differently than an ordinary passenger car.

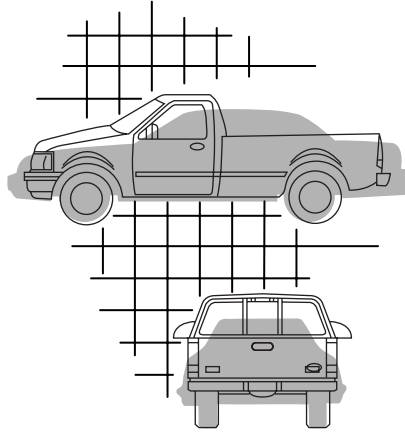

INFORMATION ABOUT UNIFORM TIRE QUALITY GRADING

New vehicles are fitted with tires that have a rating on them called Tire Quality Grades. The Quality grades can be found where applicable on the tire sidewall between tread shoulder and maximum section width. For example:

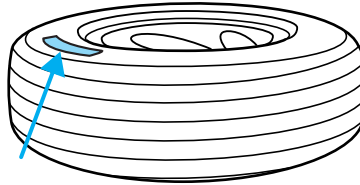

- **Treadwear 200 Traction AA Temperature A**

These Tire Quality Grades are determined by standards that the United States Department of Transportation has set.

Tire Quality Grades apply to new pneumatic tires for use on passenger cars. They do not apply to deep tread, winter-type snow tires, space-saver or temporary use spare tires, tires with nominal rim diameters of 10 to 12 inches or limited production tires as defined in Title 49 Code of Federal Regulations Part 575.104(c)(2).

U.S. Department of Transportation-Tire quality grades: The U.S. Department of Transportation requires Ford Motor Company to give you the following information about tire grades exactly as the government has written it.

Tires, Wheels and Loading

Treadwear

The treadwear grade is a comparative rating based on the wear rate of the tire when tested under controlled conditions on a specified government test course. For example, a tire graded 150 would wear one and one-half (1 1/2) times as well on the government course as a tire graded 100. The relative performance of tires depends upon the actual conditions of their use, however, and may depart significantly from the norm due to variations in driving habits, service practices, and differences in road characteristics and climate.

Traction AA A B C

The traction grades, from highest to lowest are AA, A, B, and C. The grades represent the tire's ability to stop on wet pavement as measured under controlled conditions on specified government test surfaces of asphalt and concrete. A tire marked C may have poor traction performance.



The traction grade assigned to this tire is based on straight-ahead braking traction tests, and does not include acceleration, cornering, hydroplaning or peak traction characteristics.

Temperature A B C

The temperature grades are A (the highest), B and C, representing the tire's resistance to the generation of heat and its ability to dissipate heat when tested under controlled conditions on a specified indoor laboratory test wheel. Sustained high temperature can cause the material of the tire to degenerate and reduce tire life, and excessive temperature can lead to sudden tire failure. The grade C corresponds to a level of performance which all passenger car tires must meet under the Federal Motor Vehicle Safety Standard No. 109. Grades B and A represent higher levels of performance on the laboratory test wheel than the minimum required by law.



The temperature grade for this tire is established for a tire that is properly inflated and not overloaded. Excessive speed, underinflation, or excessive loading, either separately or in combination, can cause heat buildup and possible tire failure.

TIRES

Tires are designed to give many thousands of miles of service, but they must be maintained in order to get the maximum benefit from them.

170

Tires, Wheels and Loading

Glossary of tire terminology

- **Tire label:** A label showing the OE (Original Equipment) tire sizes, recommended inflation pressure and the maximum weight the vehicle can carry.
- **Tire Identification Number (TIN):** A number on the sidewall of each tire providing information about the tire brand and manufacturing plant, tire size and date of manufacture. Also referred to as DOT code.
- **Inflation pressure:** A measure of the amount of air in a tire.
- **Standard load:** A class of P-metric or Metric tires designed to carry a maximum load at 35 psi [37 psi (2.5 bar) for Metric tires]. Increasing the inflation pressure beyond this pressure will not increase the tire's load carrying capability.
- **Extra load:** A class of P-metric or Metric tires designed to carry a heavier maximum load at 41 psi [43 psi (2.9 bar) for Metric tires]. Increasing the inflation pressure beyond this pressure will not increase the tire's load carrying capability.
- **kPa:** Kilopascal, a metric unit of air pressure.
- **PSI:** Pounds per square inch, a standard unit of air pressure.
- **Cold inflation pressure:** The tire pressure when the vehicle has been stationary and out of direct sunlight for an hour or more and prior to the vehicle being driven for 1 mile (1.6 km).
- **Recommended inflation pressure:** The cold inflation pressure found on the Safety Compliance Certification Label or Tire Label located on the B-Pillar or the edge of the driver's door.
- **B-pillar:** The structural member at the side of the vehicle behind the front door.
- **Bead area of the tire:** Area of the tire next to the rim.
- **Sidewall of the tire:** Area between the bead area and the tread.
- **Tread area of the tire:** Area of the perimeter of the tire that contacts the road when mounted on the vehicle.
- **Rim:** The metal support (wheel) for a tire or a tire and tube assembly upon which the tire beads are seated.

INFLATING YOUR TIRES

Safe operation of your vehicle requires that your tires are properly inflated. Remember that a tire can lose up to half of its air pressure without appearing flat.

Tires, Wheels and Loading

Every day before you drive, check your tires. If one looks lower than the others, use a tire gauge to check pressure of all tires and adjust if required.

At least once a month and before long trips, inspect each tire and check the tire pressure with a tire gauge (including spare, if equipped). Inflate all tires to the inflation pressure recommended by Ford Motor Company.

Use a tire gauge to check the tire inflation pressure, including the spare (if equipped), at least monthly and before long trips. You are strongly urged to buy a reliable tire pressure gauge, as automatic service station gauges may be inaccurate. Ford recommends the use of a digital or dial-type tire pressure gauge rather than a stick-type tire pressure gauge.

Use the recommended cold inflation pressure for optimum tire performance and wear. Under-inflation or over-inflation may cause uneven treadwear patterns.



Under-inflation is the most common cause of tire failures and may result in severe tire cracking, tread separation or "blowout", with unexpected loss of vehicle control and increased risk of injury. Under-inflation increases sidewall flexing and rolling resistance, resulting in heat buildup and internal damage to the tire. It also may result in unnecessary tire stress, irregular wear, loss of vehicle control and accidents. A tire can lose up to half of its air pressure and not appear to be flat!

Always inflate your tires to the Ford recommended inflation pressure even if it is less than the maximum inflation pressure information found on the tire. The Ford recommended tire inflation pressure is found on the Safety Compliance Certification Label or Tire Label which is located on the B-Pillar or the edge of the driver's door. Failure to follow the tire pressure recommendations can cause uneven treadwear patterns and adversely affect the way your vehicle handles.

Maximum Permissible Inflation Pressure is the tire manufacturer's maximum permissible pressure and/or the pressure at which the maximum load can be carried by the tire. This pressure is normally higher than the manufacturer's recommended cold inflation pressure which can be found on the Safety Compliance Certification Label or Tire Label which is located on the B-Pillar or the edge of the driver's door. The cold inflation pressure should never be set lower than the recommended pressure on the Safety Compliance Certification Label or Tire Label.

When weather temperature changes occur, tire inflation pressures also change. A 10° F (6° C) temperature drop can cause a corresponding

Tires, Wheels and Loading

drop of 1 psi (7 kPa) in inflation pressure. Check your tire pressures frequently and adjust them to the proper pressure which can be found on the Safety Compliance Certification Label or Tire Label.

To check the pressure in your tire(s):

1. Make sure the tires are cool, meaning they are not hot from driving even a mile.

If you are checking tire pressure when the tire is hot, (i.e. driven more than 1 mile [1.6 km]), never “bleed” or reduce air pressure. The tires are hot from driving and it is normal for pressures to increase above recommended cold pressures. A hot tire at or below recommended cold inflation pressure could be significantly under-inflated.

Note: If you have to drive a distance to get air for your tire(s), check and record the tire pressure first and add the appropriate air pressure when you get to the pump. It is normal for tires to heat up and the air pressure inside to go up as you drive.

2. Remove the cap from the valve on one tire, then firmly press the tire gauge onto the valve and measure the pressure.

3. Add enough air to reach the recommended air pressure

Note: If you overfill the tire, release air by pushing on the metal stem in the center of the valve. Then recheck the pressure with your tire gauge.

4. Replace the valve cap.

5. Repeat this procedure for each tire, including the spare.

Note: Some spare tires operate at a higher inflation pressure than the other tires. For T-type/mini-spare tires (see *T-Type/Mini-Spare Tire Information* section for description): Store and maintain at 60psi (4.15 bar). For Full Size and Dissimilar spare tires (see *Dissimilar Spare Tire/Wheel Information* section for description): Store and maintain at the higher of the front and rear inflation pressure as shown on the Tire Label.

6. Visually inspect the tires to make sure there are no nails or other objects embedded that could poke a hole in the tire and cause an air leak.

7. Check the sidewalls to make sure there are no gouges, cuts or bulges.

TIRE CARE

Inspecting your tires

Periodically inspect the tire treads for uneven or excessive wear and remove objects such as stones, nails or glass that may be wedged in the

Tires, Wheels and Loading

tread grooves. Check for holes or cuts that may permit air leakage from the tire and make necessary repairs. Also inspect the tire sidewalls for cracking, cuts, bruises and other signs of damage or excessive wear. If internal damage to the tire is suspected, have the tire demounted and inspected in case it needs to be repaired or replaced. For your safety, tires that are damaged or show signs of excessive wear should not be used because they are more likely to blow out or fail.

Improper or inadequate vehicle maintenance can cause tires to wear abnormally. Inspect all your tires, including the spare, frequently, and replace them if one or more of the following conditions exist:

Tire wear

When the tread is worn down to 1/16th of an inch (2 mm), tires must be replaced to help prevent your vehicle from skidding and hydroplaning. Built-in treadwear indicators, or “wear bars”, which look like narrow strips of smooth rubber across the tread will appear on the tire when the tread is worn down to 1/16th of an inch (2 mm). When the tire tread wears down to the same height as these “wear bars”, the tire is worn out and must be replaced.

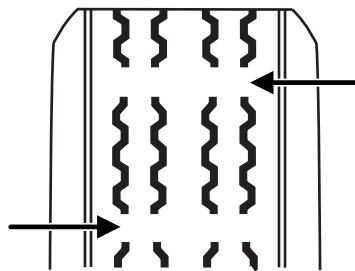

Damage

Periodically inspect the tire treads and sidewalls for damage (such as bulges in the tread or sidewalls, cracks in the tread groove and separation in the tread or sidewall). If damage is observed or suspected have the tire inspected by a tire professional. Tires can be damaged during off-road use, so inspection after off-road use is also recommended.



Age

Tires degrade over time depending on many factors such as weather, storage conditions, and conditions of use (load, speed, inflation pressure, etc.) the tires experience throughout their lives. In general, tires should be replaced after six years regardless of tread wear. However, heat caused by hot climates or frequent high loading conditions can accelerate the aging process and may require tires to be replaced more frequently.

You should replace your spare tire when you replace the road tires or after six years due to aging even if it has not been used.

Tires, Wheels and Loading

U.S. DOT Tire Identification Number (TIN)

Both U.S. and Canada Federal regulations require tire manufacturers to place standardized information on the sidewall of all tires. This information identifies and describes the fundamental characteristics of the tire and also provides a U.S. DOT Tire Identification Number for safety standard certification and in case of a recall.

This begins with the letters "DOT" and indicates that the tire meets all federal standards. The next two numbers or letters are the plant code designating where it was manufactured, the next two are the tire size code and the last four numbers represent the week and year the tire was built. For example, the numbers 317 mean the 31st week of 1997. After 2000 the numbers go to four digits. For example, 2501 means the 25th week of 2001. The numbers in between are identification codes used for traceability. This information is used to contact customers if a tire defect requires a recall.

Tire Replacement Requirements

Your vehicle is equipped with tires designed to provide a safe ride and handling capability.



Only use replacement tires and wheels that are the same size and type (such as P-metric versus LT-metric or all-season versus all-terrain) as those originally provided by Ford. The recommended tire and wheel size may be found on either the Safety Compliance Certification Label or the Tire Label which is located on the B-Pillar or edge of the driver's door. If this information is not found on these labels then you should consult your Ford dealer. Use of any tire or wheel not recommended by Ford can affect the safety and performance of your vehicle, which could result in an increased risk of loss of vehicle control, vehicle rollover, personal injury and death. Additionally the use of non-recommended tires and wheels could cause steering, suspension, axle or transfer case/power transfer unit failure. If you have questions regarding tire replacement, see an authorized dealer.

Tires, Wheels and Loading



When mounting replacement tires and wheels, you should not exceed the maximum pressure indicated on the sidewall of the tire to set the beads without additional precautions listed below. If the beads do not seat at the maximum pressure indicated, re-lubricate and try again.

When inflating the tire for mounting pressures up to 20 psi greater than the maximum pressure on the tire sidewall, the following precautions must be taken to protect the person mounting the tire:

1. Make sure that you have the correct tire and wheel size.
2. Lubricate the tire bead and wheel bead seat area again.
3. Stand at a minimum of 12 feet away from the tire wheel assembly.
4. Use both eye and ear protection.

For a mounting pressure more than 20 psi greater than the maximum pressure, a Ford Dealer or other tire service professional should do the mounting.

Always inflate steel carcass tires with a remote air fill with the person inflating standing at a minimum of 12 ft. away from the tire wheel assembly.

Important: Remember to replace the wheel valve stems when the road tires are replaced on your vehicle.

It is recommended that the two front tires or two rear tires generally be replaced as a pair.

The tire pressure sensors mounted in the wheels (originally installed on your vehicle) are not designed to be used in aftermarket wheels.

The use of wheels or tires not recommended by Ford Motor Company may affect the operation of your Tire Pressure Monitoring System.

If the TPMS indicator is flashing, your TPMS is malfunctioning. Your replacement tire might be incompatible with your TPMS, or some component of the TPMS may be damaged.

Safety practices

Driving habits have a great deal to do with your tire mileage and safety.

- Observe posted speed limits
- Avoid fast starts, stops and turns
- Avoid potholes and objects on the road
- Do not run over curbs or hit the tire against a curb when parking

Tires, Wheels and Loading



If your vehicle is stuck in snow, mud, sand, etc., **do not** rapidly spin the tires; spinning the tires can tear the tire and cause an explosion. A tire can explode in as little as three to five seconds.



Do not spin the wheels at over 35 mph (56 km/h). The tires may fail and injure a passenger or bystander.

Highway hazards

No matter how carefully you drive there's always the possibility that you may eventually have a flat tire on the highway. Drive slowly to the closest safe area out of traffic. This may further damage the flat tire, but your safety is more important.

If you feel a sudden vibration or ride disturbance while driving, or you suspect your tire or vehicle has been damaged, immediately reduce your speed. Drive with caution until you can safely pull off the road. Stop and inspect the tires for damage. If a tire is under-inflated or damaged, deflate it, remove wheel and replace it with your spare tire and wheel. If you cannot detect a cause, have the vehicle towed to the nearest repair facility or tire dealer to have the vehicle inspected.

Tire and wheel alignment

A bad jolt from hitting a curb or pothole can cause the front end of your vehicle to become misaligned or cause damage to your tires. If your vehicle seems to pull to one side when you're driving, the wheels may be out of alignment. Have an authorized dealer check the wheel alignment periodically.

Wheel misalignment in the front or the rear can cause uneven and rapid treadwear of your tires and should be corrected by an authorized dealer. Front wheel drive (FWD) vehicles and those with an independent rear suspension (if equipped) may require alignment of all four wheels.

The tires should also be balanced periodically. An unbalanced tire and wheel assembly may result in irregular tire wear.

Tire rotation

Rotating your tires at the recommended interval (as indicated in the *scheduled maintenance information* that comes with your vehicle) will help your tires wear more evenly, providing better tire performance and longer tire life. Unless otherwise specified, rotate the tires approximately every 5,000 miles (8,000 km).

Tires, Wheels and Loading

- Rear Wheel Drive (RWD) vehicles/Four Wheel Drive (4WD)/ All Wheel Drive (AWD) vehicles (front tires at top of diagram)

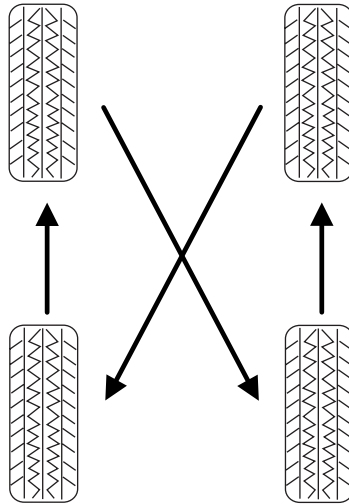

Sometimes irregular tire wear can be corrected by rotating the tires.

Note: If your tires show uneven wear ask an authorized dealer to check for and correct any wheel misalignment, tire imbalance or mechanical problem involved before tire rotation.

Note: Your vehicle may be equipped with a dissimilar spare tire/wheel. A dissimilar spare tire/wheel is defined as a spare tire and/or wheel that is different in brand, size or appearance from the road tires and wheels. If you have a dissimilar spare tire/wheel it is intended for temporary use only and should not be used in a tire rotation.

Note: After having your tires rotated, inflation pressure must be checked and adjusted to the vehicle requirements.

INFORMATION CONTAINED ON THE TIRE SIDEWALL

Both U.S. and Canada Federal regulations require tire manufacturers to place standardized information on the sidewall of all tires. This information identifies and describes the fundamental characteristics of the tire and also provides a U.S. DOT Tire Identification Number for safety standard certification and in case of a recall.

178

Tires, Wheels and Loading

Information on “P” type tires

P215/65R15 95H is an example of a tire size, load index and speed rating. The definitions of these items are listed below. (Note that the tire size, load index and speed rating for your vehicle may be different from this example.)

1. **P:** Indicates a tire, designated by the Tire and Rim Association (T&RA), that may be used for service on cars, SUVs, minivans and light trucks.

Note: If your tire size does not begin with a letter this may mean it is designated by either ETRTO (European Tire and Rim Technical Organization) or JATMA (Japan Tire Manufacturing Association).

2. **215:** Indicates the nominal width of the tire in millimeters from sidewall edge to sidewall edge. In general, the larger the number, the wider the tire.

3. **65:** Indicates the aspect ratio which gives the tire’s ratio of height to width.

4. **R:** Indicates a “radial” type tire.

5. **15:** Indicates the wheel or rim diameter in inches. If you change your wheel size, you will have to purchase new tires to match the new wheel diameter.

6. **95:** Indicates the tire’s load index. It is an index that relates to how much weight a tire can carry. You may find this information in your *Owner’s Guide*. If not, contact a local tire dealer.

Note: You may not find this information on all tires because it is not required by federal law.

7. **H:** Indicates the tire’s speed rating. The speed rating denotes the speed at which a tire is designed to be driven for extended periods of time under a standard condition of load and inflation pressure. The tires on your vehicle may operate at different conditions for load and inflation pressure. These speed ratings may need to be adjusted for the difference in conditions. The ratings range from 81 mph (130 km/h) to 186 mph (299 km/h). These ratings are listed in the following chart.

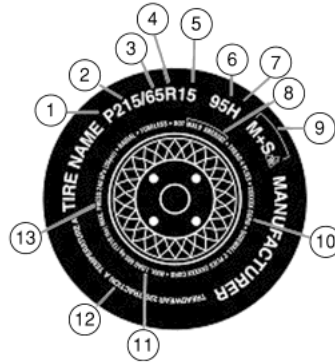

Tires, Wheels and Loading

Note: You may not find this information on all tires because it is not required by federal law.

Letter rating	Speed rating - mph (km/h)
M	81 mph (130 km/h)
N	87 mph (140 km/h)
Q	99 mph (159 km/h)
R	106 mph (171 km/h)
S	112 mph (180 km/h)
T	118 mph (190 km/h)
U	124 mph (200 km/h)
H	130 mph (210 km/h)
V	149 mph (240 km/h)
W	168 mph (270 km/h)
Y	186 mph (299 km/h)

Note: For tires with a maximum speed capability over 149 mph (240 km/h), tire manufacturers sometimes use the letters ZR. For those with a maximum speed capability over 186 mph (299 km/h), tire manufacturers always use the letters ZR.

8. U.S. DOT Tire Identification Number (TIN): This begins with the letters "DOT" and indicates that the tire meets all federal standards. The next two numbers or letters are the plant code designating where it was manufactured, the next two are the tire size code and the last four numbers represent the week and year the tire was built. For example, the numbers 317 mean the 31st week of 1997. After 2000 the numbers go to four digits. For example, 2501 means the 25th week of 2001. The numbers in between are identification codes used for traceability. This information is used to contact customers if a tire defect requires a recall.

9. M+S or M/S: Mud and Snow, or

AT: All Terrain, or

AS: All Season.

10. Tire Ply Composition and Material Used: Indicates the number of plies or the number of layers of rubber-coated fabric in the tire tread and sidewall. Tire manufacturers also must indicate the ply materials in the tire and the sidewall, which include steel, nylon, polyester, and others.

11. Maximum Load: Indicates the maximum load in kilograms and pounds that can be carried by the tire. Refer to the Safety Compliance Certification Label, which is located on the B-Pillar or the edge of the driver's door, for the correct tire pressure for your vehicle.

Tires, Wheels and Loading

12. Treadwear, Traction and Temperature Grades

- **Treadwear:** The treadwear grade is a comparative rating based on the wear rate of the tire when tested under controlled conditions on a specified government test course. For example, a tire graded 150 would wear one and one-half ($1\frac{1}{2}$) times as well on the government course as a tire graded 100.
- **Traction:** The traction grades, from highest to lowest are AA, A, B, and C. The grades represent the tire's ability to stop on wet pavement as measured under controlled conditions on specified government test surfaces of asphalt and concrete. A tire marked C may have poor traction performance.
- **Temperature:** The temperature grades are A (the highest), B and C, representing the tire's resistance to the generation of heat and its ability to dissipate heat when tested under controlled conditions on a specified indoor laboratory test wheel.

13. **Maximum Permissible Inflation Pressure:** Indicates the tire manufacturers' maximum permissible pressure and/or the pressure at which the maximum load can be carried by the tire. This pressure is normally higher than the manufacturer's recommended cold inflation pressure which can be found on the Safety Compliance Certification Label or Tire Label which is located on the B-Pillar or the edge of the driver's door. The cold inflation pressure should never be set lower than the recommended pressure on the vehicle label.

The tire suppliers may have additional markings, notes or warnings such as standard load, radial tubeless, etc.

Tires, Wheels and Loading

Additional information contained on the tire sidewall for “LT” type tires

“LT” type tires have some additional information beyond those of “P” type tires; these differences are described below:

1. **LT:** Indicates a tire, designated by the Tire and Rim Association (T&RA), that is intended for service on light trucks.

2. **Load Range/Load Inflation Limits:** Indicates the tire’s load-carrying capabilities and its inflation limits.

3. **Maximum Load Dual lb. (kg) at psi (kPa) cold:** Indicates the maximum load and tire pressure when the tire is used as a dual; defined as four tires on the rear axle (a total of six or more tires on the vehicle).

4. **Maximum Load Single lb. (kg) at psi (kPa) cold:** Indicates the maximum load and tire pressure when the tire is used as a single; defined as two tires (total) on the rear axle.

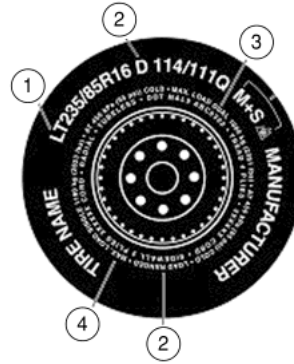

Tires, Wheels and Loading

Information on “T” type tires

“T” type tires have some additional information beyond those of “P” type tires; these differences are described below:

T145/80D16 is an example of a tire size.

Note: The temporary tire size for your vehicle may be different from this example.

1. **T:** Indicates a type of tire, designated by the Tire and Rim Association (T&RA), that is intended for temporary service on cars, SUVs, minivans and light trucks.

2. **145:** Indicates the nominal width of the tire in millimeters from sidewall edge to sidewall edge. In general, the larger the number, the wider the tire.

3. **80:** Indicates the aspect ratio which gives the tire’s ratio of height to width. Numbers of 70 or lower indicate a short sidewall.

4. **D:** Indicates a “diagonal” type tire.

R: Indicates a “radial” type tire.

5. **16:** Indicates the wheel or rim diameter in inches. If you change your wheel size, you will have to purchase new tires to match the new wheel diameter.

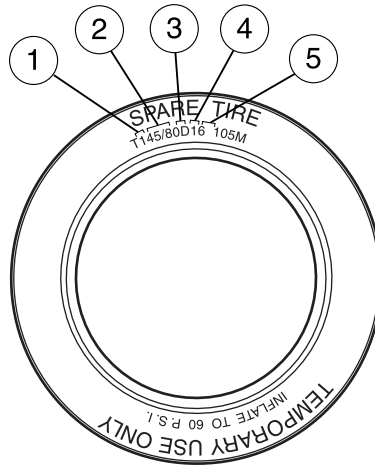

Location of the tire label

You will find a Tire Label containing tire inflation pressure by tire size and other important information located on the B-Pillar or the edge of the driver’s door. Refer to the payload description and graphic in the *Vehicle loading — with and without a trailer* section.

Tires, Wheels and Loading

TIRE PRESSURE MONITORING SYSTEM (TPMS) (IF EQUIPPED)

Each tire, including the spare (if provided), should be checked monthly when cold and inflated to the inflation pressure recommended by the vehicle manufacturer on the

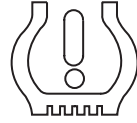

vehicle placard or tire inflation pressure label. (If your vehicle has tires of a different size than the size indicated on the vehicle placard or tire inflation pressure label, you should determine the proper tire inflation pressure for those tires.)

As an added safety feature, your vehicle has been equipped with a tire pressure monitoring system (TPMS) that illuminates a low tire pressure telltale when one or more of your tires is significantly under-inflated. Accordingly, when the low tire pressure telltale illuminates, you should stop and check your tires as soon as possible, and inflate them to the proper pressure. Driving on a significantly under-inflated tire causes the tire to overheat and can lead to tire failure. Under-inflation also reduces fuel efficiency and tire tread life, and may affect the vehicle's handling and stopping ability.

Please note that the TPMS is not a substitute for proper tire maintenance, and it is the driver's responsibility to maintain correct tire pressure, even if under-inflation has not reached the level to trigger illumination of the TPMS low tire pressure telltale.

The Tire Pressure Monitoring System complies with part 15 of the FCC rules and with RSS-210 of Industry Canada. Operation is subject to the following two conditions: (1) This device may not cause harmful interference, and (2) This device must accept any interference received, including interference that may cause undesired operation.

TPMS is not available on vehicles having different recommended tire pressures for the front and rear tires (e.g. Front Tires: 50 psi and Rear Tires: 60 psi).



The Tire Pressure Monitoring System is NOT a substitute for manually checking tire pressure. The tire pressure should be checked periodically (at least monthly) using a tire gauge, see *Inflating your tires* in this chapter. Failure to properly maintain your tire pressure could increase the risk of tire failure, loss of control, vehicle rollover and personal injury.

Tires, Wheels and Loading

Changing tires with TPMS

Each road tire is equipped with a tire pressure sensor fastened to the inside rim of the wheel. The pressure sensor is covered by the tire and is not visible unless the tire is removed. The pressure sensor is located opposite (180 degrees) from the valve stem. Care must be taken when changing the tire to avoid damaging the sensor. It is recommended that you always have your tires serviced by an authorized dealer.

The tire pressure should be checked periodically (at least monthly) using an accurate tire gauge, refer to *Inflating your tires* in this chapter.

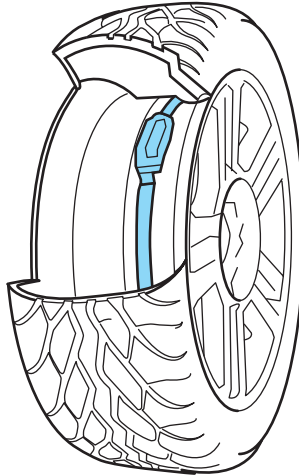

Understanding your Tire Pressure Monitoring System (TPMS)

The Tire Pressure Monitoring System measures pressure in your four road tires and sends the tire pressure readings to your vehicle. The Low Tire Warning Lamp will turn ON if the tire pressure is significantly low. Once the light is illuminated, your tires are under inflated and need to be inflated to the manufacturer's recommended tire pressure. Even if the light turns ON and a short time later turns OFF, your tire pressure still needs to be checked.

When your temporary spare tire is installed

When one of your road tires needs to be replaced with the temporary spare, the TPMS system will continue to identify an issue to remind you that the damaged road wheel/tire needs to be repaired and put back on your vehicle.

To restore the full functionality of the Tire Pressure Monitoring System, have the damaged road wheel/tire repaired and remounted on your vehicle. For additional information, refer to *Changing tires with TPMS* in this section.

Tires, Wheels and Loading

When you believe your system is not operating properly

The main function of the Tire Pressure Monitoring System is to warn you when your tires need air. It can also warn you in the event the system is no longer capable of functioning as intended. Please refer to the following chart for information concerning your Tire Pressure Monitoring System:

Low Tire Pressure Warning Light	Possible cause	Customer Action Required
Solid Warning Light	Tire(s) under-inflated	1. Check your tire pressure to ensure tires are properly inflated; refer to <i>Inflating your tires</i> in this chapter. 2. After inflating your tires to the manufacturer's recommended inflation pressure as shown on the Tire Label (located on the edge of driver's door or the B-Pillar), the vehicle must be driven for at least two minutes over 20 mph (32 km/h) before the light will turn OFF.
	Spare tire in use	Your temporary spare tire is in use. Repair the damaged road wheel/tire and reinstall it on the vehicle to restore system functionality. For a description on how the system functions, refer to <i>When your temporary spare tire is installed</i> in this section.
	TPMS malfunction	If your tires are properly inflated and your spare tire is not in use and the light remains ON, have the system inspected by your authorized dealer.

Tires, Wheels and Loading

Low Tire Pressure Warning Light	Possible cause	Customer Action Required
Flashing Warning Light	Spare tire in use	Your temporary spare tire is in use. Repair the damaged road wheel and re-mount it on the vehicle to restore system functionality. For a description of how the system functions under these conditions, refer to <i>When your temporary spare tire is installed</i> in this section.
	TPMS malfunction	If your tires are properly inflated and your spare tire is not in use and the TPMS warning light is still ON, have the system inspected by your authorized dealer.

When inflating your tires

When putting air into your tires (such as at a gas station or in your garage), the Tire Pressure Monitoring System may not respond immediately to the air added to your tires.

It may take up to two minutes of driving over 20 mph (32 km/h) for the light to turn OFF after you have filled your tires to the recommended inflation pressure.

How temperature affects your tire pressure

The Tire Pressure Monitoring System (TPMS) monitors tire pressure in each pneumatic tire. While driving in a normal manner, a typical passenger tire inflation pressure may increase approximately 2 to 4 psi (14 to 28 kPa) from a cold start situation. If the vehicle is stationary over night with the outside temperature significantly lower than the daytime temperature, the tire pressure may decrease approximately 3 psi (20.7 kPa) for a drop of 30° F (16.6° C) in ambient temperature. This lower pressure value may be detected by the TPMS as being significantly lower than the recommended inflation pressure and activate the TPMS warning for low tire pressure. If the low tire pressure warning light is ON, visually check each tire to verify that no tire is flat. If one or more tires are flat, repair as necessary. Check air pressure in the road tires. If

Tires, Wheels and Loading

any tire is under-inflated, carefully drive the vehicle to the nearest location where air can be added to the tires. Inflate all the tires to the recommended inflation pressure.

SNOW TIRES AND CHAINS



Snow tires must be the same size and grade as the tires you currently have on your vehicle.

The tires on your vehicle have all weather treads to provide traction in rain and snow. However, in some climates, you may need to use snow tires and chains. If you need to use chains, it is recommended that steel wheels (of the same size and specifications) be used, as chains may chip aluminum wheels.

Note: Do not place chains on the following tires sizes: P265/60R18, P275/65R18, LT275/65R18, P275/55R20, and P275/45R22.

Follow these guidelines when using snow tires and chains:

- Use only SAE Class S chains.
- Install chains securely, verifying that the chains do not touch any wiring, brake lines or fuel lines.
- Drive cautiously. If you hear the chains rub or bang against your vehicle, stop and re-tighten the chains. If this does not work, remove the chains to prevent damage to your vehicle.
- If possible, avoid fully loading your vehicle.
- Remove the tire chains when they are no longer needed. Do not use tire chains on dry roads.
- The suspension insulation and bumpers will help prevent vehicle damage. Do not remove these components from your vehicle when using snow tires and chains.

VEHICLE LOADING – WITH AND WITHOUT A TRAILER

This section will guide you in the proper loading of your vehicle and/or trailer, to keep your loaded vehicle weight within its design rating capability, with or without a trailer. Properly loading your vehicle will provide maximum return of vehicle design performance. Before loading your vehicle, familiarize yourself with the following terms for determining your vehicle's weight ratings, with or without a trailer, from the vehicle's Tire Label or Safety Compliance Certification Label:

Base Curb Weight – is the weight of the vehicle including a full tank of fuel and all standard equipment. It does not include passengers, cargo, or optional equipment.

Tires, Wheels and Loading

Vehicle Curb Weight – is the weight of your new vehicle when you picked it up from your authorized dealer plus any aftermarket equipment.

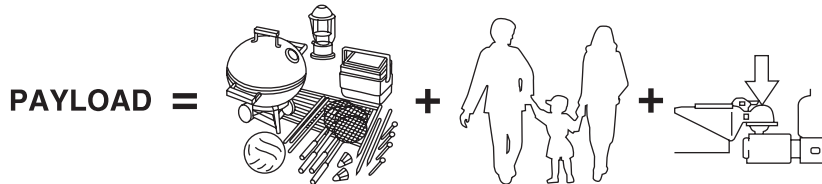

Payload – is the combined weight of cargo and passengers that the vehicle is carrying. The maximum payload for your vehicle can be found on the Tire Label on the B-Pillar or the edge of the driver's door (vehicles exported outside the US and Canada may not have a Tire Label). Look for **“THE COMBINED WEIGHT OF OCCUPANTS AND CARGO SHOULD NEVER EXCEED XXX kg OR XXX lb.”** for maximum payload. The payload listed on the Tire Label is the maximum payload for the vehicle as built by the assembly plant. If any aftermarket or authorized-dealer installed equipment has been installed on the vehicle, the weight of the equipment must be subtracted from the payload listed on the Tire Label in order to determine the new payload.

 The appropriate loading capacity of your vehicle can be limited either by volume capacity (how much space is available) or by payload capacity (how much weight the vehicle should carry). Once you have reached the maximum payload of your vehicle, do not add more cargo, even if there is space available. Overloading or improperly loading your vehicle can contribute to loss of vehicle control and vehicle rollover.

Tires, Wheels and Loading

Example only:

TIRE AND LOADING INFORMATION				
SEATING CAPACITY		TOTAL 5	FRONT 2	REAR 3
The combined weight of occupants and cargo should never exceed: XXX kg or XXX lbs.				
TIRE	SIZE	COLD TIRE PRESSURE	SEE OWNERS MANUAL FOR ADDITIONAL INFORMATION	
FRONT	LT225/75R 16.5E	200 KPA, 29 PSI		
REAR	LT225/75R 16.5E	200 KPA, 29 PSI		
SPARE	T145/80D16 P225/60R17	420 KPA, 60 PSI 200 KPA, 29 PSI		

TIRE AND LOAD INFORMATION				
SEATING CAPACITY		TOTAL XX	FRONT XX	REAR X
NOMBRE DE PLACES		TOTAL	AVANT	ARRIERE
The combined weight of occupants and cargo should never exceed: XXX kg. La charge du véhicule (occupants et bagages) ne doit jamais dépasser: XXX lbs.				
TIRE PNEUS	SIZE DIMENSIONS	COLD TIRE PRESSURE PRESSION A FROID	SEE OWNERS MANUAL FOR ADDITIONAL INFORMATION CONSULTER LE GUIDE DU PROPRIETAIRE POUR DE PLUS AMPLES RENSEIGNEMENTS	
FRONT/ AVANT	LT225/75R 16.5E	200 KPA, 29 PSI		
REAR/ ARRIERE	LT225/75R 16.5E	200 KPA, 29 PSI		
SPARE/ PNEU DE SECOURS	T145/80D16 P225/60R17	420 KPA, 60 PSI 200 KPA, 29 PSI		

CARGO

=



+

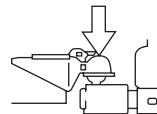

Cargo Weight – includes all weight added to the Base Curb Weight, including cargo and optional equipment. When towing, trailer tongue load or king pin weight is also part of cargo weight.

GAW (Gross Axle Weight) – is the total weight placed on each axle (front and rear) – including vehicle curb weight and all payload.

Tires, Wheels and Loading

GAWR (Gross Axle Weight Rating) – is the maximum allowable weight that can be carried by a single axle (front or rear). **These numbers are shown on the Safety Compliance Certification Label located on the B-Pillar or the edge of the driver's door. The total load on each axle must never exceed its GAWR.**

Note: For trailer towing information refer to *Trailer towing* found in this chapter or the *RV and Trailer Towing Guide* provided by your authorized dealer.

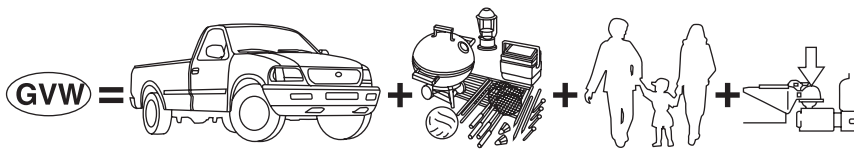

GVW (Gross Vehicle Weight) – is the Vehicle Curb Weight + cargo + passengers.

GVWR (Gross Vehicle Weight Rating) – is the maximum allowable weight of the fully loaded vehicle (including all options, equipment, passengers and cargo). **The GVWR is shown on the Safety Compliance Certification Label located on the B-Pillar or the edge of the driver's door. The GVW must never exceed the GVWR.**

MFD. BY FORD MOTOR CO.					
DATE: XX/XX	GVWR: XXXXLB/ XXXXKKG				
FRONT GAWR: XXXXL	REAR GAWR: XXXXLB				
XXXXKKG	WITH	XXXXKKG	WITH		
XXXX/XXXXXXX	TIRES	XXXX/XXXXXXX	TIRES		
XXXX.XX	RIMS	XXXX.XX	RIMS		
AT XXX kPa/XX	PSI COLD	AT XXX kPa/XX	PSI COLD		
THIS VEHICLE CONFORMS TO ALL APPLICABLE FEDERAL MOTOR VEHICLE SAFETY AND THEFT PREVENTION STANDARDS IN EFFECT ON THE DATE OF MANUFACTURE SHOWN ABOVE.					
VIN: XXXXXXXXXXXXXXXXX	XXXXX		XXXXX		
TYPE: XXX					
EXT PNT: XX	RC: XX	DSO:			
WB ¹ BRK ² INT TR ³ TP/PS ⁴ R ⁵ AXLE ⁶ TR SPR ⁷ XXXXX					
XXX X XX X XX X XX XXX					
XXXXXXXXXXXX XXX XXXX-XXXXXX-XX					



Exceeding the Safety Compliance Certification Label vehicle weight rating limits could result in substandard vehicle handling or performance, engine, transmission and/or structural damage, serious damage to the vehicle, loss of control and personal injury.

Tires, Wheels and Loading

$$\text{GCW} = \text{GVW} + \text{Trailer}$$

GCW (Gross Combined Weight) – is the weight of the loaded vehicle (GVW) plus the weight of the fully loaded trailer.

GCWR (Gross Combined Weight Rating) – is the maximum allowable weight of the vehicle and the loaded trailer – including all cargo and passengers – that the vehicle can handle without risking damage.

(Important: The towing vehicle's braking system is rated for operation at GVWR, not at GCWR.) Separate functional brakes should be used for safe control of towed vehicles and for trailers where the GCW of the towing vehicle plus the trailer exceed the GVWR of the towing vehicle.

The GCW must never exceed the GCWR.

Maximum Loaded Trailer Weight – is the highest possible weight of a fully loaded trailer the vehicle can tow. It assumes a vehicle with only mandatory options, no cargo (internal or external), a tongue load of 10–15% (conventional trailer) or king pin weight of 15–25% (fifth wheel trailer), and driver only (150 lb. [68 kg]). **Consult your authorized dealer (or the *RV and Trailer Towing Guide* provided by your authorized dealer) for more detailed information.**

Tongue Load or Fifth Wheel King Pin Weight – refers to the amount of the weight that a trailer pushes down on a trailer hitch.

Examples: For a 5,000 lb. (2,268 kg) conventional trailer, multiply 5,000 by 0.10 and 0.15 to obtain a proper tongue load range of 500 to 750 lb. (227 to 340 kg). For an 11,500 lb. (5,216 kg) fifth wheel trailer, multiply by 0.15 and 0.25 to obtain a proper king pin load range of 1,725 to 2,875 lb. (782 to 1,304 kg)



Do not exceed the GVWR or the GAWR specified on the Safety Compliance Certification Label.



Do not use replacement tires with lower load carrying capacities than the originals because they may lower the vehicle's GVWR and GAWR limitations. Replacement tires with a higher limit than the originals do not increase the GVWR and GAWR limitations.

Tires, Wheels and Loading



Exceeding any vehicle weight rating limitation could result in serious damage to the vehicle and/or personal injury.

Steps for determining the correct load limit:

1. Locate the statement “The combined weight of occupants and cargo should never exceed XXX kg or XXX lbs.” on your vehicle’s placard.
2. Determine the combined weight of the driver and passengers that will be riding in your vehicle.
3. Subtract the combined weight of the driver and passengers from XXX kg or XXX lbs.
4. The resulting figure equals the available amount of cargo and luggage load capacity. For example, if the “XXX” amount equals 1,400 lbs. and there will be five 150 lb. passengers in your vehicle, the amount of available cargo and luggage load capacity is 650 lbs. ($1400 - 750 (5 \times 150) = 650$ lb.). In metric units ($635 - 340 (5 \times 68) = 295$ kg.)
5. Determine the combined weight of luggage and cargo being loaded on the vehicle. That weight may not safely exceed the available cargo and luggage load capacity calculated in Step 4.
6. If your vehicle will be towing a trailer, load from your trailer will be transferred to your vehicle. Consult this manual to determine how this reduces the available cargo and luggage load capacity of your vehicle.

The following gives you a few examples on how to calculate the available amount of cargo and luggage load capacity:

- Another example for your vehicle with 1400 lb. (635 kg) of cargo and luggage capacity. You decide to go golfing. Is there enough load capacity to carry you, 4 of your friends and all the golf bags? You and four friends average 220 lb. (99 kg) each and the golf bags weigh approximately 30 lb. (13.5 kg) each. The calculation would be: $1400 - (5 \times 220) - (5 \times 30) = 1400 - 1100 - 150 = 150$ lb. Yes, you have enough load capacity in your vehicle to transport four friends and your golf bags. In metric units, the calculation would be: $635 \text{ kg} - (5 \times 99 \text{ kg}) - (5 \times 13.5 \text{ kg}) = 635 - 495 - 67.5 = 72.5$ kg.
- A final example for your vehicle with 1400 lb. (635 kg) of cargo and luggage capacity. You and one of your friends decide to pick up cement from the local home improvement store to finish that patio you have been planning for the past 2 years. Measuring the inside of the vehicle with the rear seat folded down, you have room for 12-100 lb. (45 kg) bags of cement. Do you have enough load capacity to

Tires, Wheels and Loading

transport the cement to your home? If you and your friend each weigh 220 lb. (99 kg), the calculation would be: $1400 - (2 \times 220) - (12 \times 100) = 1400 - 440 - 1200 = -240$ lb. No, you do not have enough cargo capacity to carry that much weight. In metric units, the calculation would be: $635 \text{ kg} - (2 \times 99 \text{ kg}) - (12 \times 45 \text{ kg}) = 635 - 198 - 540 = -103$ kg. You will need to reduce the load weight by at least 240 lb. (104 kg). If you remove 3-100 lb. (45 kg) cement bags, then the load calculation would be:

$1400 - (2 \times 220) - (9 \times 100) = 1400 - 440 - 900 = 60$ lb. Now you have the load capacity to transport the cement and your friend home. In metric units, the calculation would be: $635 \text{ kg} - (2 \times 99 \text{ kg}) - (9 \times 45 \text{ kg}) = 635 - 198 - 405 = 32$ kg.

The above calculations also assume that the loads are positioned in your vehicle in a manner that does not overload the Front or the Rear Gross Axle Weight Rating specified for your vehicle on the Safety Compliance Certification Label found on the edge of the driver's door.

Special loading instructions for owners of pickup trucks and utility-type vehicles



For important information regarding safe operation of this type of vehicle, see the *Preparing to drive your vehicle* section in the *Driving* chapter of this *Owner's Guide*.



Loaded vehicles may handle differently than unloaded vehicles. Extra precautions, such as slower speeds and increased stopping distance, should be taken when driving a heavily loaded vehicle.

Your vehicle can haul more cargo and people than most passenger cars. Depending upon the type and placement of the load, hauling cargo and people may raise the center of gravity of the vehicle.

TRAILER TOWING

Your vehicle may tow a class I, II, III or IV trailer provided the maximum trailer weight is less than or equal to the maximum trailer weight listed for your engine and rear axle ratio on the following charts.

If your vehicle is not equipped with a heavy-duty trailer towing package, the maximum weight your vehicle can tow is limited to 5,000 lb. (2,268 kg)

Your vehicle's load capacity is designated by weight, not by volume, so you cannot necessarily use all available space when loading a vehicle.

Tires, Wheels and Loading

Towing a trailer places an additional load on your vehicle's engine, transmission, axle, brakes, tires and suspension. Inspect these components carefully periodically during, and after any towing operation.

Exceeding the maximum GCWR could result in extensive damage to your vehicle and personal injury.



Do not exceed the GVWR or the GAWR specified on the certification label.



Towing trailers beyond the maximum recommended gross trailer weight exceeds the limit of the vehicle and could result in engine damage, transmission damage, structural damage, loss of vehicle control, vehicle rollover and personal injury.

Regular Cab 4x2 (126" wheelbase)			
Engine	Rear axle ratio	Maximum GCWR-lb. (kg)	Maximum trailer weight-lb. (kg)
4.2L (with manual transmission)	3.31	7200 (3266)	2400 (1089)
	3.55	8500 (3856)	3700 (1678)
4.2L (with automatic transmission)	3.55	10000 (4536)	5100 (2313)
	3.73	10500 (4763)	5600 (2540)
4.6L	3.55	11500 (5216)	6600 (2993)
4.6L	3.73	12000 (5443)	7100 (3220)
5.4L	3.55	13000 (5897)	8000 (3628)
5.4L	3.73	13500 (6123)	8500 (3855)
Regular Cab 4x2 (144.5" wheelbase)			
Engine	Rear axle ratio	Maximum GCWR-lb. (kg)	Maximum trailer weight-lb. (kg)
4.2L (with manual transmission)	3.31	7200 (3266)	2300 (1043)
	3.55	8500 (3856)	3600 (1633)

Tires, Wheels and Loading

Regular Cab 4x2 (144.5" wheelbase)			
Engine	Rear axle ratio	Maximum GCWR-lb. (kg)	Maximum trailer weight-lb. (kg)
4.2L (with automatic transmission)	3.55	10000 (4536)	5000 (2268)
	3.73	10500 (4763)	5500 (2495)
4.6L	3.55	11700 (5307)	6700 (3039)
4.6L	3.73	12200 (5534)	7200 (3266)
5.4L	3.55	14000 (6350)	8800 (3992)
5.4L	3.73	15000 (6804)	9800 (4445)
5.4L Heavy Duty	4.10	15300 (6940)	10500 (4763)

Regular Cab 4x4 (126" wheelbase)			
Engine	Rear axle ratio	Maximum GCWR-lb. (kg)	Maximum trailer weight-lb. (kg)
4.6L	3.55	11500 (5216)	6300 (2857)
4.6L	3.73	12000 (5443)	6800 (3084)
5.4L (with 17" tires)	3.55	13000 (5897)	7700 (3492)
5.4L (with 18" tires)	3.55	12500 (5670)	7200 (3266)
5.4L (with 17" tires)	3.73	13500 (6123)	8200 (3719)
5.4L (with 18" tires)	3.73	13000 (5897)	7700 (3492)

Regular Cab 4x4 (144.5" wheelbase)			
Engine	Rear axle ratio	Maximum GCWR-lb. (kg)	Maximum trailer weight-lb. (kg)
4.6L	3.55	11700 (5307)	6400 (2903)
4.6L	3.73	12200 (5534)	6900 (3130)

Tires, Wheels and Loading

Regular Cab 4x4 (144.5" wheelbase)			
Engine	Rear axle ratio	Maximum GCWR-lb. (kg)	Maximum trailer weight-lb. (kg)
5.4L (with 17" tires)	3.55	14000 (6350)	8500 (3856)
5.4L (with 18" or 20" tires)	3.55	13500 (6123)	8000 (3629)
5.4L (with 17" tires)	3.73	15000 (6804)	9500 (4309)
5.4L (with 18" or 20" tires)	3.73	14500 (6577)	9000 (4082)
5.4L Heavy Duty	4.10	15300 (6940)	9500 (4309)
SuperCab 4x2 (132.5" wheelbase)			
Engine	Rear axle ratio	Maximum GCWR-lb. (kg)	Maximum trailer weight-lb. (kg)
4.6L (with 17" tires)	3.55	11500 (5216)	6300 (2858)
4.6L (with 18" tires)	3.55	11000 (4989)	5800 (2630)
4.6L (with 17" tires)	3.73	12000 (5443)	6800 (3084)
4.6L (with 18" tires)	3.73	11500 (5216)	6300 (2858)
5.4L (with 17" tires)	3.55	13000 (5897)	7600 (3447)
5.4L (with 18" tires)	3.55	12500 (5670)	7100 (3221)
5.4L (with 17" tires)	3.73	13500 (6123)	8100 (3674)
5.4L (with 18" tires)	3.73	13000 (5897)	7600 (3447)

Tires, Wheels and Loading

SuperCab 4x2 (144.5" wheelbase)			
Engine	Rear axle ratio	Maximum GCWR-lb. (kg)	Maximum trailer weight-lb. (kg)
4.6L (with 17" tires)	3.55	11700 (5307)	6500 (2948)
4.6L (with 18" tires)	3.55	11200 (5081)	6000 (2722)
4.6L (with 17" tires)	3.73	12200 (5534)	7000 (3175)
4.6L (with 18" tires)	3.73	11700 (5307)	6500 (2948)
5.4L (with 17" tires)	3.55	14000 (6350)	8600 (3901)
5.4L (with 18" or 20" tires)	3.55	13500 (6123)	8100 (3674)
5.4L (with 17" tires)	3.73	15000 (6804)	9500 (4309)
5.4L (with 18" or 20" tires)	3.73	14500 (6577)	9000 (4082)

SuperCab 4x2 (163" wheelbase)			
Engine	Rear axle ratio	Maximum GCWR-kg (lb.)	Maximum trailer weight-kg (lb.)
5.4L Heavy Duty	4.10	15300 (6940)	9500 (4309)

SuperCab 4x4 (132.5" wheelbase)			
Engine	Rear axle ratio	Maximum GCWR-lb. (kg)	Maximum trailer weight-lb. (kg)
4.6L (with 17" tires)	3.55	11500 (5216)	6000 (2721)
4.6L (with 18" tires)	3.55	11000 (4990)	5500 (2494)

Tires, Wheels and Loading

SuperCab 4x4 (132.5" wheelbase)			
Engine	Rear axle ratio	Maximum GCWR-lb. (kg)	Maximum trailer weight-lb. (kg)
4.6L (with 17" tires)	3.73	12000 (5443)	6500 (2948)
4.6L (with 18" tires)	3.73	11500 (5216)	6000 (2721)
5.4L (with 17" tires)	3.55	13000 (5897)	7300 (3311)
5.4L (with 18" tires)	3.55	12500 (5670)	6800 (3084)
5.4L (with 17" tires)	3.73	13500 (6123)	7800 (3538)
5.4L (with 18" tires)	3.73	13000 (5897)	7300 (3311)

SuperCab 4x4 (144.5" wheelbase)			
Engine	Rear axle ratio	Maximum GCWR-lb. (kg)	Maximum trailer weight-lb. (kg)
4.6L (with 17" tires)	3.55	11700 (5307)	6200 (2812)
4.6L (with 18" tires)	3.55	11200 (5080)	5700 (2585)
4.6L (with 17" tires)	3.73	12200 (5534)	6700 (3039)
4.6L (with 18" tires)	3.73	11700 (5307)	6200 (2812)
5.4L (with 17" tires)	3.55	14000 (6350)	8300 (3765)
5.4L (with 18" or 20" tires)	3.55	13500 (6123)	7800 (3538)
5.4L (with 17" tires)	3.73	15000 (6804)	9300 (4218)

Tires, Wheels and Loading

SuperCab 4x4 (144.5" wheelbase)			
Engine	Rear axle ratio	Maximum GCWR-lb. (kg)	Maximum trailer weight-lb. (kg)
5.4L (with 18" or 20" tires)	3.73	14500 (6577)	8800 (3992)
SuperCab 4x4 (163" wheelbase)			
Engine	Rear axle ratio	Maximum GCWR-lb. (kg)	Maximum trailer weight-lb. (kg)
5.4L Heavy Duty	4.10	15300 (6940)	9300 (4218)
Crew Cab 4x2 (138.5" wheelbase)			
Engine	Rear axle ratio	Maximum GCWR-lb. (kg)	Maximum trailer weight-lb. (kg)
4.6L (with 17" tires)	3.55	11700 (5307)	6400 (2903)
4.6L (with 18" or 20" tires)	3.55	11200 (5080)	5900 (2676)
4.6L (with 17" tires)	3.73	12200 (5534)	6900 (3130)
4.6L (with 18" or 20" tires)	3.73	11700 (5307)	6400 (2903)
5.4L (with 17" tires)	3.55	14000 (6350)	8500 (3856)
5.4L (with 18" or 20" tires)	3.55	13500 (6123)	8000 (3629)
5.4L (with 17" tires)	3.73	15000 (6804)	9500 (4309)
5.4L (with 18" or 20" tires)	3.73	14500 (6577)	9000 (4082)

Tires, Wheels and Loading

Crew Cab 4x2 (138.5" wheelbase) Harley-Davidson Version			
Engine	Rear axle ratio	Maximum GCWR-lb. (kg)	Maximum trailer weight-lb. (kg)
5.4L	3.73	11000 (4990)	5300 (2404)

Crew Cab 4x4 (138.5" wheelbase)			
Engine	Rear axle ratio	Maximum GCWR-lb. (kg)	Maximum trailer weight-lb. (kg)
4.6L (with 17" tires)	3.73	12200 (5534)	6600 (2994)
4.6L (with 18" tires)	3.73	11700 (5307)	6100 (2767)
5.4L (with 17" tires)	3.55	14000 (6350)	8200 (3719)
5.4L (with 18" or 20" tires)	3.55	13500 (6123)	7700 (3493)
5.4L (with 17" tires)	3.73	15000 (6804)	9200 (4173)
5.4L (with 18" or 20" tires)	3.73	14500 (6577)	8700 (3946)

Crew Cab 4x4 (138.5" wheelbase) Harley-Davidson Version			
Engine	Rear axle ratio	Maximum GCWR-lb. (kg)	Maximum trailer weight-lb. (kg)
5.4L	3.73	11000 (4990)	5100 (2313)

Crew Cab 4x2 (150.5" wheelbase)			
Engine	Rear axle ratio	Maximum GCWR-lb. (kg)	Maximum trailer weight-lb. (kg)
4.6L (with 17" tires)	3.55	11700 (5307)	6200 (2812)

Tires, Wheels and Loading

Crew Cab 4x2 (150.5" wheelbase)			
Engine	Rear axle ratio	Maximum GCWR-lb. (kg)	Maximum trailer weight-lb. (kg)
4.6L (with 18" or 20" tires)	3.55	11200 (5080)	5700 (2585)
4.6L (with 17" tires)	3.73	12200 (5534)	6700 (3039)
4.6L (with 18" or 20" tires)	3.73	11700 (5307)	6200 (2812)
5.4L (with 17" tires)	3.55	14000 (6350)	8400 (3810)
5.4L (with 18" or 20" tires)	3.55	13500 (6123)	7900 (3583)
5.4L (with 17" tires)	3.73	15000 (6804)	9400 (4263)
5.4L (with 18" or 20" tires)	3.73	14500 (6577)	8900 (4036)

Crew Cab 4x4 (150.5" wheelbase)			
Engine	Rear axle ratio	Maximum GCWR-lb. (kg)	Maximum trailer weight-lb. (kg)
4.6L (with 17" tires)	3.73	12200 (5534)	6500 (2948)
4.6L (with 18" tires)	3.73	11700 (5307)	6000 (2722)
5.4L (with 17" tires)	3.55	14000 (6350)	8100 (3674)
5.4L (with 18" or 20" tires)	3.55	13500 (6123)	7600 (3447)
5.4L (with 17" tires)	3.73	15000 (6804)	9100 (4127)
5.4L (with 18" or 20" tires)	3.73	14500 (6577)	8600 (3900)

Tires, Wheels and Loading

Trailer frontal area considerations:

- Not to exceed towing vehicle frontal area without Class IV trailer towing package
- Not to exceed 60 square feet (5.52 square meters) with Class IV trailer towing package

Preparing to tow

Use the proper equipment for towing a trailer and make sure it is properly attached to your vehicle. See your authorized dealer or a reliable trailer dealer if you require assistance.

Hitches

Do not use hitches that clamp onto the vehicle's bumper or attach to the axle. You must distribute the load in your trailer so that 10%–15% of the total weight of the trailer is on the tongue.

Weight distributing hitch

When hooking up a trailer using a load equalizing hitch, always use the following procedure:

1. Park the unloaded vehicle on a level surface. With the ignition on and all doors closed, allow the vehicle to stand for several minutes so that it can level.
2. Measure the height of a reference point on the front and rear bumpers at the center of the vehicle.
3. Attach the trailer to the vehicle and adjust the hitch equalizers so that the front bumper height is within $\frac{1}{2}$ " (13 mm) of the reference point. After proper adjustment, the rear bumper should be no higher than in Step 2.

Note: Adjusting a weight distributing hitch so the rear bumper of the vehicle is higher than it was unloaded will defeat the function of the weight distributing hitch and may cause unpredictable handling.

Safety chains

Always connect the trailer's safety chains to the frame or hook retainers of the vehicle hitch. To connect the trailer's safety chains, cross the chains under the trailer tongue and allow slack for turning corners.

If you use a rental trailer, follow the instructions that the rental agency gives to you.

Do not attach safety chains to the bumper.

Tires, Wheels and Loading

Trailer brakes

Electric brakes and manual, automatic or surge-type trailer brakes are safe if installed properly and adjusted to the manufacturer's specifications. The trailer brakes must meet local and Federal regulations.



Do not connect a trailer's hydraulic brake system directly to your vehicle's brake system. Your vehicle may not have enough braking power and your chances of having a collision greatly increase.

The braking system of the tow vehicle is rated for operation at the GVWR not GCWR.

Trailer lamps

Trailer lamps are required on most towed vehicles. Make sure all running lights, brake lights, turn signals and hazard lights are working. See your authorized dealer or trailer rental agency for proper instructions and equipment for hooking up trailer lamps.

Using a step bumper (if equipped)

The rear bumper is equipped with an integral hitch and only requires a ball with a one inch (25.4 mm) shank diameter. The bumper has a 5,000 lb. (2,270 kg) trailer weight and 500 lb. (227 kg) tongue weight capacity.

If it is necessary to relocate the trailer hitch ball position, a frame-mounted trailer hitch must be installed.

Driving while you tow

When towing a trailer:

- Keep your speed no faster than 70 mph (112 km/h) during the first 500 miles (800 km) of towing a trailer, and don't make full throttle starts.
- Turn off the speed control. The speed control may shut off automatically when you are towing on long, steep grades.
- Consult your local motor vehicle speed regulations for towing a trailer.
- To eliminate excessive shifting, use a lower gear. This will also assist in transmission cooling. (For additional information, refer to *Understanding the gearshift positions of the 4-speed automatic transmission* in the *Driving* chapter.)
- Anticipate stops and brake gradually.

204

Tires, Wheels and Loading

- Do not exceed the GCWR rating or transmission damage may occur.

Servicing after towing

If you tow a trailer for long distances, your vehicle will require more frequent service intervals. Refer to your *Scheduled Maintenance Information* for more information.

Trailer towing tips

- Practice turning, stopping and backing up before starting on a trip to get the feel of the vehicle trailer combination. When turning, make wider turns so the trailer wheels will clear curbs and other obstacles.
- Allow more distance for stopping with a trailer attached.
- The trailer tongue weight should be 10–15% of the loaded trailer weight.
- If you will be towing a trailer frequently in hot weather, hilly conditions, at GCWR, or any combination of these factors, consider refilling your rear axle with synthetic gear lube if not already so equipped. Refer to the *Maintenance and specifications* chapter for the lubricant specification. Remember that regardless of the rear axle lube used, do not tow a trailer for the first 500 miles (800 km) of a new vehicle, and that the first 500 miles (800 km) of towing be done at no faster than 70 mph (112 km/h) with no full throttle starts.
- After you have traveled 50 miles (80 km), thoroughly check your hitch, electrical connections and trailer wheel lug nuts.
- To aid in engine/transmission cooling and A/C efficiency during hot weather while stopped in traffic, place the gearshift lever in P (Park) (automatic transmission) or N (Neutral) (manual transmissions).
- Vehicles with trailers should not be parked on a grade. If you must park on a grade, place wheel chocks under the trailer's wheels.

Launching or retrieving a boat

Disconnect the wiring to the trailer before backing the trailer into the water. Reconnect the wiring to the trailer after the trailer is removed from the water.

When backing down a ramp during boat launching or retrieval:

- do not allow the static water level to rise above the bottom edge of the rear bumper.
- do not allow waves to break higher than 6 inches (15 cm) above the bottom edge of the rear bumper.

Tires, Wheels and Loading

Exceeding these limits may allow water to enter vehicle components:

- causing internal damage to the components.
- affecting driveability, emissions and reliability.

Replace the rear axle lubricant any time the axle has been submerged in water. Rear axle lubricant quantities are not to be checked or changed unless a leak is suspected or repair required.

RECREATIONAL TOWING

Follow these guidelines if you have a need for recreational towing. An example of recreational towing would be towing your vehicle behind a motorhome. These guidelines are designed to ensure that your transmission is not damaged.

4x4 vehicles equipped with manual-shift transfer case:

- Release the parking brake.
- Turn the key in the ignition to the OFF position.
- Place the transmission in N (Neutral).
- Place the transfer case lever in N (Neutral).
- Do not exceed 55 mph (88 km/h) vehicle speed.
- The maximum recommended distance is unlimited.
- The vehicle must be towed in the forward position to ensure no damage is done to the internal transfer case components.

The transfer case N (Neutral) position overrides the transmission and puts the vehicle in neutral regardless of transmission gearshift lever position. The vehicle can move forward or backward.

This position should only be used when towing the vehicle.



Do not leave the vehicle unattended with the transfer case in the N (Neutral) position. Always set the parking brake fully and turn off the ignition when leaving the vehicle.

After reaching the destination, you must place your vehicle's 4x4 gearshift lever in gear (2H, 4H or 4L).

Tires, Wheels and Loading

Vehicles equipped with automatic transmission and 4x4 vehicles equipped with an electronic-shift transfer case:

- Release the parking brake.
- Turn the key in the ignition to the OFF position.
- Place the transmission in N (Neutral).
- Do not exceed a distance of 50 miles (80 km).
- Do not exceed 35 mph (56 km/h) vehicle speed.
- The vehicle must be towed in the forward position to ensure no damage is done to the internal transfer case components.

If a distance of 50 miles (80 km) or a speed of 35 mph (56 km/h) must be exceeded, you must disconnect the front (4x4 only) and rear driveshafts. Ford recommends the driveshafts be removed/installed only by a qualified technician at an authorized dealer. See your authorized dealer for driveshaft removal/installation.

Improper removal/installation of the driveshaft can cause transmission fluid or transfer case fluid loss, damage to the driveshaft and internal transmission and transfer case components.

Driving

STARTING

Positions of the ignition

1. OFF/LOCK, locks the steering wheel, automatic transmission gearshift lever and allows key removal.

Note: The ignition key cannot be removed from the ignition unless the gearshift lever is securely latched in P (Park).

2. ACCESSORY, allows the electrical accessories such as the radio to operate while the engine is not running.

3. ON, all electrical circuits operational. Warning lights illuminated. Key position when driving.

4. START, cranks the engine. Release the key as soon as the engine starts.

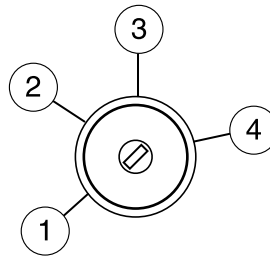

Preparing to start your vehicle

Engine starting is controlled by the powertrain control system. This system meets all Canadian Interference-Causing Equipment standard requirements regulating the impulse electrical field strength of radio noise.

When starting a fuel-injected engine, don't press the accelerator before or during starting. Only use the accelerator when you have difficulty starting the engine. For more information on starting the vehicle, refer to *Starting the engine* in this chapter.





Extended idling at high engine speeds can produce very high temperatures in the engine and exhaust system, creating the risk of fire or other damage.



Do not park, idle, or drive your vehicle in dry grass or other dry ground cover. The emission system heats up the engine compartment and exhaust system, which can start a fire.

Driving

 Do not start your vehicle in a closed garage or in other enclosed areas. Exhaust fumes can be toxic. Always open the garage door before you start the engine. See *Guarding against exhaust fumes* in this chapter for more instructions.

 If you smell exhaust fumes inside your vehicle, have your dealer inspect your vehicle immediately. Do not drive if you smell exhaust fumes.

Important safety precautions

A computer system controls the engine's idle revolutions per minute (RPM). When the engine starts, the idle RPM runs higher than normal in order to warm the engine. If the engine idle speed does not slow down automatically, have the vehicle checked. If the vehicle is operated in a heavy snow storm or blowing snow conditions, the engine air induction may become partially clogged with snow and/or ice. If this occurs the engine may experience a significant reduction in power output. At the earliest opportunity, clear all snow and/or ice away from the air induction inlet. Do not allow the vehicle to idle for more than 10 minutes at the higher engine RPM.

Before starting the vehicle:

1. Make sure all vehicle occupants have buckled their safety belts. For more information on safety belts and their proper usage, refer to the *Seating and Safety Restraints* chapter.
2. Make sure the headlamps and vehicle accessories are off.

If starting a vehicle with an automatic transmission:

- Make sure the gearshift is in P (Park).

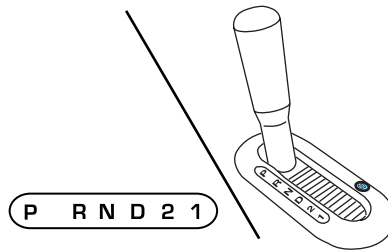

Driving

- Make sure the parking brake is set.

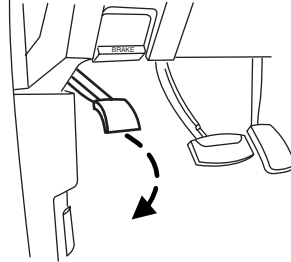

If starting a vehicle with a manual transmission:

- Make sure the parking brake is set.
- Push the clutch pedal to the floor

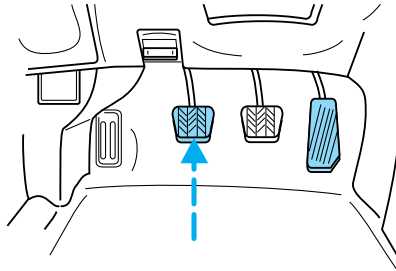

3. Turn the key to 3 (ON) without turning the key to 4 (START).

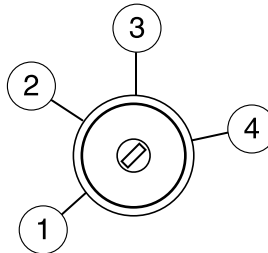

Some warning lights will briefly illuminate. See *Warning lights and chimes* in the *Instrument Cluster* chapter for more information regarding the warning lights.

Starting the engine

1. Turn the key to 3 (ON) without turning the key to 4 (START). If there is difficulty in turning the key, rotate the steering wheel until the key turns freely.
2. Turn the key to 4 (START), then release the key as soon as the engine starts.

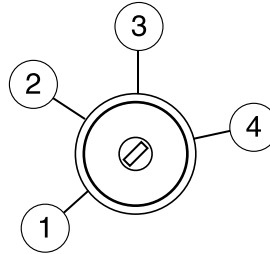

Note: If the engine does not start within five seconds on the first try, turn the key to OFF, wait 10 seconds and try again. If the engine still fails to start, press and hold the accelerator to the floor and try again; this will allow the engine to crank with the fuel shut off in case the engine is flooded with fuel.

Cold weather starting (flexible fuel vehicles only)

As the outside temperature approaches freezing, ethanol fuel distributors should supply winter grade ethanol (same as with unleaded gasoline). If summer grade ethanol is used in cold weather conditions, you may experience increased cranking times, rough idle or hesitation until the engine has warmed up. Consult your fuel distributor for the availability of winter grade ethanol.

Do not crank the engine for more than 30 seconds at a time as starter damage may occur. If the engine fails to start, turn the key to OFF and wait 30 seconds before trying again.

Do not use starting fluid such as ether in the air intake system. Such fluid could cause immediate explosive damage to the engine and possible personal injury.

If you should experience cold weather starting problems on E₈₅ ethanol, and neither an alternative brand of E₈₅ ethanol nor an engine block heater is available, the addition of unleaded gasoline to your tank will improve cold starting performance. Your vehicle is designed to operate on E₈₅ ethanol alone, unleaded gasoline alone, or any mixture of the two.

See *Choosing the right fuel* in the *Maintenance and Specifications* chapter for more information on ethanol.

Driving

If the engine fails to start using the preceding instructions (flexible fuel vehicles only)

1. Press and hold down the accelerator 1/3 to 1/2 way to floor, then crank the engine.
2. When the engine starts, release the key, then gradually release the accelerator pedal as the engine speeds up. If the engine still fails to start, repeat Step 1.

Guarding against exhaust fumes

Carbon monoxide is present in exhaust fumes. Take precautions to avoid its dangerous effects.



If you smell exhaust fumes inside your vehicle, have your dealer inspect your vehicle immediately. Do not drive if you smell exhaust fumes.

Important ventilating information

If the engine is idling while the vehicle is stopped for a long period of time, open the windows at least one inch (2.5 cm) or adjust the heating or air conditioning to bring in fresh air.

ENGINE BLOCK HEATER (IF EQUIPPED)

An engine block heater warms the engine coolant which aids in starting and heater/defroster performance. Use of an engine block heater is strongly recommended if you live in a region where temperatures reach -10°F (-23°C) or below. For best results, plug the heater in at least three hours before starting the vehicle. The heater can be plugged in the night before starting the vehicle.



To reduce the risk of electrical shock, do not use your heater with ungrounded electrical systems or two-pronged (cheater) adapters.

BRAKES

Occasional brake noise is normal. If a metal-to-metal, continuous grinding or continuous squeal sound is present, the brake linings may be worn-out and should be inspected by an authorized dealer. If the vehicle has continuous vibration or shudder in the steering wheel while braking, the vehicle should be inspected by an authorized dealer.

212

Refer to *Brake system warning light* in the *Instrument Cluster* chapter for information on the brake system warning light.

Base, Base with Tachometer and Family Carrier instrument cluster



Mid, Luxury and Harley-Davidson instrument cluster



Four-wheel anti-lock brake system (ABS)

Your vehicle is equipped with an Anti-lock Braking System (ABS). This system helps you maintain steering control during emergency stops by keeping the brakes from locking. Noise from the ABS pump motor and brake pedal pulsation may be observed during ABS braking and the brake pedal may suddenly travel a little farther as soon as ABS braking is done and normal brake operation resumes. These are normal characteristics of the ABS and should be no reason for concern.

Using ABS

When hard braking is required, apply continuous force on the brake pedal; do not pump the brake pedal since this will reduce the effectiveness of the ABS and will increase your vehicle's stopping distance. The ABS will be activated immediately, allowing you to retain steering control during hard braking and on slippery surfaces. However, the ABS does not decrease stopping distance.

ABS warning lamp

The ABS lamp in the instrument cluster momentarily illuminates when the ignition is turned on. If the light does not illuminate during start up, remains on or flashes, the ABS may be disabled and may need to be serviced.



Even when the ABS is disabled, normal braking is still effective. (If your BRAKE warning lamp illuminates with the parking brake released, have your brake system serviced immediately.)

Driving

Base, Base with Tachometer and Family Carrier instrument cluster

(!)
BRAKE

Mid, Luxury and Harley-Davidson instrument cluster

(!) (P)
BRAKE

Parking brake

To set the parking brake (1), press the parking brake pedal down until the pedal stops.

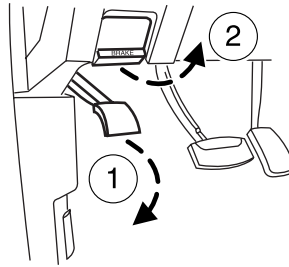

The BRAKE warning lamp will illuminate and will remain illuminated until the parking brake is released.

Base, Base with Tachometer and Family Carrier instrument cluster

(!)
BRAKE

Mid, Luxury and Harley-Davidson instrument cluster

(!) (P)
BRAKE

To release, pull the lever (2).



Always set the parking brake fully and make sure that the gearshift is securely latched in P (Park) (automatic transmission) or in 1 (First) (manual transmission).

TRACTION CONTROL™ (IF EQUIPPED)

Your vehicle may be equipped with a Traction Control™ system. This system helps you maintain the stability and steerability of your vehicle, especially on slippery road surfaces such as snow- or ice-covered roads and gravel roads. The system will allow your vehicle to make better use of available traction in these conditions.

During Traction Control™ operation, the traction control active light will illuminate and the engine will not “rev-up” when you push further on the accelerator. This is normal system behavior and should be no reason for concern.



Aggressive driving in any road conditions can cause you to lose control of your vehicle increasing the risk of severe personal injury or property damage. The occurrence of a Traction Control™ event is an indication that at least some of the tires have exceeded their ability to grip the road; this may lead to an increased risk of loss of vehicle control, vehicle rollover, personal injury and death. If you experience a severe road event, SLOW DOWN.

The Traction Control™ switch, located on the center console, has an indicator light that illuminates when the system is off. The Traction Control™ system will automatically turn on every time the ignition is turned off and on. The Traction Control™ system should normally be left on.

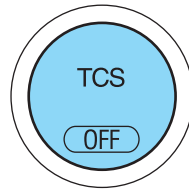

If you should become stuck in snow or ice or on a very slippery road surface, try switching the Traction Control™ system off. This may allow excess wheel spin to “dig” the vehicle out and enable a successful “rocking” maneuver.

If a system fault is detected, the traction control active light will illuminate, the Traction Control™ button will not turn the system on or off and your vehicle should be serviced by an authorized dealer.

Driving

STEERING

To help prevent damage to the power steering system:

- Never hold the steering wheel at its furthest turning points (until it stops) for more than a few seconds when the engine is running.
- Do not operate the vehicle with a low power steering fluid level (below the MIN mark on the reservoir).
- Some noise is normal during operation. If the noise is excessive, check for a low power steering fluid level before seeking service by your authorized dealer.
- Heavy or uneven steering efforts may be caused by a low power steering fluid level. Check for a low power steering fluid level before seeking service by your authorized dealer.
- Do not fill the power steering fluid reservoir above the MAX mark on the reservoir, as this may result in leaks from the reservoir.

If the power steering system breaks down (or if the engine is turned off), you can steer the vehicle manually, but it takes more effort.

If the steering wanders or pulls, check for:

- an improperly inflated tire
- uneven tire wear
- loose or worn suspension components
- loose or worn steering components
- improper steering alignment

A high crown in the road or high crosswinds may also make the steering seem to wander/pull.

TRACTION-LOK AXLE (IF EQUIPPED)

This axle provides added traction on slippery surfaces, particularly when one wheel is on a poor traction surface. Under normal conditions, the Traction-Lok axle functions like a standard rear axle. The axle may exhibit a slight noise or vibration in tight turns with low vehicle speed. This is normal behavior and indicates the axle is working.

Driving

PREPARING TO DRIVE



Utility vehicles have a significantly higher rollover rate than other types of vehicles.



In a rollover crash, an unbelted person is significantly more likely to die than a person wearing a seat belt.

Your vehicle has larger tires and increased ground clearance, giving the vehicle a higher center of gravity than a passenger car.



Vehicles with a higher center of gravity such as utility and four-wheel drive vehicles handle differently than vehicles with a lower center of gravity. Utility and four-wheel drive vehicles are **not** designed for cornering at speeds as high as passenger cars any more than low-slung sports cars are designed to perform satisfactorily under off-road conditions. Avoid sharp turns, excessive speed and abrupt maneuvers in these vehicles. Failure to drive cautiously could result in an increased risk of loss of vehicle control, vehicle rollover, personal injury and death.



Loaded vehicles, with a higher center of gravity, may handle differently than unloaded vehicles. Extra precautions such as slower speeds and increased stopping distance should be taken when driving a heavily loaded vehicle.

AUTOMATIC TRANSMISSION OPERATION

Brake-shift interlock - column-shift transmission

This vehicle is equipped with a park/brake-shift interlock feature that prevents the gearshift lever from being moved from P (Park) when the ignition is in the ON position unless the brake pedal is depressed.

If you cannot move the gearshift lever out of P (Park) with ignition in the ON position and the brake pedal depressed, it is possible that a fuse has blown or the vehicle's brakelamps are not operating properly. Refer to *Fuses and relays* in the *Roadside Emergencies* chapter.

If the fuse is not blown, perform the following procedure:

1. Apply the parking brake, turn the ignition to OFF/LOCK, then remove the key.

Driving

2. Locate the round access plug on the underside of the steering column cover.

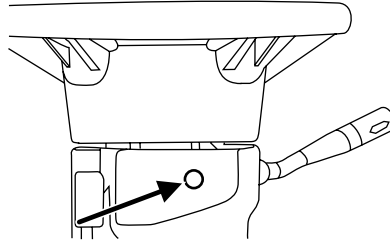

3. Remove the access plug using a flat head screwdriver, then push the override button using a flat head screwdriver, apply the brake pedal and shift the transmission into N (Neutral).

4. Reinstall the access plug cover, start the vehicle and release the parking brake.



Do not drive your vehicle until you verify that the brakelamps are working.



Always set the parking brake fully and make sure the gearshift is latched in P (Park). Turn the ignition to the OFF/LOCK position and remove the key whenever you leave your vehicle.



If the parking brake is fully released, but the brake warning lamp remains illuminated, the brakes may not be working properly. See your authorized dealer.

Brake-shift interlock - floor-shift transmission

This vehicle is equipped with a brake-shift interlock feature that prevents the gearshift lever from being moved from P (Park) when the ignition is in the ON position unless the brake pedal is depressed.

If you cannot move the gearshift lever out of P (Park) with ignition in the ON position and the brake pedal depressed, it is possible that a fuse has blown or the vehicle's brakelamps are not operating properly. Refer to *Fuses and relays* in the *Roadside Emergencies* chapter.

If the fuse is not blown, perform the following procedure:

1. Apply the parking brake, turn the ignition to LOCK, then remove the key.

Driving

2. Open the center console bin.
Using a screwdriver, carefully pry off the console finish panel surrounding the shifter mechanism by inserting a screwdriver into the latch slot as shown.

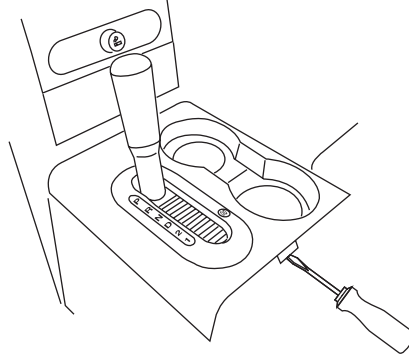

3. Remove console finish panel assembly to expose the inside of the gearshift.

4. Press and hold the white button located along side the shifter housing assembly (as shown in the illustration). Press the gearshift lever release on the shifter knob and move the gearshift lever back to N (Neutral) (two places rearward from P [Park]).

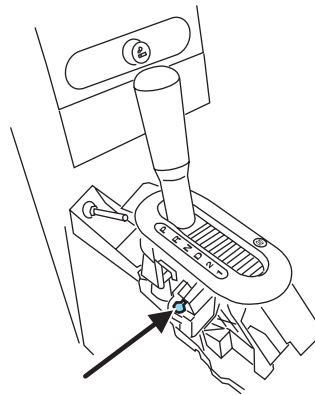

5. Start the vehicle and release the parking brake.



Do not drive your vehicle until you verify that the brakelamps are working.



Always set the parking brake fully and make sure the gearshift is latched in P (Park). Turn the ignition to the LOCK position and remove the key whenever you leave your vehicle.



If the parking brake is fully released, but the brake warning lamp remains illuminated, the brakes may not be working properly. See your authorized dealer.

Driving

Understanding the gearshift positions of the 4-speed automatic transmission

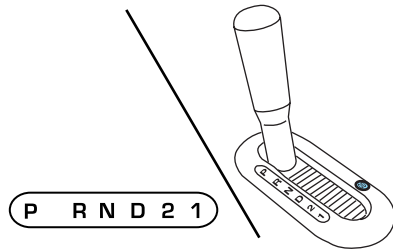

Your vehicle's automatic transmission is equipped with a special shift strategy that insures maximum heater performance during cold weather operation.

When ambient temperature is 23°F (-5°C) or below and the engine coolant temperature is below 100°F (38°C), light throttle upshifts may be slightly delayed. Once the engine coolant temperature reaches 160°F (71°C) the normal shift strategy will resume. This is normal operation and will not affect the function or the durability of the transmission.

If the normal shift strategy does not resume once the engine coolant temperature reaches the normal operating temperature, or if the downshifts and other throttle conditions do not function normally, see your authorized dealer as soon as possible.

P (Park)

This position locks the transmission and prevents the rear wheels from turning.

To put your vehicle in gear:

- Start the engine
- Depress the brake pedal
- Move the gearshift lever into the desired gear
- Release the parking brake.

Driving

To put your vehicle in P (Park):

- Come to a complete stop
- Move the gearshift lever and securely latch it in P (Park)

 Always set the parking brake fully and make sure the gearshift is latched in P (Park). Turn the ignition to the LOCK position and remove the key whenever you leave your vehicle.

R (Reverse)

With the gearshift lever in R (Reverse), the vehicle will move backward. Always come to a complete stop before shifting into and out of R (Reverse).

N (Neutral)

With the gearshift lever in N (Neutral), the vehicle can be started and is free to roll. Hold the brake pedal down while in this position.

D (Overdrive)

The normal driving position for the best fuel economy. Transmission operates in gears one through four.

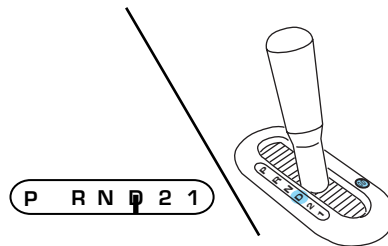

Overdrive can be deactivated by pressing the transmission control switch on the end of the gearshift lever (column-shift transmission) or on the gearshift bezel (floor-shift transmission).

- Column-shift transmission



Driving

- Floor-shift transmission

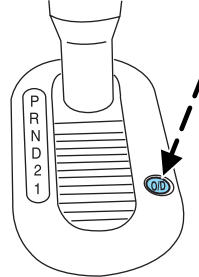

The transmission control indicator (TCIL) will illuminate on the instrument cluster.

**O/D
OFF**

Drive (not shown)

Drive is activated when the transmission control switch is pressed.

- This position allows for all forward gears except overdrive.
- O/D OFF lamp is illuminated.
- Provides engine braking.
- Use when driving conditions cause excessive shifting from O/D to other gears. Examples: city traffic, hilly terrain, heavy loads, trailer towing and when engine braking is required.
- To return to O/D (Overdrive), press the transmission control switch. The O/D OFF lamp will not be illuminated.
- O/D (Overdrive) is automatically returned each time the key is turned off.

2 (Second)

This position allows for second gear only.

- Provides engine braking.
- Use to start-up on slippery roads.
- To return to D (Overdrive), move the gearshift lever into the D (Overdrive) position.
- Selecting 2 (Second) at higher speeds will cause the transmission to downshift to second gear at the appropriate vehicle speed.

1 (First)

- Provides maximum engine braking.

222

Driving

- Allows upshifts by moving gearshift lever.
- Will not downshift into 1 (First) at high speeds; allows for 1 (First) when vehicle reaches slower speeds.

Forced downshifts

- Allowed in D (Overdrive) or Drive.
- Depress the accelerator to the floor.
- Allows transmission to select an appropriate gear.

If your vehicle gets stuck in mud or snow

If your vehicle gets stuck in mud or snow, it may be rocked out by shifting between forward and reverse gears, stopping between shifts in a steady pattern. Press lightly on the accelerator in each gear.

Do not rock the vehicle if the engine is not at normal operating temperature or damage to the transmission may occur.

Do not rock the vehicle for more than a minute or damage to the transmission and tires may occur, or the engine may overheat.

MANUAL TRANSMISSION OPERATION (IF EQUIPPED)

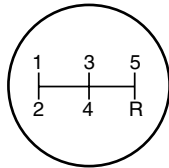

Using the clutch

The manual transmission has a starter interlock that prevents cranking the engine unless the clutch pedal is fully depressed.

To start the vehicle:

1. Make sure the parking brake is fully set.
2. Press the clutch pedal to the floor, then put the gearshift lever in the neutral position.
3. Start the engine, then press the brake pedal and release the parking brake.
4. Move the gearshift lever to the desired gear, 1 (First) or R (Reverse), then slowly release the clutch pedal while slowly pressing on the accelerator.

Driving

During each shift, the clutch pedal must be fully depressed to the floor. Make sure the floor mat is properly positioned so it doesn't interfere with the full extension of the clutch pedal.

Failure to fully depress the clutch pedal to the floor may cause increased shift efforts, prematurely wear transmission components or damage the transmission.

Do not drive with your foot resting on the clutch pedal or use the clutch pedal to hold your vehicle at a standstill while waiting on a hill. These actions will reduce the life of the clutch.

Recommended shift speeds

Upshift and downshift according to the following charts for your specific engine/drivetrain combination:

Upshifts when accelerating (recommended for best fuel economy)		
Shift from:	Transfer case position (if equipped)	
	2H or 4H	4L
1 - 2	15 mph (24 km/h)	9 mph (14 km/h)
2 - 3	25 mph (40 km/h)	12 mph (19 km/h)
3 - 4	37 mph (60 km/h)	15 mph (24 km/h)
4	45 mph (72 km/h)	18 mph (29 km/h)
- D (Overdrive)		

Upshifts when cruising (recommended for best fuel economy)		
Shift from:	Transfer case position (if equipped)	
	2H or 4H	4L
1 - 2	11 mph (18 km/h)	5 mph (8 km/h)
2 - 3	21 mph (34 km/h)	11 mph (18 km/h)
3 - 4	31 mph (50 km/h)	14 mph (23 km/h)
4	43 mph (69 km/h)	17 mph (27 km/h)
- D (Overdrive)		

Driving

Maximum downshift speeds ¹		
Shift from:	Transfer case position (if equipped)	
	2H or 4H	4L
ⓓ (Overdrive) - 4	55 mph (89 km/h)	21 mph (34 km/h)
4 - 3	45 mph (72 km/h)	17 mph (27 km/h)
3 - 2	35 mph (56 km/h)	13 mph (21 km/h)
2 - 1	20 mph (32 km/h)	7 mph (11 km/h)

¹Downshift at lower speeds when driving on slippery surfaces.

Reverse

1. Make sure that your vehicle is at a complete stop before you shift into R (Reverse). Failure to do so may damage the transmission.
2. Move the gearshift lever into the neutral position and wait at least three seconds before shifting into R (Reverse).
 - The gearshift lever can only be moved into R (Reverse) by moving it from left of 3 (Third) and 4 (Fourth) before shifting into R (Reverse). This is a lockout feature that protects the transmission from accidentally being shifted into R (Reverse) from 5 (Overdrive).

Parking your vehicle

1. Apply the brake and shift into the neutral position.
2. Fully apply the parking brake, then shift into 1 (First).
3. Turn the ignition off.



Do not park your vehicle in Neutral, it may move unexpectedly and injure someone. Use 1 (First) gear and set the parking brake fully.

REVERSE SENSING SYSTEM (IF EQUIPPED)

The Reverse Sensing System (RSS) sounds a tone to warn the driver of obstacles near the rear bumper when the R (Reverse) is selected and the vehicle is moving at speeds less than 3 mph (5 km/h). The system is not effective at speeds above 3 mph (5 km/h) and may not detect certain angular or moving objects.



To help avoid personal injury, please read and understand the limitations of the reverse sensing system as contained in this section. Reverse sensing is only an aid for some (generally large and fixed) objects when moving in reverse on a flat surface at “parking speeds”. Inclement weather may also affect the function of the RSS; this may include reduced performance or a false activation.

Driving



To help avoid personal injury, always use caution when in reverse and when using the RSS.



This system is not designed to prevent contact with small or moving objects. The system is designed to provide a warning to assist the driver in detecting large stationary objects to avoid damaging the vehicle. The system may not detect smaller objects, particularly those close to the ground.



Certain add-on devices such as large trailer hitches, bike or surfboard racks and any device that may block the normal detection zone of the RSS system may create false beeps.

The RSS detects obstacles up to 6 feet (2 meters) from the rear bumper with a decreased coverage area at the outer corners of the bumper, (refer to the figures for approximate zone coverage areas). As you move closer to the obstacle, the rate of the tone increases. When the obstacle is less than 10 inches (25.0 cm) away, the tone will sound continuously. If the RSS detects a stationary or receding object further than 10 inches (25.0 cm) from the side of the vehicle, the tone will sound for only three seconds. Once the system detects an object approaching, the tone will sound again.

The RSS may have reduced performance or an increased chance of false detection if the tailgate is not locked and in the upright position. If the tailgate is down, the RSS tone may be heard intermittently or continuously. The tone may also be heard if items in the truck bed protrude rearward outside the bed.

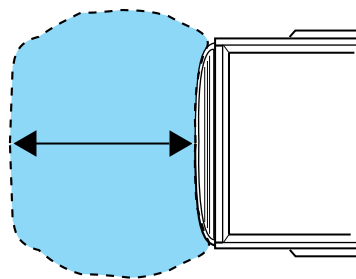
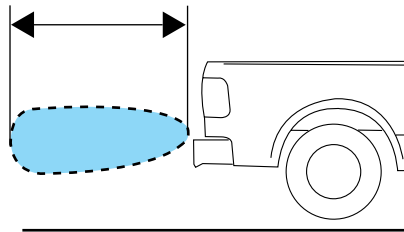

The RSS automatically turns on when the gearshift lever is placed in R (Reverse) and the ignition is ON. An RSS control allows the driver to turn the RSS on and off. To turn the RSS off, the ignition must be ON, and the gear selector in R (Reverse). An indicator light on the control will illuminate when the system is turned off. If the indicator light illuminates when the RSS is not turned off, it may indicate a failure in the RSS. The RSS will remain off until either the RSS control is pushed again or the ignition switch is recycled.

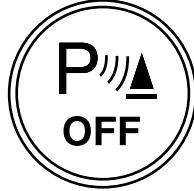

Keep the RSS sensors (located on the rear bumper/fascia) free from snow, ice and large accumulations of dirt (do not clean the sensors with sharp objects). If the sensors are covered, it will affect the accuracy of the RSS.

If your vehicle sustains damage to the rear bumper/fascia, leaving it misaligned or bent, the sensing zone may be altered causing inaccurate measurement of obstacles or false alarms.

FOUR-WHEEL DRIVE (4WD) OPERATION (IF EQUIPPED)



For important information regarding safe operation of this type of vehicle, see **Preparing to drive your vehicle** in this chapter.

Four-wheel drive (4WD) supplies power to all four wheels. 4WD should not be operated on dry pavement; driveline damage may occur.

If equipped with the Electronic Shift 4WD System, and 4WD Low is selected while the vehicle is moving above 3 mph (5 km/h), the 4WD system will not engage past 4WD High. This is normal and should be no reason for concern. Refer to *Shifting to/from 4L (4WD Low)* for proper operation.

System indicator lights

- **4X4 HI** - Momentarily illuminates when the engine is started. Illuminates when 4H is selected.

4x4 HI

Driving

- **4X4 LOW** – Momentarily illuminates when the engine is started. Illuminates when 4L is selected.

**4x4
LOW**

Using a manual 4WD system (if equipped)

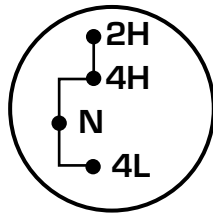

2H (2WD High) – Power to the rear wheels only; used for street and highway driving. Provides optimal smoothness and fuel economy at high speeds.

4H (4WD High) – Used for extra traction such as in snow or icy roads or in off-road situations. Not intended for use on dry pavement.

N (Neutral) – No power to either front or rear wheels.

4L (4WD Low)– Uses extra gearing to provide maximum power to all four wheels at reduced speeds. Intended only for off-road applications such as deep sand, steep grades or pulling heavy objects. 4L (4WD Low) will not engage while the vehicle is moving above 3 mph (5 km/h); this is normal and should be no reason for concern. Refer to *Shifting to/from 4L (4WD Low)* for proper operation.

Shifting between 2H (2WD high) and 4H (4WD high)

- Move the transfer case lever between 2H (2WD High) and 4H (4WD High) at a stop or any forward speed up to 55 mph (88 km/h).

Note: Do not perform this operation if the rear wheels are slipping.

Note: Some noise may be heard as the system shifts or engages; this is normal.

Shifting to/from 4L (4WD Low)

1. Bring the vehicle to a complete stop.
2. Place the transmission in N (Neutral).
3. Move the transfer case lever through N (Neutral) directly to the desired position.

228

Driving

- If the transfer case **will not** engage into 4L (4WD Low), allow the vehicle to coast at a speed below 3 mph (5 km/h), then repeat Steps 2 and 3.

Note: Some noise may be heard as the system shifts or engages; this is normal.

Note: For proper operation in 4WD Low, ensure the transfer case shift lever is moved entirely rearward in to the 4L (4WD Low) position and that the 4x4 Low light is illuminated.

Note: Ideal 4L (4WD Low) shift conditions occur when the vehicle is rolling at a speed below 3 mph (5 km/h) and the transmission is in N (Neutral).

Using the N (Neutral) position

The transfer case N (Neutral) position overrides the transmission and puts the vehicle in neutral regardless of transmission gearshift lever position. The vehicle can move forward or backward.

This position should only be used when towing the vehicle.



Do not leave the vehicle unattended with the transfer case in the N (Neutral) position. Always set the parking brake fully and turn off the ignition when leaving the vehicle.

Using the electronic shift 4WD system (if equipped)

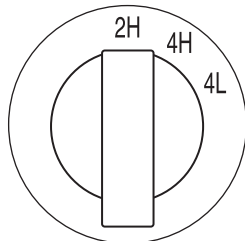

2H (2WD High) - Power to the rear wheels only; used for street and highway driving. Provides optimal smoothness and fuel economy at high speeds.

4H (4WD High) - Used for extra traction such as in snow or icy roads or in off-road situations. Not intended for use on dry pavement.

Driving

4L (4WD Low) - Uses extra gearing to provide maximum power to all four wheels at reduced speeds. Intended only for off-road applications such as deep sand, steep grades or pulling heavy objects. 4L (4WD Low) will not engage while the vehicle is moving above 3 mph (5 km/h); this is normal and should be no reason for concern. Refer to *Shifting to/from 4L (4WD Low)* for proper operation.

Shifting between 2H (2WD High) and 4H (4WD High)

- Move the 4WD control between 2H and 4H at any forward speed up to 55 mph (88 km/h).

Note: Do not perform this operation if the rear wheels are slipping.

Note: Some noise may be heard as the system shifts or engages; this is normal.

Shifting to/from 4L (4WD Low)

1. Bring the vehicle to a complete stop
2. Place the transmission in N (Neutral).
3. Move the 4WD control to the desired position.
 - If shifting into 4L (4WD Low), wait for the 4X4 LOW light in the instrument cluster to turn **on** indicating the shift is complete.
 - If shifting out of 4L (4WD Low), wait for the 4X4 LOW light in the instrument cluster to turn **off** indicating the shift is complete.

Note: Some noise may be heard as the system shifts or engages; this is normal.

Using the all-wheel drive (AWD) system (if equipped, Harley-Davidson only)

This system includes an electronically controlled transfer case. The system is interactive with the road, continually monitoring and adjusting torque delivery to the front and rear wheels to optimize traction.

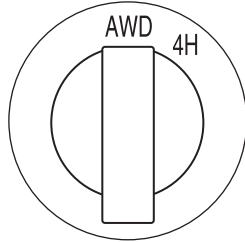

AWD (Auto) - Power delivered to all four wheels, as required, for increased traction. This is appropriate for all on-road driving conditions, such as dry road surfaces, wet pavement, snow, gravel and shallow sand.

4H (Lock) - The “4X4 HI” light will illuminate in the instrument cluster when this position is selected. This position is not recommended for use on dry pavement. This position is only intended for severe winter or off-road conditions, such as deep snow, ice or deep sand.

Shifting between AWD (Auto) and 4H (Lock)

Move the control from AWD to 4H at a stop or while driving at any speed.

Driving off-road with truck and utility vehicles

4WD vehicles are specially equipped for driving on sand, snow, mud and rough terrain and have operating characteristics that are somewhat different from conventional vehicles, both on and off the road.

How your vehicle differs from other vehicles

Truck and utility vehicles can differ from some other vehicles. Your vehicle may be higher to allow it to travel over rough terrain without getting hung up or damaging underbody components.

The differences that make your vehicle so versatile also make it handle differently than an ordinary passenger car.

Maintain steering wheel control at all times, especially in rough terrain. Since sudden changes in terrain can result in abrupt steering wheel motion, make sure you grip the steering wheel from the outside. Do not grip the spokes.

Drive cautiously to avoid vehicle damage from concealed objects such as rocks and stumps.

You should either know the terrain or examine maps of the area before driving. Map out your route before driving in the area. To maintain steering and braking control of your vehicle, you must have all four wheels on the ground and they must be rolling, not sliding or spinning.

Driving

Basic operating principles

- Do not use 4WD on dry, hard surfaced roads. Doing so will produce excessive noise, increase tire wear and may damage drive components. 4WD modes are only intended for consistently slippery or loose surfaces.
- Drive slower in strong crosswinds which can affect the normal steering characteristics of your vehicle.
- Be extremely careful when driving on pavement made slippery by loose sand, water, gravel, snow or ice.

If your vehicle goes off the edge of the pavement

- If your vehicle goes off the edge of the pavement, slow down, but avoid severe brake application, ease the vehicle back onto the pavement only after reducing your speed. Do not turn the steering wheel too sharply while returning to the road surface.
- It may be safer to stay on the apron or shoulder of the road and slow down gradually before returning to the pavement. You may lose control if you do not slow down or if you turn the steering wheel too sharply or abruptly.
- It often may be less risky to strike small objects, such as highway reflectors, with minor damage to your vehicle rather than attempt a sudden return to the pavement which could cause the vehicle to slide sideways out of control or roll over. Remember, your safety and the safety of others should be your primary concern.



Vehicles with a higher center of gravity such as utility and four-wheel drive vehicles handle differently than vehicles with a lower center of gravity. Utility and four-wheel drive vehicles are **not** designed for cornering at speeds as high as passenger cars any more than low-slung sports cars are designed to perform satisfactorily under off-road conditions. Avoid sharp turns, excessive speed and abrupt maneuvers in these vehicles. Failure to drive cautiously could result in an increased risk of loss of vehicle control, vehicle rollover, personal injury and death.

If your vehicle gets stuck

If your vehicle gets stuck in mud or snow it may be rocked out by shifting between forward and reverse gears, stopping between shifts, in a steady pattern. Press lightly on the accelerator in each gear.

Do not rock the vehicle if the engine is not at normal operating temperature or damage to the transmission may occur.

Driving

Do not rock the vehicle for more than a few minutes or damage to the transmission and tires may occur or the engine may overheat.



Do not spin the wheels at over 35 mph (56 km/h). The tires may fail and injure a passenger or bystander.

Emergency maneuvers

- In an unavoidable emergency situation where a sudden sharp turn must be made, remember to avoid “over-driving” your vehicle, i.e., turn the steering wheel only as rapidly and as far as required to avoid the emergency. Excessive steering will result in less vehicle control, not more. Additionally, smooth variations of the accelerator and/or brake pedal pressure should be utilized if changes in vehicle speed are called for. Avoid abrupt steering, acceleration or braking which could result in an increased risk of loss of vehicle control, vehicle rollover and/or personal injury. Use all available road surface to return the vehicle to a safe direction of travel.
- In the event of an emergency stop, avoid skidding the tires and do not attempt any sharp steering wheel movements.



Vehicles with a higher center of gravity such as utility and four-wheel drive vehicles handle differently than vehicles with a lower center of gravity. Utility and four-wheel drive vehicles are **not** designed for cornering at speeds as high as passenger cars any more than low-slung sports cars are designed to perform satisfactorily under off-road conditions. Avoid sharp turns, excessive speed and abrupt maneuvers in these vehicles. Failure to drive cautiously could result in an increased risk of loss of vehicle control, vehicle rollover, personal injury and death.

- If the vehicle goes from one type of surface to another (i.e., from concrete to gravel) there will be a change in the way the vehicle responds to a maneuver (steering, acceleration or braking). Again, avoid these abrupt inputs.

Parking

On some 4WD vehicles, when the transfer case is in the N (Neutral) position, the engine and transmission are disconnected from the rest of the driveline. Therefore, the vehicle is free to roll even if the automatic transmission is in P (Park) or the manual transmission is in gear. Do not

Driving

leave the vehicle unattended with the transfer case in the N (Neutral) position. Always set the parking brake fully and turn off the ignition when leaving the vehicle.



Always set the parking brake fully and make sure the gearshift is latched in P (Park). Turn the ignition to the LOCK position and remove the key whenever you leave your vehicle.



If the parking brake is fully released, but the brake warning lamp remains illuminated, the brakes may not be working properly. See your authorized dealer.

4WD Systems

4WD (when you select a 4WD mode) uses all four wheels to power the vehicle. This increases traction, enabling you to drive over terrain and road conditions that a conventional two-wheel drive vehicle cannot.

Power is supplied to all four wheels through a transfer case. On 4WD vehicles, the transfer case allows you to select 4WD when necessary. Information on transfer case operation and shifting procedures can be found in the *Driving* chapter. Information on transfer case maintenance can be found in the *Maintenance and Specifications* chapter. You should become thoroughly familiar with this information before you operate your vehicle.

Normal characteristics

On some 4WD models, the initial shift from two-wheel drive to 4x4 while the vehicle is moving can cause some momentary clunk and ratcheting sounds. This is the front drivetrain coming up to speed and the automatic locking hubs engaging and is not cause for concern.

Sand

When driving over sand, try to keep all four wheels on the most solid area of the trail. Avoid reducing the tire pressures but shift to a lower gear and drive steadily through the terrain. Apply the accelerator slowly and avoid spinning the wheels.

Avoid excessive speed because vehicle momentum can work against you and cause the vehicle to become stuck to the point that assistance may be required from another vehicle. Remember, you may be able to back out the way you came if you proceed with caution.

Mud and water

If you must drive through high water, drive slowly. Traction or brake capability may be limited.

When driving through water, determine the depth; avoid water higher than the bottom of the hubs (if possible) and proceed slowly. If the ignition system gets wet, the vehicle may stall.



Once through water, always try the brakes. Wet brakes do not stop the vehicle as effectively as dry brakes. Drying can be improved by moving your vehicle slowly while applying light pressure on the brake pedal.

Be cautious of sudden changes in vehicle speed or direction when you are driving in mud. Even 4WD vehicles can lose traction in slick mud. As when you are driving over sand, apply the accelerator slowly and avoid spinning your wheels. If the vehicle does slide, steer in the direction of the slide until you regain control of the vehicle.

If the transmission, transfer case or front axle are submerged in water, their fluids should be checked and changed, if necessary.

Driving through deep water may damage the transmission.

If the front or rear axle is submerged in water, the axle lubricant should be replaced.

After driving through mud, clean off residue stuck to rotating driveshafts and tires. Excess mud stuck on tires and rotating driveshafts causes an imbalance that could damage drive components.

“Tread Lightly” is an educational program designed to increase public awareness of land-use regulations and responsibilities in our nation's wilderness areas. Ford Motor

Company joins the U.S. Forest Service and the Bureau of Land Management in encouraging you to help preserve our national forest and other public and private lands by “treading lightly.”



Driving

Driving on hilly or sloping terrain

Although natural obstacles may make it necessary to travel diagonally up or down a hill or steep incline, you should always try to drive straight up or straight down. **Avoid driving crosswise or turning on steep slopes or hills.** A danger lies in losing traction, slipping sideways and possibly rolling over. Whenever driving on a hill, determine beforehand the route you will use. Do not drive over the crest of a hill without seeing what conditions are on the other side. Do not drive in reverse over a hill without the aid of an observer.

When climbing a steep slope or hill, start in a lower gear rather than downshifting to a lower gear from a higher gear once the ascent has started. This reduces strain on the engine and the possibility of stalling.

If you do stall out, do not try to turn around because you might roll over. It is better to back down to a safe location.

Apply just enough power to the wheels to climb the hill. Too much power will cause the tires to slip, spin or lose traction, resulting in loss of vehicle control.

Descend a hill in the same gear you would use to climb up the hill to avoid excessive brake application and brake overheating. Do not descend in neutral; instead, disengage overdrive or manually shift to a lower gear. When descending a steep hill, avoid sudden hard braking as you could lose control. When you brake hard, the front wheels can't turn and if they aren't turning, you won't be able to steer. The front wheels have to be turning in order to steer the vehicle. Rapid pumping of the brake pedal will help you slow the vehicle and still maintain steering control.

If your vehicle has anti-lock brakes, apply the brakes steadily. Do not "pump" the brakes.

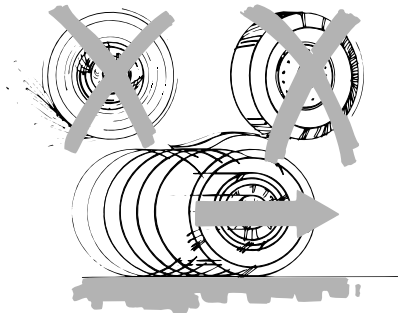
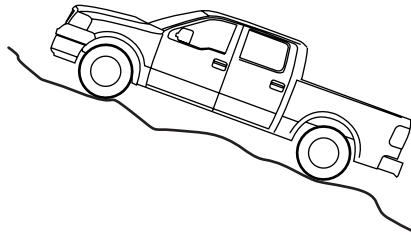

Driving on snow and ice

4WD vehicles have advantages over 2WD vehicles in snow and ice but can skid like any other vehicle.

Should you start to slide while driving on snowy or icy roads, turn the steering wheel in the direction of the slide until you regain control.

Avoid sudden applications of power and quick changes of direction on snow and ice. Apply the accelerator slowly and steadily when starting from a full stop.

Avoid sudden braking as well. Although a 4WD vehicle may accelerate better than a two-wheel drive vehicle in snow and ice, it won't stop any faster, because as in other vehicles, braking occurs at all four wheels. Do not become overconfident as to road conditions.

Make sure you allow sufficient distance between you and other vehicles for stopping. Drive slower than usual and consider using one of the lower gears. In emergency stopping situations, apply the brake steadily. Do not "pump" the brakes. Refer to the *Brakes* section of this chapter for additional information on the operation of the Anti-lock Brake System (ABS).

Never drive with chains on the front tires of 4WD vehicles without also putting them on the rear tires. This could cause the rear to slide and swing around during braking.

Maintenance and Modifications

The suspension and steering systems on your vehicle have been designed and tested to provide predictable performance whether loaded or empty and durable load carrying capability. For this reason, Ford Motor Company strongly recommends that you do not make modifications such as adding or removing parts (such as lift kits or stabilizer bars) or by using replacement parts not equivalent to the original factory equipment.

Any modifications to a vehicle that raise the center of gravity can make it more likely the vehicle will roll over as a result of a loss of control. Ford Motor Company recommends that caution be used with any vehicle equipped with a high load or device (such as ladder racks or pickup box cover).

Failure to maintain your vehicle properly may void the warranty, increase your repair cost, reduce vehicle performance and operational capabilities and adversely affect driver and passenger safety. Frequent inspection of vehicle chassis components is recommended if the vehicle is subjected to heavy off-road usage.

Driving

DRIVING THROUGH WATER

If driving through deep or standing water is unavoidable, proceed very slowly especially when the depth is not known. Never drive through water that is higher than the bottom of the wheel rims (for cars) or the bottom of the hubs (for trucks).

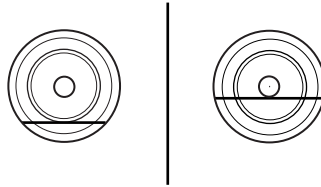

When driving through water, traction or brake capability may be limited. Also, water may enter your engine's air intake and severely damage your engine or your vehicle may stall. **Driving through deep water where the transmission vent tube is submerged may allow water into the transmission and cause internal transmission damage.**

Once through the water, always dry the brakes by moving your vehicle slowly while applying light pressure on the brake pedal. Wet brakes do not stop the vehicle as quickly as dry brakes.

SNOWPLOWING

For F-150 snowplow applications, Ford recommends the F-150 4x4 Regular Cab and SuperCab equipped with the 5.4L engine, Heavy Duty Payload Package and Snow Plow Prep Package. The Heavy Duty Payload Package for 4x4 includes unique powertrain control strategy, required for engine cooling when the raised snowplow blade blocks radiator airflow in highway driving. F-150 SuperCrew and Harley-Davidson F-150 are not recommended for snowplowing and the Snow Plow Prep Package is not available.

Installing the snowplow

Weight limits and guidelines for selecting and installing the snowplow can be found in the Ford Truck Body Builders Layout Book, Snowplow section, found at www.fleet.ford.com/truckbbas. A typical installation affects the following:

- Certification to government safety laws such as occupant protection and air bag deployment, braking, and lighting. Look for an "Alterer's Label" on the vehicle from the snowplow installer certifying that the installation meets all applicable Federal Motor Vehicle Safety Standards (FMVSS).
- The Total Accessory Reserve Capacity (TARC) is shown on the lower right side of the vehicle's Safety Certification Label. This is the weight of permanently-attached auxiliary equipment, such as snowplow frame-mounting hardware, that can be added to the vehicle and satisfy

Driving

Ford compliance certification to FMVSS. Exceeding this weight may require the auxiliary equipment installer additional safety certification responsibility. The Front Accessory Reserve Capacity (FARC) is added for customer convenience

- Rear ballast weight behind the rear axle may be required to prevent exceeding the FGAWR, and provide front-to-rear weight balance for proper braking and steering.
- Front wheel toe may require re-adjustment to prevent premature uneven tire wear. Specifications are found in the Ford Workshop Manual.
- Headlight aim may require re-adjustment.
- The tire air pressures recommended for general driving are found on the vehicle's Safety Certification Label. The maximum cold inflation pressure for the tire and associated load rating is imprinted on the tire sidewall. Tire air pressure may require re-adjustment within these pressure limits to accommodate the additional weight of the snowplow installation

Operating the vehicle with the snowplow attached

Ford recommends that the F-150 be limited to low speed, personal-use snow removal. Do not use your vehicle for snow removal until it has been driven at least 500 miles (800 km).

The attached snowplow blade restricts airflow to the radiator, and may cause the engine to run at a higher temperature. Attention to engine temperature is especially important when outside temperatures are above freezing. Angle the blade to maximize airflow to the radiator and monitor engine temperature to determine whether a left or right angle provides the best performance.

Snowplowing with your air bag equipped vehicle

Your vehicle is equipped with a driver and passenger air bag Supplemental Restraint System (SRS) The SRS is designed to activate in certain frontal and offset frontal collisions when the vehicle sustains sufficient longitudinal deceleration.

Careless or high speed driving while plowing snow which results in sufficient vehicle decelerations can deploy the air bag. Such driving also increases the risk of accidents.



All occupants of the vehicle, including the driver, should always properly wear their safety belts, even when an air bag supplemental restraint system (SRS) is provided.

Driving

Never remove or defeat the “tripping mechanisms” designed into the snow removal equipment by its manufacturer. Doing so may cause damage to the vehicle and the snow removal equipment as well as possible air bag deployment.



Do not attempt to service, repair, or modify the air bag supplemental restraint system (SRS) or its fuses. See your Ford or Lincoln Mercury dealer.

Transmission operation while plowing

- Shift transfer case to 4L (4WD Low) when plowing in small areas at speeds below 5 mph (8 km/h).
- Shift transfer case to 4H (4WD High) when plowing larger areas or light snow at higher speeds. Do not exceed 15 mph (24 km/h).
- Do not shift the transmission from a forward gear to R (Reverse) until the engine is at idle and the wheels are stopped.
- If the vehicle is stuck, shift the transmission in a steady motion between forward and reverse gears. Do not rock the vehicle for more than a few minutes. The transmission and tires may be damaged or the engine can overheat.

Do not rock the vehicle if the engine is not at operating temperature. Do not rock the vehicle for more than a minute. The transmission and tires may be damaged or the engine may overheat.



Do not spin the wheels at over 35 mph (55 km/h). The tires may fail and injure a passenger or bystander.

Engine temperature while plowing

When driving with a plow, your engine may run at a higher temperature than normal because the attached snowplow blade will restrict airflow to the radiator.

If you are driving more than 15 miles (24 km) at temperatures above freezing, angle the plow blade either full left or full right to provide maximum airflow to the radiator.

If you are driving less than 15 miles (24 km) at speeds up to 40 mph (64 km/h) in cold weather, you will not need to worry about blade position to provide maximum airflow.

Roadside Emergencies

ROADSIDE ASSISTANCE

Getting roadside assistance

To fully assist you should you have a vehicle concern, Ford Motor Company offers a complimentary roadside assistance program. This program is separate from the New Vehicle Limited Warranty. The service is available:

- 24-hours, seven days a week
- for the New Vehicle Limited Warranty period of three years or 36,000 miles (60,000 km), whichever occurs first on Ford and Mercury vehicles, and four years or 50,000 miles (80,000 km) on Lincoln vehicles.

Roadside assistance will cover:

- a flat tire change with a good spare (except Ford GT which has a tire inflation kit)
- battery jump start
- lock-out assistance (key replacement cost is the customer's responsibility)
- fuel delivery – Independent Service Contractors, if not prohibited by state, local or municipal law shall deliver up to 2.0 gallons (7.5L) of gasoline or 5 gallons (18.9L) of diesel fuel to a disabled vehicle. Fuel delivery service is limited to two no-charge occurrences within a 12-month period.
- winch out – available within 100 feet (30.5 meters) of a paved or county maintained road, no recoveries.
- towing – Ford/Mercury/Lincoln eligible vehicle towed to an authorized dealer within 35 miles (56.3 km) of the disablement location or to the nearest authorized dealer. If a member requests to be towed to an authorized dealer more than 35 miles (56.3 km) from the disablement location, the member shall be responsible for any mileage costs in excess of 35 miles (56.3 km).

Trailers shall be covered up to \$100 if the disabled eligible vehicle requires service at the nearest authorized dealer. If the trailer is disabled, but the towing vehicle is operational, the trailer does not qualify for any roadside services.

Roadside Emergencies

Canadian customers refer to your Owner Information Guide for information on:

- coverage period
- exact fuel amounts
- towing of your disabled vehicle
- emergency travel expense reimbursement
- travel planning benefits

Using roadside assistance

Complete the roadside assistance identification card and place it in your wallet for quick reference. In the United States, this card is found in the Owner Guide portfolio in the glove compartment. In Canada, the card is found in the *Owner Information Guide* in the glove compartment.

U.S. Ford or Mercury vehicle customers who require roadside assistance, call 1-800-241-3673; Lincoln vehicle customers call 1-800-521-4140.

Canadian customers who require roadside assistance, call 1-800-665-2006.

If you need to arrange roadside assistance for yourself, Ford Motor Company will reimburse a reasonable amount. To obtain reimbursement information, U.S. Ford or Mercury vehicles customers call 1-800-241-3673; Lincoln vehicle customers call 1-800-521-4140.

Canadian customers who need to obtain reimbursement information, call 1-800-665-2006.

Roadside coverage beyond basic warranty

In the United States, you may purchase additional roadside assistance coverage beyond this period through the Ford Auto Club by contacting your authorized dealer.

Similarly in Canada, for uninterrupted Roadside Assistance coverage, you may purchase extended coverage prior to your Basic Warranty's Roadside Assistance expiring. For more information and enrollment, contact 1-877-294-2582 or visit our website at www.ford.ca.

Roadside Emergencies

HAZARD FLASHER

The hazard flasher is located on the steering column, just behind the steering wheel. The hazard flashers will operate when the ignition is in any position or if the key is not in the ignition.

Push in the flasher control and all front and rear direction signals will flash. Press the flasher control again to turn them off. Use it when your vehicle is disabled and is creating a safety hazard for other motorists.

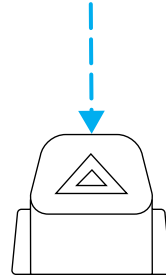

Note: With extended use, the flasher may run down your battery.

FUEL PUMP SHUT-OFF SWITCH

This device stops the electric fuel pump from sending fuel to the engine when your vehicle has had a substantial jolt.

After an accident, if the engine cranks but does not start, this switch may have been activated.

Roadside Emergencies

This switch is located in the front passenger's footwell, behind the kick panel access cover, to the left of the fuse box. The access cover needs to be removed to reset the fuel pump shut-off switch.

To reset the switch:

1. Turn the ignition OFF.
2. Check the fuel system for leaks.
3. If no leaks are apparent, reset the switch by pushing in on the reset button.
4. Turn the ignition ON.
5. Wait a few seconds and return the key to OFF.
6. Make another check for leaks.

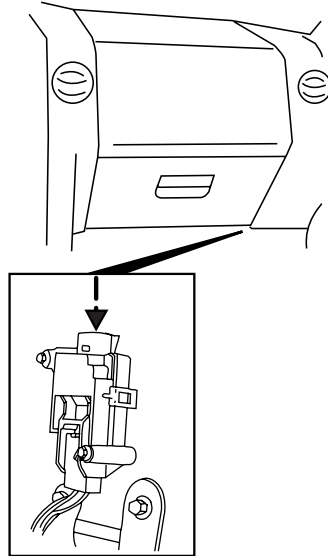

FUSES AND RELAYS

Fuses

If electrical components in the vehicle are not working, a fuse may have blown. Blown fuses are identified by a broken wire within the fuse. Check the appropriate fuses before replacing any electrical components.

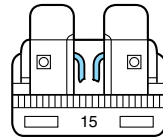

Note: Always replace a fuse with one that has the specified amperage rating. Using a fuse with a higher amperage rating can cause severe wire damage and could start a fire.

Roadside Emergencies

Standard fuse amperage rating and color

COLOR					
Fuse rating	Mini fuses	Standard fuses	Maxi fuses	Cartridge maxi fuses	Fuse link cartridge
2A	Grey	Grey	—	—	—
3A	Violet	Violet	—	—	—
4A	Pink	Pink	—	—	—
5A	Tan	Tan	—	—	—
7.5A	Brown	Brown	—	—	—
10A	Red	Red	—	—	—
15A	Blue	Blue	—	—	—
20A	Yellow	Yellow	Yellow	Blue	Blue
25A	Natural	Natural	—	—	—
30A	Green	Green	Green	Pink	Pink
40A	—	—	Orange	Green	Green
50A	—	—	Red	Red	Red
60A	—	—	Blue	—	Yellow
70A	—	—	Tan	—	Brown
80A	—	—	Natural	—	Black

Passenger compartment fuse panel / power distribution box

The fuse panel is located under the right-hand side of the instrument panel. Remove the trim panel and fuse box cover to access the fuses.

To remove the fuse box cover, place a finger behind the PULL tab and your thumb above the PULL tab as shown in the illustration, then pull the cover off.

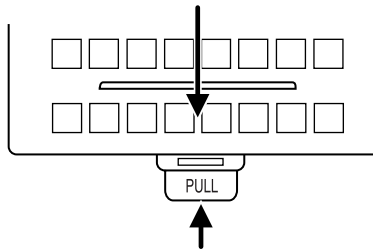

To reinstall the fuse box cover, place the top part of the cover on the fuse panel, then push the bottom part of the cover until you hear it click shut. Gently pull on the cover to make sure it is seated properly.

Roadside Emergencies



Always disconnect the battery before servicing high current fuses.



To reduce risk of electrical shock, always replace the cover to the Power Distribution Box and Auxiliary Relay Box before reconnecting the battery or refilling fluid reservoirs.

If the battery has been disconnected and reconnected, refer to the *Battery* section of the *Maintenance and Specifications* chapter.

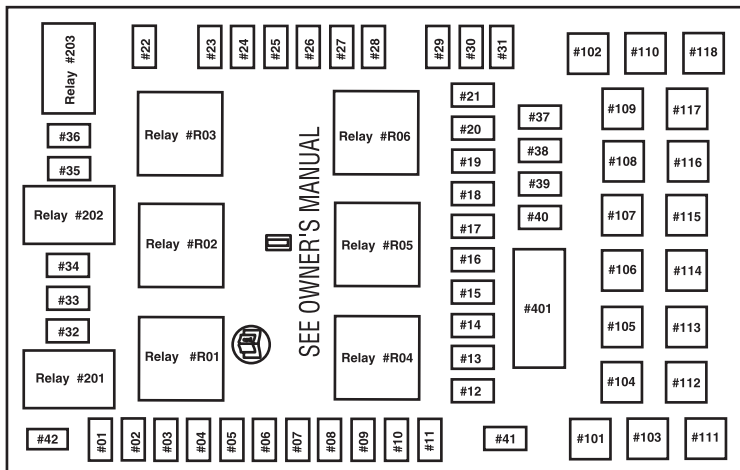

Roadside Emergencies

The fuses are coded as follows.

Fuse/Relay Location	Fuse Amp Rating	Passenger Compartment Fuse Panel Description
1	10A*	Run/Accessory - Wipers, Instrument cluster, Audio for XL/STX
2	20A*	Stop/Turn lamps, Brake on/off switch, Hazard flashers
3	7.5A*	Power mirrors, Memory seats and pedals, Driver power seat
4	10A*	DVD battery power, Power fold mirror
5	7.5A*	Keep alive memory for Powertrain Control Module (PCM) and climate control module
6	15A*	Parklamps, BSM, Instrument panel illumination
7	5A*	Radio (start signal)
8	10A*	Heated mirrors, Switch indicator
9	20A*	Fuel pump relay, Fuel injectors, Intake manifold runner control (4.2L)
10	20A*	Trailer tow back-up lamps relay (PCB1), Trailer tow parklamp relay (R201)
11	10A*	A/C clutch, 4x4 solenoid
12	5A*	PCM relay coil
13	10A*	Climate control module power, Flasher relay

Roadside Emergencies

Fuse/Relay Location	Fuse Amp Rating	Passenger Compartment Fuse Panel Description
14	10A*	Back-up lamp and Daytime Running Lamps (DRL) relay coil, A/C pressure switch, Redundant speed control switch, Heated PCV (5.4L), Trailer tow back-up lamps relay coil, ABS, Reverse park aid, EC mirror, Navigation radio (reverse input)
15	5A*	Overdrive cancel, Cluster, Traction control switch
16	10A*	Brake-shift interlock solenoid
17	15A*	Fog lamp relay (R202)
18	10A*	Run/Start feed - Overhead power point, Electrochromatic mirror, Heated seats, BSM, Compass, RSS (Reverse Sensing System)
19	10A*	Restraints (Air bag module), OCS
20	10A*	Battery feed for overhead power point
21	15A*	Cluster keep alive power
22	10A*	Delayed accessory power for audio, power door lock switch and moon roof switch illumination
23	10A*	RH low beam headlamp
24	15A*	Battery saver power for demand lamps
25	10A*	LH low beam headlamp
26	20A*	Horn relay (PCB3), Horn power
27	5A*	Passenger Air bag Deactivation (PAD) warning lamp, Cluster RUN /START power
28	5A*	SecuriLock transceiver (PATS), PCM IGN monitor

Roadside Emergencies

Fuse/Relay Location	Fuse Amp Rating	Passenger Compartment Fuse Panel Description
29	15A*	PCM 4x4 power
30	15A*	PCM 4x4 power
31	20A*	Radio power, Satellite radio module
32	15A*	Vapor Management Valve (VMV), A/C clutch relay, Canister vent, Heated Exhaust Gas Oxygen (HEGO) sensors #11 and #21, CMCV, Mass Air Flow (MAF) sensor, VCT, Heated Positive Crankcase Ventilation (PCV) valve (4.2L engine), CID sensor (4.2L engine), 4.6L/4.2L EGR , Electronic fan clutch (4.6L/5.4L engines)
33	15A*	Shift solenoid, CMS #12 and #22, Ignition coils
34	15A*	PCM power
35	20A*	Instrument cluster high beam indicator, High beam headlamps
36	10A*	Trailer tow right turn/stop lamps
37	20A*	Rear power point, Center console power point
38	25A*	Subwoofer power
39	20A*	Instrument panel power point
40	20A*	Low beam headlamps, DRL
41	20A*	Cigar lighter, Diagnostic connector power
42	10A*	Trailer tow left turn/stop lamps
101	30A**	Starter solenoid
102	20A**	Ignition switch feed
103	20A**	ABS valves

Roadside Emergencies

Fuse/Relay Location	Fuse Amp Rating	Passenger Compartment Fuse Panel Description
104	—	Not used
105	30A**	Electric trailer brakes
106	30A**	Trailer tow battery charge
107	30A**	Power door locks (BSM)
108	30A**	Passenger power seat
109	30A**	Driver power seat, Adjustable pedals, Memory module (pedals, seat, mirror)
110	—	Not used
111	30A**	4x4 relays
112	40A**	ABS pump power
113	30A**	Wipers and washer pump
114	40A**	Heated backlite, Heated mirror power
115	20A**	Not used (Spare)
116	30A**	Blower motor
117	—	Not used
118	30A**	Heated seats
401	30A Circuit breaker	Delayed accessory power: Power windows, Moon roof, Power sliding backlite
R01	Full ISO relay	Starter solenoid
R02	Full ISO relay	Accessory delay
R03	Full ISO relay	Hi-beam headlamps
R04	Full ISO relay	Heated backlite
R05	Full ISO relay	Trailer tow battery charge
R06	Full ISO relay	Blower motor
R201	Half ISO relay	Trailer tow park lamps
R202	Half ISO relay	Fog lamps
R203	Half ISO relay	PCM

* Mini fuses ** Cartridge fuses

Roadside Emergencies

Auxiliary relay box

The relay box is located in the engine compartment on the left fender.

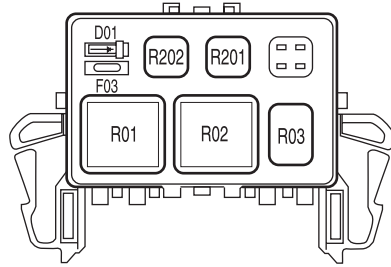

- With Daytime Running Lamp (DRL) and 4x4 options

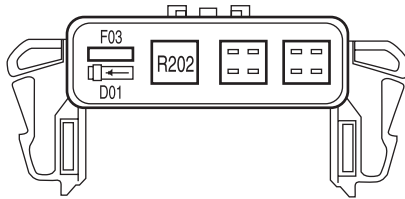

- Without Daytime Running Lamp (DRL) and 4x4 options

The relays are coded as follows:

Fuse/Relay Location	Fuse Amp Rating	Description
F03	5A	Clockspring illumination
R01	Full ISO Relay	4x4 CCW
R02	Full ISO Relay	4x4 CW
R03	½ ISO Relay	Daytime Running Lamps (DRL) high beam disable
R201	Relay	DRL
R202	Relay	A/C clutch
D01	Diode	A/C clutch

Roadside Emergencies

CHANGING THE TIRES

If you get a flat tire while driving, do not apply the brake heavily. Instead, gradually decrease your speed. Hold the steering wheel firmly and slowly move to a safe place on the side of the road.

Note: If your vehicle is equipped with the tire pressure monitoring system (TPMS), the indicator light will illuminate when the spare tire is in use. To restore the full functionality of the monitoring system, all road wheels equipped with tire pressure monitoring sensors must be mounted on the vehicle.

If your vehicle is equipped with TPMS, have a flat serviced by an authorized dealer in order to prevent damage to the TPMS sensors, refer to *Tire Pressure Monitoring System (TPMS)* in the *Tires, Wheels and Loading* chapter.



The use of tire sealants may damage your tires. The use of tire sealants may also damage your Tire Pressure Monitoring System and should not be used.



Refer to *Tire Pressure Monitoring System (TPMS)* in the *Tires, Wheels and Loading* chapter for important information. If the tire pressure monitor sensor becomes damaged, it will no longer function.

Dissimilar spare tire/wheel information



Failure to follow these guidelines could result in an increased risk of loss of vehicle control, injury or death.

If you have a dissimilar spare tire/wheel, then it is intended for temporary use only. This means that if you need to use it, you should replace it as soon as possible with a road tire/wheel that is the same size and type as the road tires and wheels that were originally provided by Ford. If the dissimilar spare tire or wheel is damaged, it should be replaced rather than repaired.

A dissimilar spare tire/wheel is defined as a spare tire and/or wheel that is different in brand, size or appearance from the road tires and wheels and can be one of three types:

1. **T-type mini-spare:** This spare tire begins with the letter “T” for tire size and may have “Temporary Use Only” molded in the sidewall

Roadside Emergencies

2. **Full-size dissimilar spare with label on wheel:** This spare tire has a label on the wheel that states: "THIS TIRE AND WHEEL FOR TEMPORARY USE ONLY"

When driving with one of the dissimilar spare tires listed above, **do not:**

- Exceed 50 mph (80 km/h)
- Load the vehicle beyond maximum vehicle load rating listed on the Safety Compliance Label
- Tow a trailer
- Use snow chains on the end of the vehicle with the dissimilar spare tire
- Use more than one dissimilar spare tire at a time
- Use commercial car washing equipment
- Try to repair the dissimilar spare tire

Use of one of the dissimilar spare tires listed above at any one wheel location can lead to impairment of the following:

- Handling, stability and braking performance
- Comfort and noise
- Ground clearance and parking at curbs
- Winter weather driving capability
- Wet weather driving capability

For vehicles equipped with 4WD, it is not recommended that the vehicle be operated in 4WD modes with a temporary emergency spare tire. If 4WD operation is necessary, do not operate above speeds of 10 mph (16 km/h) or for distances above 50 miles (80 km).

3. **Full-size dissimilar spare without label on wheel**

When driving with the full-size dissimilar spare tire/wheel, **do not:**

- Exceed 70 mph (113 km/h)
- Use more than one dissimilar spare tire/wheel at a time
- Use commercial car washing equipment
- Use snow chains on the end of the vehicle with the dissimilar spare tire/wheel

The usage of a full-size dissimilar spare tire/wheel can lead to impairment of the following:

- Handling, stability and braking performance

Roadside Emergencies

- Comfort and noise
- Ground clearance and parking at curbs
- Winter weather driving capability
- Wet weather driving capability
- All-Wheel driving capability (if applicable)
- Load leveling adjustment (if applicable)

When driving with the full-size dissimilar spare tire/wheel additional caution should be given to:

- Towing a trailer
- Driving vehicles equipped with a camper body
- Driving vehicles with a load on the cargo rack

Drive cautiously when using a full-size dissimilar spare tire/wheel and seek service as soon as possible.

Location of the spare tire and tools

The spare tire and tools for your vehicle are stowed in the following locations:

Tool	Location
Spare tire	Under the vehicle, just forward of the rear bumper
Jack, jack handle and lug nut wrench	Regular Cab: Behind the interior trim on the passenger side of the cab SuperCrew and SuperCab: Under the rear seat on the passenger side

The wing nut must be removed and the jack screw turned counterclockwise to release pressure before the jack can be removed from the holder.

Roadside Emergencies

Removing the spare tire

1. Use the ignition key to remove the lock cylinder from the access hole of the bumper to allow access to the guide tube. Assemble the jack handle as shown in the illustration.

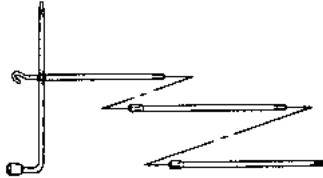

2. Fully insert the jack handle through the bumper hole and into the guide tube through the access hole in the rear bumper.

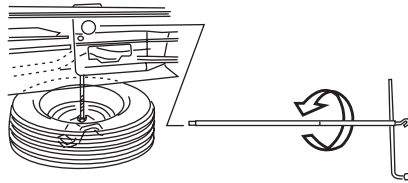

3. Turn the handle counterclockwise until tire is lowered to the ground, the tire can be slid rearward and the cable is slightly slack.

4. Slide the retainer through the center of the wheel.

Tire change procedure

 To help prevent the vehicle from moving when you change a tire, be sure the parking brake is set, then block (in both directions) the wheel that is diagonally opposite (other side and end of the vehicle) to the tire being changed.

 If the vehicle slips off the jack, you or someone else could be seriously injured.

Refer to the instruction sheet (located with the jack) for detailed tire change instructions.

Roadside Emergencies

1. Park on a level surface, activate hazard flashers and set the parking brake.
2. Place gearshift lever in P (Park) and turn engine OFF.

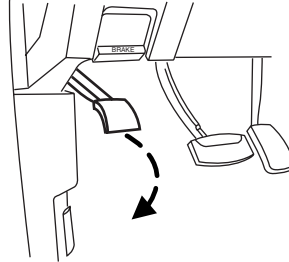

3. Block the diagonally opposite wheel.
4. Obtain the spare tire and jack from their storage locations.
5. Use the tip of the lug wrench to remove any wheel trim.
6. Loosen each wheel lug nut one-half turn counterclockwise but do not remove them until the wheel is raised off the ground.

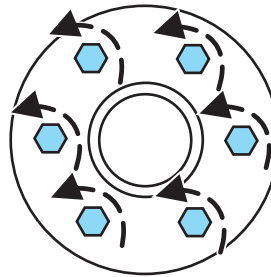
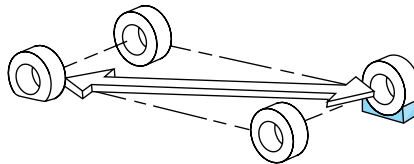

7. Position the jack according to the following guides and turn the jack handle clockwise until the wheel is completely off the ground.



When one of the rear wheels is off the ground, the transmission alone will not prevent the vehicle from moving or slipping off the jack, even if the transmission is in P (Park). To prevent the vehicle from moving when you change the tire, be sure that the parking brake is set and the diagonally opposite wheel is blocked. If the vehicle slips off the jack, someone could be seriously injured.

Roadside Emergencies

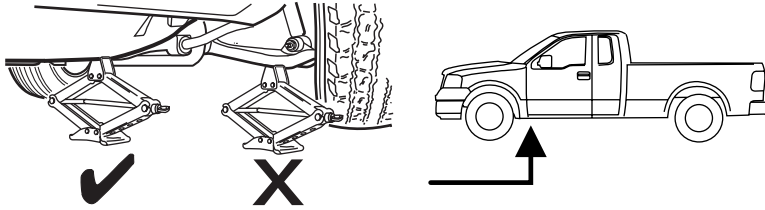

- Front

Note: Use the frame rail as the jacking location point, NOT the control arm.

- Rear

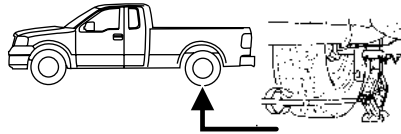

 To lessen the risk of personal injury, do not put any part of your body under the vehicle while changing a tire. Do not start the engine when your vehicle is on the jack. The jack is only meant for changing the tire.

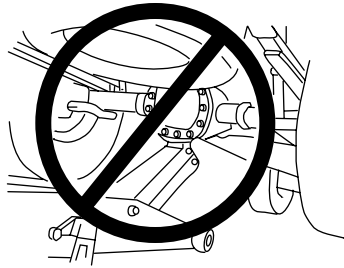

- **Never use the front or rear differential as a jacking point.**

8. Remove the lug nuts with the lug wrench.
9. Replace the flat tire with the spare tire, making sure the valve stem is facing outward. Reinstall the lug nuts until the wheel is snug against the hub. Do not fully tighten the lug nuts until the wheel has been lowered.
10. Lower the wheel by turning the jack handle counterclockwise.

Roadside Emergencies

11. Remove the jack and fully tighten the lug nuts in the order shown (Refer to *Wheel lug nut torque specifications* later in this chapter for the proper lug nut torque specification):

- Six lug nut wheel

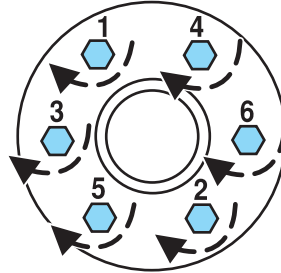

- Seven lug nut wheel

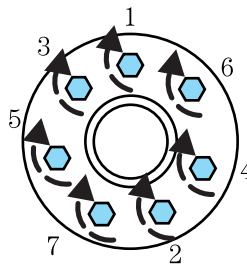

12. Stow the flat tire. Refer to *Stowing the flat/spare tire*.

13. Stow the jack and lug wrench. Make sure the jack is fastened so it does not rattle when you drive.

14. Unblock the wheels.

Stowing the flat/spare tire

Note: Failure to follow spare tire stowage instructions may result in failure of cable or loss of spare tire.

1. Lay the tire on the ground with the valve stem facing in the direction specified on the Tire Changing Instructions located with the jack hardware.

2. Slide the wheel partially under the vehicle and install the retainer through the wheel center. Pull on the cable to align the components at the end of the cable.

3. Turn the jack handle clockwise until the tire is raised to its stowed position underneath the vehicle. The effort to turn the jack handle increases significantly and the spare tire carrier ratchets or slips when the tire is raised to the maximum tightness. Tighten to the best of your ability, to the point where the ratchet/slip occurs, if possible. The spare tire carrier will not allow you to overtighten. If the spare tire carrier

Roadside Emergencies

ratchets or slips with little effort, take the vehicle to your authorized dealer for assistance at your earliest convenience.

4. Check that the tire lies flat against the frame and is properly tightened. Try to push or pull, then turn the tire to be sure it will not move. Loosen and retighten, if necessary. Failure to properly stow the spare tire may result in failure of the winch cable and loss of the tire.
5. Repeat this tightness check procedure when servicing the spare tire pressure (every six months, as per your *scheduled maintenance information*), or at any time that the spare tire is disturbed through service of other components.
6. If removed, install the spare tire lock (if equipped) into the bumper drive tube with the spare tire lock key (if equipped) and jack handle.

WHEEL LUG NUT TORQUE SPECIFICATIONS

Retighten the lug nuts to the specified torque within 100 miles (160 km) after any wheel disturbance (rotation, flat tire, wheel removal, etc.).

Bolt size	Wheel lug nut torque*	
	lb.ft.	N•m
M14 x 2.0	150	200

* Torque specifications are for nut and bolt threads free of dirt and rust. Use only Ford recommended replacement fasteners.



When a wheel is installed, always remove any corrosion, dirt or foreign materials present on the mounting surfaces of the wheel or the surface of the wheel hub, brake drum or brake disc that contacts the wheel. Ensure that any fasteners that attach the rotor to the hub are secured so they do not interfere with the mounting surfaces of the wheel. Installing wheels without correct metal-to-metal contact at the wheel mounting surfaces can cause the wheel nuts to loosen and the wheel to come off while the vehicle is in motion, resulting in loss of control.

JUMP STARTING



The gases around the battery can explode if exposed to flames, sparks, or lit cigarettes. An explosion could result in injury or vehicle damage.

Roadside Emergencies



Batteries contain sulfuric acid which can burn skin, eyes and clothing, if contacted.

Do not attempt to push-start your automatic transmission vehicle. Automatic transmissions do not have push-start capability. Attempting to push-start a vehicle with an automatic transmission may cause transmission damage.

Preparing your vehicle

When the battery is disconnected or a new battery is installed, the automatic transmission must relearn its shift strategy. As a result, the transmission may have firm and/or soft shifts. This operation is considered normal and will not affect function or durability of the transmission. Over time, the adaptive learning process will fully update transmission operation.

1. **Use only a 12-volt supply to start your vehicle.**
2. Do not disconnect the battery of the disabled vehicle as this could damage the vehicle's electrical system.
3. Park the booster vehicle close to the hood of the disabled vehicle making sure the two vehicles **do not** touch. Set the parking brake on both vehicles and stay clear of the engine cooling fan and other moving parts.
4. Check all battery terminals and remove any excessive corrosion before you attach the battery cables. Ensure that vent caps are tight and level.
5. Turn the heater fan on in both vehicles to protect from any electrical surges. Turn all other accessories off.

Connecting the jumper cables

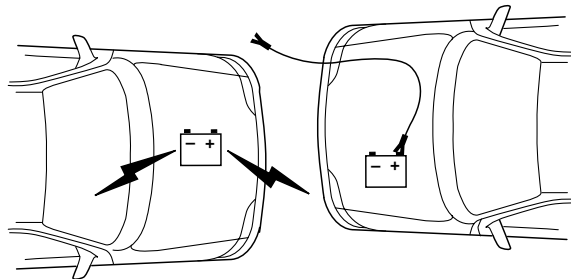

Roadside Emergencies

1. Connect the positive (+) jumper cable to the positive (+) terminal of the discharged battery.

Note: In the illustrations, *lightning bolts* are used to designate the assisting (boosting) battery.

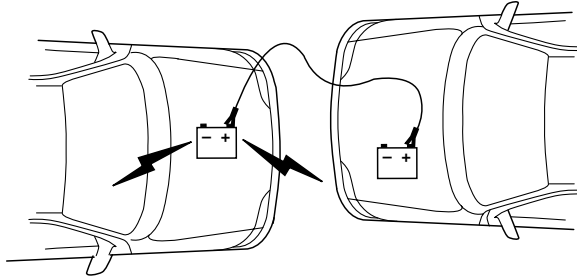

2. Connect the other end of the positive (+) cable to the positive (+) terminal of the assisting battery.

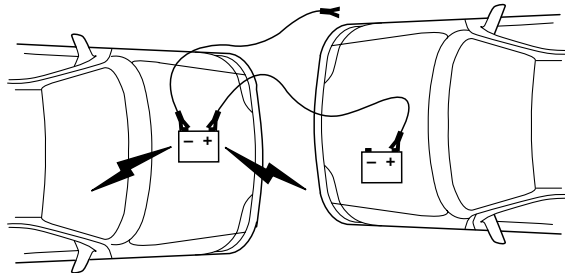

3. Connect the negative (-) cable to the negative (-) terminal of the assisting battery.

Roadside Emergencies

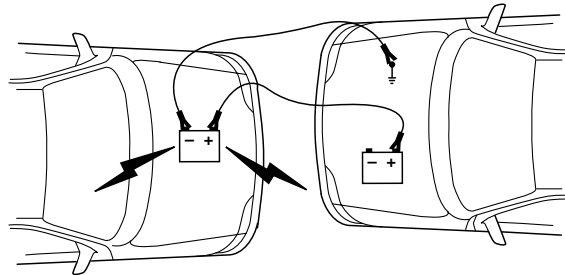

4. Make the final connection of the negative (-) cable to an exposed metal part of the stalled vehicle's engine, away from the battery and the carburetor/fuel injection system. **Do not** use fuel lines, engine rocker covers or the intake manifold as *grounding* points.



Do not connect the end of the second cable to the negative (-) terminal of the battery to be jumped. A spark may cause an explosion of the gases that surround the battery.

5. Ensure that the cables are clear of fan blades, belts, moving parts of both engines, or any fuel delivery system parts.

Jump starting

1. Start the engine of the booster vehicle and run the engine at moderately increased speed.
2. Start the engine of the disabled vehicle.
3. Once the disabled vehicle has been started, run both engines for an additional three minutes before disconnecting the jumper cables.

Roadside Emergencies

Removing the jumper cables

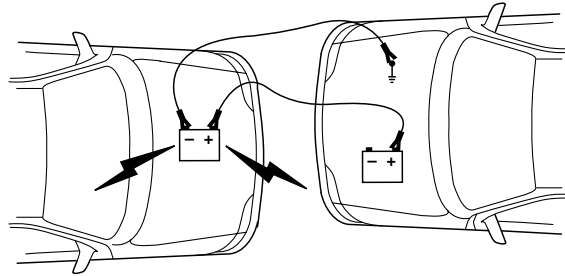

Remove the jumper cables in the reverse order that they were connected.

1. Remove the jumper cable from the *ground* metal surface.

Note: In the illustrations, *lightning bolts* are used to designate the assisting (boosting) battery.

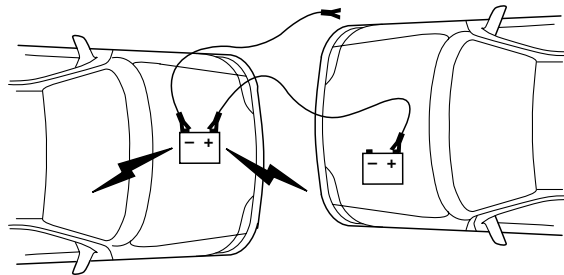

2. Remove the jumper cable on the negative (-) connection of the booster vehicle's battery.

Roadside Emergencies

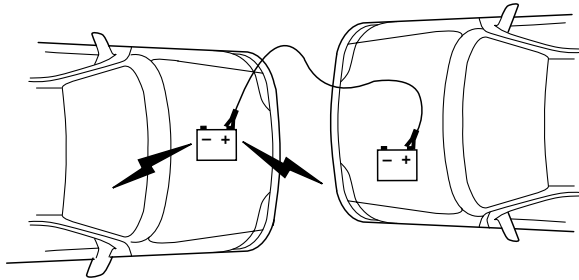

3. Remove the jumper cable from the positive (+) terminal of the booster vehicle's battery.

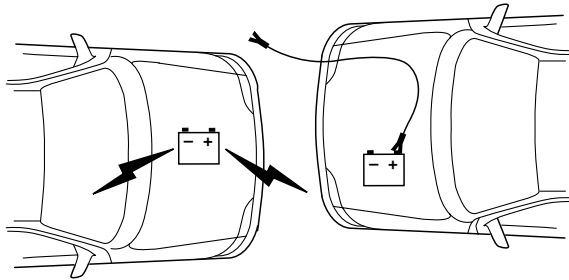

4. Remove the jumper cable from the positive (+) terminal of the disabled vehicle's battery.

After the disabled vehicle has been started and the jumper cables removed, allow it to idle for several minutes so the engine computer can *relearn* its idle conditions.

Roadside Emergencies

WRECKER TOWING

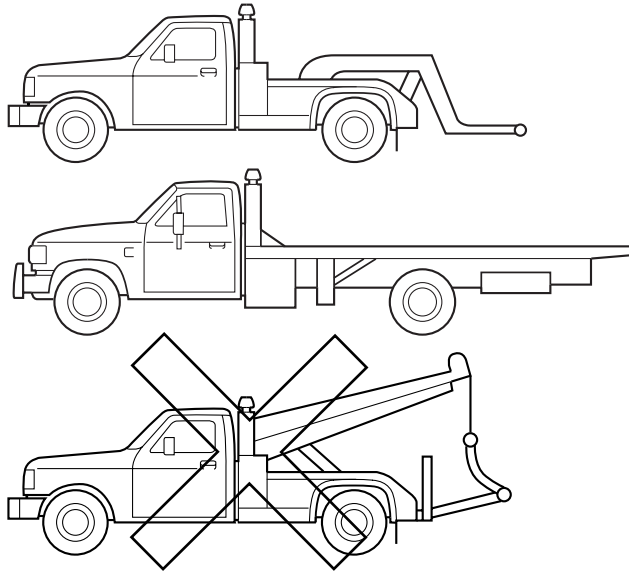

If you need to have your vehicle towed, contact a professional towing service or, if you are a member of a roadside assistance program, your roadside assistance service provider.

Ford recommends your vehicle be towed with a wheel lift or flatbed. Do not tow with a slingbelt. Ford Motor Company has not approved a slingbelt towing procedure.

On 4x2 vehicles, it is acceptable to tow the vehicle with the front wheels on the ground (without dollies) and the rear wheels off the ground.

On 4x4 vehicles, it is recommended that your vehicle be towed with a wheel lift and dollies or flatbed equipment with all the wheels off the ground.

If the vehicle is towed by other means or incorrectly, vehicle damage may occur.

Customer Assistance

GETTING THE SERVICES YOU NEED

At home

You must take your Ford vehicle to an authorized dealer for warranty repairs. While any authorized dealer handling your vehicle line will provide warranty service, we recommend you return to your selling authorized dealer who wants to ensure your continued satisfaction. Please note that certain warranty repairs require special training and/or equipment, so not all authorized dealers are authorized to perform all warranty repairs. This means that, depending on the warranty repair needed, you may have to take your vehicle to another authorized dealer. A reasonable time must be allowed to perform a repair after taking your vehicle to the authorized dealer. Repairs will be made using Ford or Motorcraft parts, or remanufactured or other parts that are authorized by Ford.

If you have questions or concerns, or are unsatisfied with the service you are receiving, follow these steps:

1. Contact your Sales Representative or Service Advisor at your selling/servicing authorized dealer.
2. If your inquiry or concern remains unresolved, contact the Sales Manager, Service Manager or Customer Relations Manager.
3. If you require assistance or clarification on Ford Motor Company policies or procedures, please contact the Ford Customer Relationship Center at 1-800-392-3673 (FORD).

Away from home

If you own a Ford or Mercury vehicle and are away from home when your vehicle needs service, or if you need more help than the authorized dealer could provide, after following the steps described above, contact the Ford Customer Relationship Center to find an authorized dealer to help you.

In the United States:

Ford Motor Company
Customer Relationship Center
P.O. Box 6248
Dearborn, MI 48121
1-800-392-3673 (FORD)
(TDD for the hearing impaired: 1-800-232-5952)
www.customersaskford.com

266

Customer Assistance

In Canada:
Customer Relationship Centre
Ford Motor Company of Canada, Limited
P.O. Box 2000
Oakville, Ontario L6J 5E4
1-800-565-3673 (FORD)
www.ford.ca

If you own a Lincoln vehicle and are away from home when your vehicle needs service, or if you need more help than the authorized dealer could provide, after following the steps described above, contact the Ford Customer Relationship Center to find an authorized dealer to help you.

In the United States:
Ford Motor Company
Customer Relationship Center
P.O. Box 6248
Dearborn, MI 48121
1-800-521-4140
(TDD for the hearing impaired: 1-800-232-5952)
www.customersaskford.com

In Canada:
Lincoln Centre
Ford Motor Company of Canada, Limited
P.O. Box 2000
Oakville, Ontario L6J 5E4
1-800-387-9333
www.lincolncanada.com

In order to help you service your Lincoln vehicle, please have the following information available when contacting the Lincoln Centre:

- Your telephone number (home and business)
- The name of the authorized dealer and the city where the authorized dealer is located
- The year and make of your vehicle
- The date of vehicle purchase
- The current odometer reading
- The vehicle identification number (VIN)

Additional Assistance

If you still have a complaint involving a warranty dispute, you may wish to contact the Better Business Bureau (BBB) AUTO LINE program (U.S. only).

Customer Assistance

In some states (in the U.S.) you must directly notify Ford in writing before pursuing remedies under your state's warranty laws. Ford is also allowed a final repair attempt in some states.

In the United States, a warranty dispute must be submitted to the BBB AUTO LINE before taking action under the Magnuson-Moss Warranty Act, or to the extent allowed by state law, before pursuing replacement or repurchase remedies provided by certain state laws. This dispute handling procedure is not required prior to enforcing state created rights or other rights which are independent of the Magnuson-Moss Warranty Act or state replacement or repurchase laws.

IN CALIFORNIA (U.S. ONLY)

California Civil Code Section 1793.2(d) requires that, if a manufacturer or its representative is unable to repair a motor vehicle to conform to the vehicle's applicable express warranty after a reasonable number of attempts, the manufacturer shall be required to either replace the vehicle with one substantially identical or repurchase the vehicle and reimburse the buyer in an amount equal to the actual price paid or payable by the consumer (less a reasonable allowance for consumer use). The consumer has the right to choose whether to receive a refund or replacement vehicle.

California Civil Code Section 1793.22(b) presumes that the manufacturer has had a reasonable number of attempts to conform the vehicle to its applicable express warranties if, within the first 18 months of ownership of a new vehicle or the first 18,000 miles (29,000 km), whichever occurs first:

1. Two or more repair attempts are made on the same non-conformity likely to cause death or serious bodily injury OR
2. Four or more repair attempts are made on the same nonconformity (a defect or condition that substantially impairs the use, value or safety of the vehicle) OR
3. The vehicle is out of service for repair of nonconformities for a total of more than 30 calendar days (not necessarily all at one time)

In the case of 1 or 2 above, the consumer must also notify the manufacturer of the need for the repair of the nonconformity at the following address:

Ford Motor Company
16800 Executive Plaza Drive
Mail Drop 3NE-B
Dearborn, MI 48126

268

Customer Assistance

THE BETTER BUSINESS BUREAU (BBB) AUTO LINE PROGRAM (U.S. ONLY)

Your satisfaction is important to Ford Motor Company and to your dealer. Experience has shown that our customers have been very successful in achieving satisfaction by following the three-step procedure outlined on the front page of the Warranty Guide. However, if your warranty concern has not been resolved using the three-step procedure, you may be eligible to participate in the BBB AUTO LINE program.

The BBB AUTO LINE program consists of two parts – mediation and arbitration. Initially, the BBB will try to resolve your question or concern through mediation. Mediation is a process through which a representative of the BBB will contact the parties and explore options for settlement of your claim. If mediation is not successful, customers with eligible claims may participate in the BBB AUTO LINE arbitration process. An arbitration hearing will be scheduled so that you can present your case in an informal setting before an impartial person. The arbitrator will consider the testimony provided and make a decision after the hearing. You are not bound by the decision but may choose to accept it. If you choose to accept the BBB AUTO LINE decision then Ford must abide by the accepted decision as well. If the arbitrator has decided in your favor and you accept the decision, the BBB AUTO LINE program will contact you to ensure that Ford has complied with the decision in a timely manner. Disputes submitted to the BBB AUTO LINE program are usually decided within forty days after you file your claim with the BBB.

To initiate a claim with the BBB AUTO LINE, you will be asked for your name and address, general information about your new vehicle, information about your warranty concerns and any steps you have already taken to try to resolve them. You will then be mailed a Customer Claim Form for which the customer will need to complete, provide proof of vehicle ownership, sign and return the Customer Claim Form to the BBB. Upon receipt, the BBB will review the claim for eligibility under the Program Summary Guidelines.

You can get more information by calling BBB AUTO LINE at 1-800-955-5100, or writing to:

BBB AUTO LINE
4200 Wilson Boulevard, Suite 800
Arlington, Virginia 22203-1833

Note: Ford Motor Company reserves the right to change eligibility limitations, modify procedures, or to discontinue this process at any time without notice and without obligation.

Customer Assistance

UTILIZING THE MEDIATION/ARBITRATION PROGRAM (CANADA ONLY)

For vehicles delivered to authorized Canadian dealers. In those cases where you continue to feel that the efforts by Ford of Canada and the authorized dealer to resolve a factory-related vehicle service concern have been unsatisfactory, Ford of Canada participates in an impartial third party mediation/arbitration program administered by the Canadian Motor Vehicle Arbitration Plan (CAMVAP).

The CAMVAP program is a straight-forward and relatively speedy alternative to resolve a disagreement when all other efforts to produce a settlement have failed. This procedure is without cost to you and is designed to eliminate the need for lengthy and expensive legal proceedings.

In the CAMVAP program, impartial third-party arbitrators conduct hearings at mutually convenient times and places in an informal environment. These impartial arbitrators review the positions of the parties, make decisions and, when appropriate, render awards to resolve disputes. CAMVAP decisions are fast, fair, and final as the arbitrator's award is binding both to you and Ford of Canada.

CAMVAP services are available in all territories and provinces. For more information, without charge or obligation, call your CAMVAP Provincial Administrator directly at 1-800-207-0685.

FORD EXTENDED SERVICE PLAN

You can get more protection for your new car or light truck by purchasing Ford Extended Service Plan (Ford ESP) coverage. It provides the following:

- Benefits during the warranty period depending on the plan you purchase (such as: reimbursement for rentals; coverage for certain maintenance and wear items).
- Protection against covered repair costs after your Bumper-to-Bumper Warranty expires.

You may purchase Ford ESP from any participating authorized dealer. There are several plans available in various time, distance and deductible combinations which can be tailored to fit your own driving needs. Ford ESP also offers reimbursement benefits for towing and rental coverage.

When you buy Ford ESP, you receive Peace-of-Mind protection throughout the United States and Canada, provided by a network of more than 4,600 participating authorized dealers.

270

Customer Assistance

If you did not take advantage of the Ford Extended Service Plan at the time of purchasing your vehicle, you may still be eligible. Since this information is subject to change, please ask your authorized dealer for complete details about Ford Extended Service Plan coverage options, or visit the Ford ESP website at www.ford-esp.com.

GETTING ASSISTANCE OUTSIDE THE U.S. AND CANADA

Before exporting your vehicle to a foreign country, contact the appropriate foreign embassy or consulate. These officials can inform you of local vehicle registration regulations and where to find unleaded fuel.

If you cannot find unleaded fuel or can only get fuel with an anti-knock index lower than is recommended for your vehicle, contact a regional office or owner relations/customer relationship office.

The use of leaded fuel in your vehicle without proper conversion may damage the effectiveness of your emission control system and may cause engine knocking or serious engine damage. Ford Motor Company/Ford of Canada is not responsible for any damage caused by use of improper fuel. Using leaded fuel may also result in difficulty importing your vehicle back into the U.S.

If your vehicle must be serviced while you are traveling or living in Central America, the Caribbean, or the Middle East, contact the nearest authorized dealer. If the authorized dealer cannot help you, write or call:

FORD MOTOR COMPANY
FORD EXPORT OPERATIONS
1555 Fairlane Drive
Fairlane Business Park #3
Allen Park, Michigan 48101
U.S.A.
Telephone: (313) 594-4857
FAX: (313) 390-0804

If you are in another foreign country, contact the nearest authorized dealer. If the authorized dealer employees cannot help you, they can direct you to the nearest Ford affiliate office.

If you buy your vehicle in North America and then relocate outside of the U.S. or Canada, register your vehicle identification number (VIN) and new address with Ford Motor Company Export Operations.

Customers in the U.S. should call 1-800-392-3673.

Customer Assistance

ORDERING ADDITIONAL OWNER'S LITERATURE

To order the publications in this portfolio, contact Helm, Incorporated at:

HELM, INCORPORATED
P.O. Box 07150
Detroit, Michigan 48207

Or call:

For a free publication catalog, order toll free: 1-800-782-4356

Monday-Friday 8:00 a.m. - 6:00 p.m. EST

Helm, Incorporated can also be reached by their website:
www.helminc.com.

(Items in this catalog may be purchased by credit card, check or money order.)

Obtaining a French owner's guide

French Owner's Guides can be obtained from your authorized dealer or by writing to Ford Motor Company of Canada, Limited, Service Publications, P.O. Box 1580, Station B, Mississauga, Ontario L4Y 4G3.

REPORTING SAFETY DEFECTS (U.S. ONLY)

If you believe that your vehicle has a defect which could cause a crash or could cause injury or death, you should immediately inform the National Highway Traffic Safety Administration (NHTSA) in addition to notifying Ford Motor Company.



If NHTSA receives similar complaints, it may open an investigation, and if it finds that a safety defect exists in a group of vehicles, it may order a recall and remedy campaign. However, NHTSA cannot become involved in individual problems between you, your dealer, or Ford Motor Company.

To contact NHTSA, you may call the Vehicle Safety Hotline toll-free at 1-888-327-4236 (TTY: 1-800-424-9153); go to <http://www.safercar.gov>; or write to:

Administrator
NHTSA
400 Seventh Street, SW
Washington, D.C. 20590

You can also obtain other information about motor vehicle safety from <http://www.safercar.gov>.

272

2007 F-150 (f12)
Owners Guide (post-2002-fmt)
USA (fus)

WASHING THE EXTERIOR

Wash your vehicle regularly with cool or lukewarm water and a neutral pH shampoo, such as Motorcraft Detail Wash (ZC-3-A), which is available from your authorized dealer.

- Never use strong household detergents or soap, such as dish washing or laundry liquid. These products can discolor and spot painted surfaces.
- Never wash a vehicle that is “hot to the touch” or during exposure to strong, direct sunlight.
- Always use a clean sponge or car wash mitt with plenty of water for best results.
- Dry the vehicle with a chamois or soft terry cloth towel in order to eliminate water spotting.
- It is especially important to wash the vehicle regularly during the winter months, as dirt and road salt are difficult to remove and cause damage to the vehicle.
- Immediately remove items such as gasoline, diesel fuel, bird droppings and insect deposits because they can cause damage to the vehicle’s paintwork and trim over time.
- Remove any exterior accessories, such as antennas, before entering a car wash.
- **Suntan lotions and insect repellents can damage any painted surface; if these substances come in contact with your vehicle, wash off as soon as possible.**
- **If your vehicle is equipped with running boards, do not use rubber, plastic and vinyl protectant products on the running board surface, as the area may become slippery.**

Exterior chrome

- Wash the vehicle first, using cool or lukewarm water and a neutral pH shampoo, such as Motorcraft Detail Wash (ZC-3-A).
- Use Custom Brite Metal Cleaner (ZC-15), available from your authorized dealer. Apply the product as you would a wax to clean bumpers and other chrome parts; allow the cleaner to dry for a few minutes, then wipe off the haze with a clean, dry rag.
- **Never use abrasive materials such as steel wool or plastic pads as they can scratch the chrome surface.**

WAXING

Applying Motorcraft Paint Sealant (ZC-45) to your vehicle every six months will assist in reducing minor scratches and paint damage.

Cleaning

- Wash the vehicle first.
- Do not use waxes that contain abrasives; use Motorcraft Premium Liquid Wax (ZC-53-A), which is available from your authorized dealer, or an equivalent quality product.
- Do not allow paint sealant to come in contact with any non-body (low-gloss black) colored trim, such as grained door handles, roof racks, bumpers, side moldings, mirror housings or the windshield cowl area. The paint sealant will “gray” or stain the parts over time.

PAINT CHIPS

Your authorized dealer has touch-up paint and sprays to match your vehicle's color. Take your color code (printed on a sticker in the driver's door jamb) to your authorized dealer to ensure you get the correct color.

- Remove particles such as bird droppings, tree sap, insect deposits, tar spots, road salt and industrial fallout before repairing paint chips.
- Always read the instructions before using the products.

ALUMINUM WHEELS AND WHEEL COVERS

Aluminum wheels and wheel covers are coated with a clearcoat paint finish. In order to maintain their shine:

- Clean weekly with Motorcraft Wheel and Tire Cleaner (ZC-37-A), which is available from your authorized dealer. Heavy dirt and brake dust accumulation may require agitation with a sponge. Rinse thoroughly with a strong stream of water.
- Never apply any cleaning chemical to hot or warm wheel rims or covers.
- Some automatic car washes may cause damage to the finish on your wheel rims or covers. Chemical-strength cleaners, or cleaning chemicals, in combination with brush agitation to remove brake dust and dirt, could wear away the clearcoat finish over time.
- Do not use hydrofluoric acid-based or high caustic-based wheel cleaners, steel wool, fuels or strong household detergent.
- To remove tar and grease, use Motorcraft Bug and Tar Remover (ZC-42), available from your authorized dealer.

Cleaning

ENGINE

Engines are more efficient when they are clean because grease and dirt buildup keep the engine warmer than normal. When washing:

- Take care when using a power washer to clean the engine. The high-pressure fluid could penetrate the sealed parts and cause damage.
- Do not spray a hot engine with cold water to avoid cracking the engine block or other engine components.
- Spray Motorcraft Engine Shampoo and Degreaser (ZC-20) on all parts that require cleaning and pressure rinse clean.
- Cover the highlighted areas to prevent water damage when cleaning the engine.

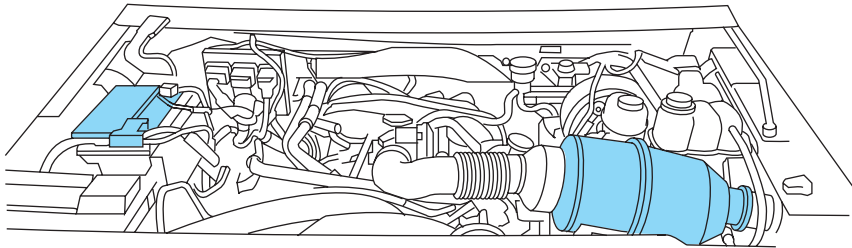

- **4.2L engine**

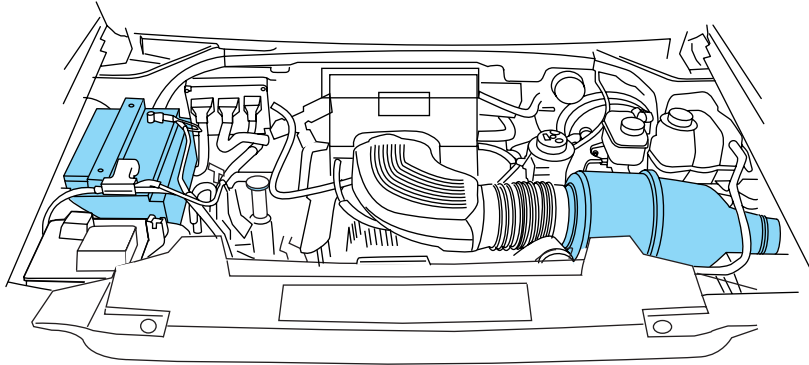

- **4.6L engine**

Cleaning

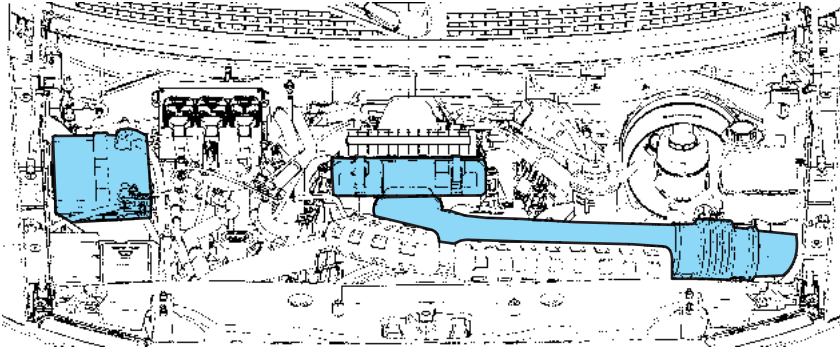

- **5.4L engine**
- Never wash or rinse the engine while it is running; water in the running engine may cause internal damage.

PLASTIC (NON-PAINTED) EXTERIOR PARTS

Use only approved products to clean plastic parts. These products are available from your authorized dealer.

- For routine cleaning, use Motorcraft Detail Wash (ZC-3-A).
- If tar or grease spots are present, use Motorcraft Bug and Tar Remover (ZC-42).
- For plastic headlamp lenses, use Motorcraft Ultra Clear Spray Glass Cleaner (ZC-23).

WINDOWS AND WIPER BLADES

The windshield, rear and side windows and the wiper blades should be cleaned regularly. If the wipers do not wipe properly, substances on the vehicle's glass or the wiper blades may be the cause. These may include hot wax treatments used by commercial car washes, water repellent coatings, tree sap, or other organic contamination; these contaminants may cause squeaking or chatter noise from the blades, and streaking and smearing of the windshield. To clean these items, follow these tips:

- The windshield, rear windows and side windows may be cleaned with a non-abrasive cleaner such as Motorcraft Ultra-Clear Spray Glass Cleaner (ZC-23), available from your authorized dealer.

Cleaning

- The wiper blades can be cleaned with isopropyl (rubbing) alcohol or Motorcraft Premium Windshield Washer Concentrate (ZC-32-A), available from your authorized dealer. This washer fluid contains special solution in addition to alcohol which helps to remove the hot wax deposited on the wiper blade and windshield from automated car wash facilities. Be sure to replace wiper blades when they appear worn or do not function properly.
- Do not use abrasives, as they may cause scratches.
- Do not use fuel, kerosene, or paint thinner to clean any parts.

If you cannot remove those streaks after cleaning with the glass cleaner or if the wipers chatter and move in a jerky motion, clean the outer surface of the windshield and the wiper blades using a sponge or soft cloth with a neutral detergent or mild-abrasive cleaning solution. After cleaning, rinse the windshield and wiper blades with clean water. The windshield is clean if beads do not form when you rinse the windshield with water.

Do not use sharp objects, such as a razor blade, to clean the inside of the rear window or to remove decals, as it may cause damage to the rear window defroster's heated grid lines (if equipped).

INSTRUMENT PANEL

Clean the instrument panel with a damp cloth, then with a clean, dry cloth, or use Motorcraft Dash & Vinyl Cleaner (ZC-38-A).

- Avoid cleaners or polish that increase the gloss of the upper portion of the instrument panel. The dull finish in this area helps protect the driver from undesirable windshield reflection.



Do not use chemical solvents or strong detergents when cleaning the steering wheel or instrument panel to avoid contamination of the airbag system.

- Be certain to wash or wipe your hands clean if you have been in contact with certain products such as insect repellent and suntan lotion in order to avoid possible damage to the interior painted surfaces.

Cleaning

INSTRUMENT PANEL AND CONSOLE (HARLEY-DAVIDSON EDITION ONLY)

Your vehicle's instrument panel and console are uniquely painted with both high and low gloss paints that require special care. The high gloss area is similar to that of the vehicle's exterior; the low gloss area is designed to help protect the driver from undesirable windshield reflection.

High gloss paint area

In order to maintain the finish of the instrument panel and console, the high gloss areas should be treated similar to the that of exterior paint or glossy plastic surfaces. When cleaning the high gloss areas:

- **Do not use** paper towels or newspaper.
- **Do not use** silicone or Teflon-based products.

Dust the high gloss areas with a clean, dry cloth, or use Motorcraft Dusting Cloth (ZC-24 or ZC-25) or Motorcraft Dusting Cloth Mitts (ZC-47).

For general cleaning, use mild, soapy water and a soft, damp cloth, then dry with a clean, dry cloth, or use or use Motorcraft Dash & Vinyl Cleaner (ZC-38-A) or Motorcraft Ultra-Clear Spray Glass Cleaner (ZC-23).

For removal of fine scuffs and scratches, use Scotch-Brite® Microfiber Cloth or cheese cloth along with Motorcraft Premium Liquid Wax (ZC-53-A), Motorcraft Paint Sealant (ZC-45), or Motorcraft Custom Clear Coat Polish (ZC-8-A). **Note:** Removal of deep scuffs and scratches should be performed by an authorized dealer or an experienced repair facility.

Low gloss paint area

The low gloss area of the instrument panel's upper dash should be cleaned with mild, soapy water and a soft, damp cloth, or Motorcraft Dash & Vinyl Cleaner (ZC-38-A), then dried with a clean, dry cloth. When cleaning the low gloss areas:

- **Do not use** paper towels or newspaper.
- **Do not use** silicone or Teflon-based products.
- **Do not use** exterior paint waxes or sealants.

Dust the low gloss areas with a clean, dry cloth, or use Motorcraft Dusting Cloth (ZC-24 or ZC-25) or Motorcraft Dusting Cloth Mitts (ZC-47).

Cleaning

INTERIOR TRIM

- Clean the interior trim areas with a damp cloth, then with a clean, dry cloth; you may also use Motorcraft Dash & Vinyl Cleaner (ZC-38-A).
- Do not use household or glass cleaners as these may damage the finish.

INTERIOR

For fabric, carpets, cloth seats and safety belts:

- Remove dust and loose dirt with a vacuum cleaner.
- Remove light stains and soil with Motorcraft Professional Strength Carpet & Upholstery Cleaner (ZC-54).
- If grease or tar is present on the material, spot-clean the area first with Motorcraft Spot and Stain Remover (ZC-14).
- If a ring forms on the fabric after spot cleaning, clean the entire area immediately (but do not oversaturate) or the ring will set.
- Do not use household cleaning products or glass cleaners, which can stain and discolor the fabric and affect the flame retardant abilities of the seat materials.



Do not use cleaning solvents, bleach or dye on the vehicle's seatbelts, as these actions may weaken the belt webbing.

LEATHER SEATS (IF EQUIPPED, EXCEPT FOR THE KING RANCH SUPERCREW)

Your leather seating surfaces have a clear, protective coating over the leather.

For King Ranch SuperCrew leather seats, refer to separate section in this chapter.

- To clean, use a soft cloth with Motorcraft Deluxe Leather and Vinyl Cleaner (ZC-11-A). Dry the area with a soft cloth.
- To help maintain its resiliency and color, use the Motorcraft Deluxe Leather Care Kit (ZC-11-D), available from your authorized dealer.
- Do not use household cleaning products, alcohol solutions, solvents or cleaners intended for rubber, vinyl and plastics, or oil/petroleum-based leather conditioners. These products may cause premature wearing of the clear, protective coating.

Note: In some instances, color or dye transfer can occur when wet clothing comes in contact with leather upholstery. If this occurs, the leather should be cleaned immediately to avoid permanent staining.

Cleaning

Leather seats for the King Ranch SuperCrew only (if equipped)

Your vehicle is equipped with seating covered in premium, top-grain leather which is extremely durable, but still requires special care and maintenance in order to ensure longevity and comfort.

Regular cleaning and conditioning will maintain the appearance of the leather. Failure to care for the leather can result in drying out and fading of the material.

Note: In some instances, color or dye transfer can occur when wet clothing comes in contact with leather upholstery. If this occurs, the leather should be cleaned immediately to avoid permanent staining.

Cleaning

For dirt, use a vacuum cleaner then use a clean, damp cloth or soft brush.

For routine cleaning, wipe the surface with a soft, damp cloth. For more thorough cleaning, wipe the surface with a mild soap. If the leather cannot be completely cleaned using a mild soap and water solution, the leather may be cleaned using a commercially available cleaning product "Tanners Preserve Leather Cleaner" and a 3M "Type T" scrubbing pad.

- Clean spills as quickly as possible.
- Test any cleaner or stain remover on an inconspicuous part of the leather as cleaners may darken the leather. For more specific cleaning information, contact the King Ranch Saddle Shop at 1-800-282-KING (5464).
- Do not spill coffee, ketchup, mustard, orange juice or oil-based products on the leather as they may permanently stain the leather.
- Do not use household cleaning products, alcohol solutions, solvents or cleaners intended for rubber, vinyl or plastics.

Scratches

Natural Markings - Because the leather in the seat comes from genuine steer hides, there will be evidence of naturally occurring markings, such as small scars. These markings give character to the seating covers and should be considered as proof of a genuine leather product.

In order to lessen the appearance of certain scratches and other wear marks, apply conditioner on the affected area following the same instructions as in the *Conditioning* section.

Cleaning

Conditioning

Bottles of King Ranch Leather Conditioner are available at the King Ranch Saddle Shop. Visit the Web site at *www.krsaddleshop.com*, or telephone (in the United States) 1-800-282-KING (5464). If you are unable to obtain King Ranch Leather Conditioner, use another premium leather conditioner.

- Apply your first conditioning treatment within six months of taking delivery of your vehicle. Condition twice yearly in order to replenish lost oils and revitalize the aroma, suppleness and resilience of the leather.
- Clean the surfaces using the steps outlined in the *Cleaning* section.
- Ensure the leather is dry then apply a nickel-sized amount of conditioner to a clean, dry cloth
- Rub the conditioner into leather until it disappears. Allow the conditioner to dry and repeat the process for the entire interior. If a film appears, wipe off film with a dry, clean cloth.

UNDERBODY

Flush the complete underside of your vehicle frequently. Keep body and door drain holes free from packed dirt.

FORD AND LINCOLN MERCURY CAR CARE PRODUCTS

Your Ford or Lincoln Mercury authorized dealer has many quality products available to clean your vehicle and protect its finishes. These quality products have been specifically engineered to fulfill your automotive needs; they are custom designed to complement the style and appearance of your vehicle. Each product is made from high quality materials that meet or exceed rigid specifications. For best results, use the following products or products of equivalent quality:

Motorcraft Bug and Tar Remover (ZC-42)

Motorcraft Car Care Kit (ZC-26)

Motorcraft Car Wash (Canada only) (CXC-21)

Motorcraft Custom Bright Metal Cleaner (ZC-15)

Motorcraft Custom Clear Coat Polish (ZC-8-A)

Motorcraft Custom Vinyl Protectant (U.S. only) (ZC-40-A)

Motorcraft Dash and Vinyl Cleaner (ZC-38-A)

Motorcraft Deluxe Leather and Vinyl Cleaner (U.S. only) (ZC-11-A)

Cleaning

Motorcraft Detail Wash (ZC-3-A)
Motorcraft Dusting Cloth (ZC-24)
Motorcraft Engine Shampoo and Degreaser (U.S. only) (ZC-20)
Motorcraft Engine Shampoo (Canada only) (CXC-66-A)
Motorcraft One Step Wash and Wax Concentrate (ZC-6-A)
Motorcraft Paint Sealant (ZC-45)
Motorcraft Premium Car Wash Concentrate (U.S. only) (ZC-17-B)
Motorcraft Premium Glass Cleaner (Canada only) (CXC-100)
Motorcraft Premium Liquid Wax (ZC-53-A)
Motorcraft Premium Windshield Washer Concentrate (ZC-32-A)
Motorcraft Professional Strength Carpet & Upholstery Cleaner (ZC-54)
Motorcraft Spot and Stain Remover (U.S. only) (ZC-14)
Motorcraft Tire Clean and Shine (ZC-28)
Motorcraft Triple Clean (U.S. only) (ZC-13)
Motorcraft Ultra-Clear Spray Glass Cleaner (ZC-23)
Motorcraft Vinyl Cleaner (Canada only) (CXC-93)
Motorcraft Wheel and Tire Cleaner (ZC-37-A)

Maintenance and Specifications

SERVICE RECOMMENDATIONS

To help you service your vehicle, we provide *scheduled maintenance information* which makes tracking routine service easy.

If your vehicle requires professional service, your authorized dealer can provide the necessary parts and service. Check your *Warranty Guide/Owner Information Guide* to find out which parts and services are covered.

Use only recommended fuels, lubricants, fluids and service parts conforming to specifications. Motorcraft parts are designed and built to provide the best performance in your vehicle.

PRECAUTIONS WHEN SERVICING YOUR VEHICLE

- Do not work on a hot engine.
- Make sure that nothing gets caught in moving parts.
- Do not work on a vehicle with the engine running in an enclosed space, unless you are sure you have enough ventilation.
- Keep all open flames and other burning (cigarettes) material away from the battery and all fuel related parts.

Working with the engine off

- Automatic transmission:
 1. Set the parking brake and shift to P (Park).
 2. Turn off the engine and remove the key.
 3. Block the wheels.
- Manual transmission:
 1. Set the parking brake, depress the clutch and place the gearshift in 1 (First).
 2. Turn off the engine and remove the key.
 3. Block the wheels.

Working with the engine on

- Automatic transmission:
 1. Set the parking brake and shift to P (Park).
 2. Block the wheels.
- Manual transmission:
 1. Set the parking brake, depress the clutch and place the gearshift in N (Neutral).
 2. Block the wheels.

Maintenance and Specifications

 To reduce the risk of vehicle damage and/or personal burn injuries do not start your engine with the air cleaner removed and do not remove it while the engine is running.

OPENING THE HOOD

1. Inside the vehicle, pull the hood release handle located under the bottom of the instrument panel.

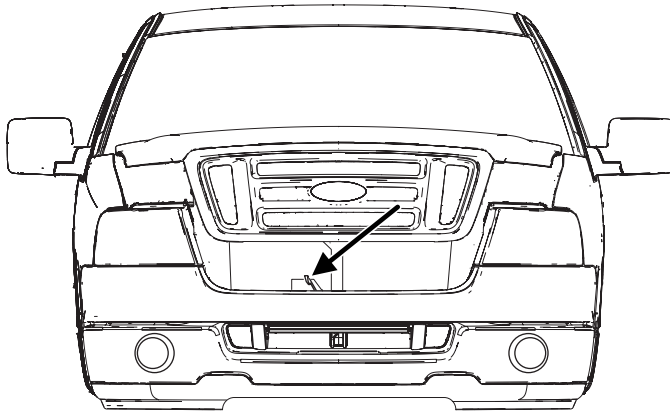
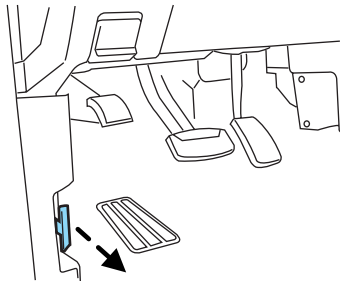

2. Go to the front of the vehicle and release the auxiliary latch that is located on the front bumper under the grill.
3. Lift the hood until the lift cylinders hold it open.

Maintenance and Specifications

IDENTIFYING COMPONENTS IN THE ENGINE COMPARTMENT

4.2L V6 engine

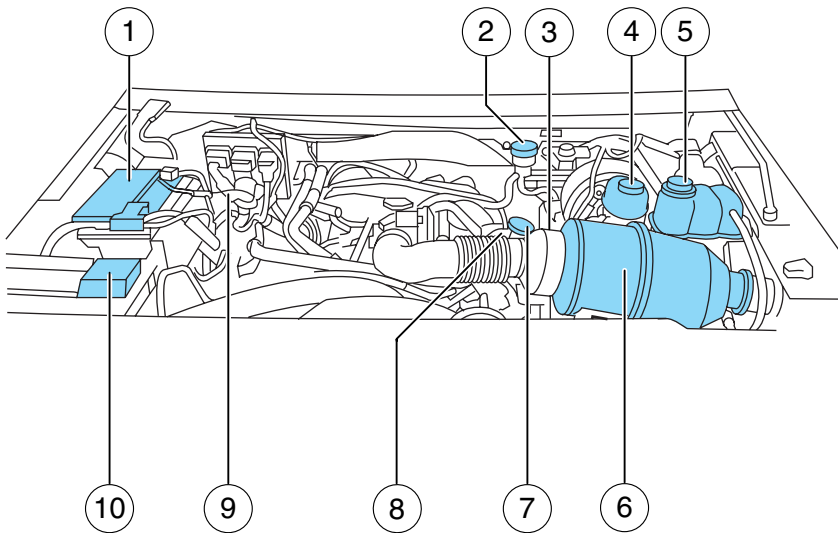

1. Battery
2. Clutch fluid reservoir (manual transmission)
3. Power steering fluid reservoir
4. Brake fluid reservoir
5. Engine coolant reservoir
6. Air filter assembly
7. Engine oil filler cap
8. Engine oil dipstick
9. Transmission fluid dipstick (automatic transmission)
10. Windshield washer fluid reservoir

Maintenance and Specifications

4.6L V8

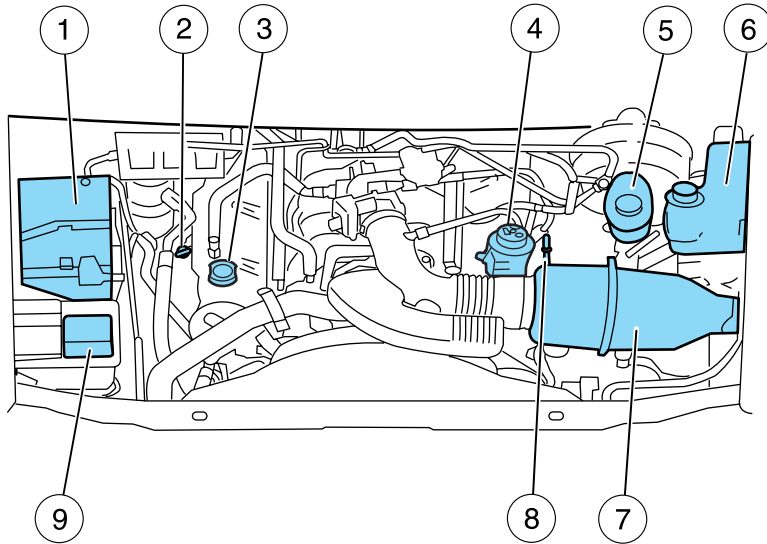

1. Battery
2. Transmission fluid dipstick (automatic transmission)
3. Engine oil filler cap
4. Power steering fluid reservoir
5. Brake fluid reservoir
6. Engine coolant reservoir
7. Air filter assembly
8. Engine oil dipstick
9. Windshield washer fluid reservoir

Maintenance and Specifications

5.4L V8

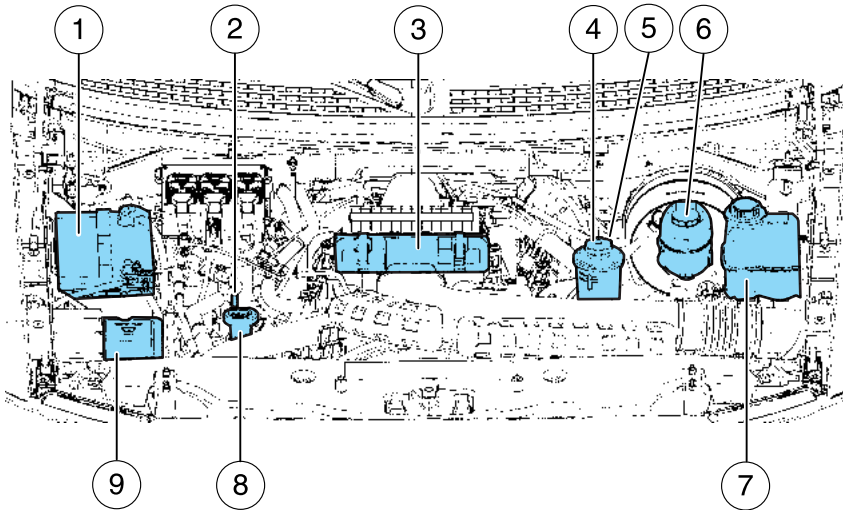

1. Battery
2. Transmission fluid dipstick (automatic transmission)
3. Air filter assembly
4. Power steering fluid reservoir
5. Engine oil dipstick
6. Brake fluid reservoir
7. Engine coolant reservoir
8. Engine oil filler cap
9. Windshield washer fluid reservoir

Maintenance and Specifications

WINDSHIELD WASHER FLUID

Add fluid to fill the reservoir if the level is low. In very cold weather, do not fill the reservoir completely.

Only use a washer fluid that meets Ford specification WSB-M8B16-A2. Do not use any special washer fluid such as windshield water repellent type fluid or bug wash. They may cause squeaking, chatter noise, streaking and smearing. Refer to the *Maintenance product specifications and capacities* section in this chapter.

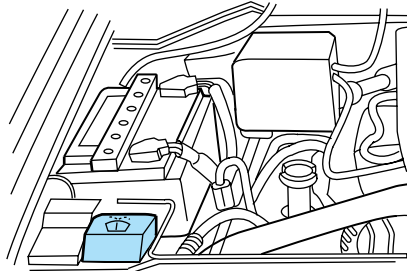

State or local regulations on volatile organic compounds may restrict the use of methanol, a common windshield washer antifreeze additive. Washer fluids containing non-methanol antifreeze agents should be used only if they provide cold weather protection without damaging the vehicle's paint finish, wiper blades or washer system.

 If you operate your vehicle in temperatures below 40° F (4.5°C), use washer fluid with antifreeze protection. Failure to use washer fluid with antifreeze protection in cold weather could result in impaired windshield vision and increase the risk of injury or accident.

Note: Do not put washer fluid in the engine coolant reservoir. Washer fluid placed in the cooling system may harm engine and cooling system components.

CHANGING THE WIPER BLADES

1. Pull the wiper arm away from the vehicle. Turn the blade at an angle from the wiper arm. Push the lock pin manually to release the blade and pull the wiper blade down toward the windshield to remove it from the arm.

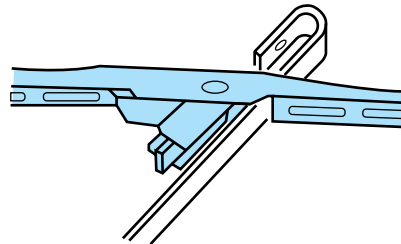

2. Attach the new wiper to the wiper arm and press it into place until a click is heard.

Replace wiper blades at least once per year for optimum performance.

Maintenance and Specifications

Poor wiper quality can be improved by cleaning the wiper blades and the windshield, refer to *Windows and wiper blades* in the *Cleaning* chapter.

To prolong the life of the wiper blades, it is highly recommended to scrape off the ice on the windshield before turning on the wipers. The layer of ice has many sharp edges and can damage the micro edge of the wiper rubber element.

ENGINE OIL

Checking the engine oil

Refer to the *scheduled maintenance information* for the appropriate intervals for checking the engine oil.

1. Make sure the vehicle is on level ground.
2. Turn the engine off and wait a few minutes for the oil to drain into the oil pan.
3. Set the parking brake and ensure the gearshift is securely latched in P (Park) (automatic transmission) or 1 (First) (manual transmission).
4. Open the hood. Protect yourself from engine heat.
 - 4.2L V6 engine

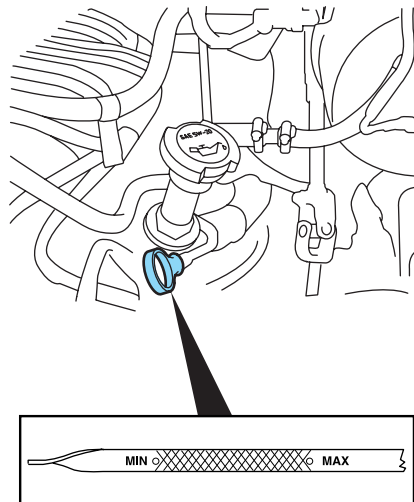

Maintenance and Specifications

- 4.6L/5.4L V8 engine

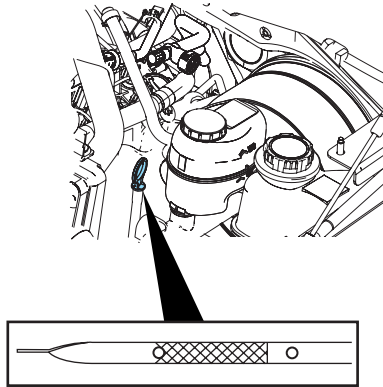

5. Locate and carefully remove the engine oil level indicator (dipstick).
 6. Wipe the indicator clean. Insert the indicator fully, then remove it again.
- If the oil level is **between the lower and upper holes or between the MIN and MAX marks (depending on application)**, the oil level is acceptable. **DO NOT ADD OIL.**

- 4.2L V6 engine

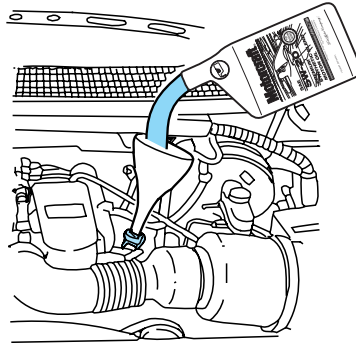

Maintenance and Specifications

- 4.6L/5.4L V8 engine
- If the oil level is below the lower hole or the MIN mark, add enough oil to raise the level within the lower and upper holes or within the MIN-MAX range.

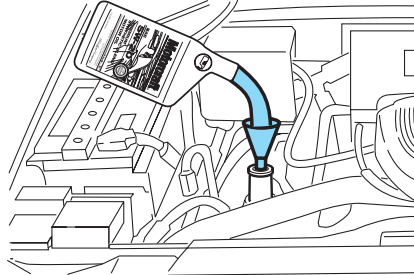

- Oil levels above the upper hole or the MAX mark may cause engine damage. Some oil must be removed from the engine by an authorized dealer.
7. Put the indicator back in and ensure it is fully seated.

Adding engine oil

1. Check the engine oil. For instructions, refer to *Checking the engine oil* in this chapter.
2. If the engine oil level is not within the normal range, add only certified engine oil of the recommended viscosity. Remove the engine oil filler cap and use a funnel to pour the engine oil into the opening.
3. Recheck the engine oil level. Make sure the oil level is not above the normal operating range on the engine oil level indicator (dipstick).
4. Install the indicator and ensure it is fully seated.
5. Fully install the engine oil filler cap by turning the filler cap clockwise 1/4 of a turn until three clicks are heard or until the cap is fully seated.

To avoid possible oil loss, DO NOT operate the vehicle with the engine oil level indicator and/or the engine oil filler cap removed.

Maintenance and Specifications

Engine oil and filter recommendations

Look for this certification trademark.

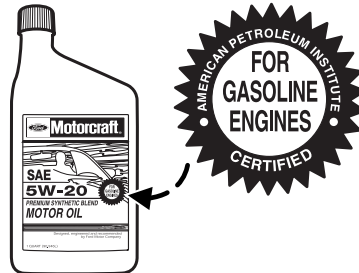

Use SAE 5W-20 engine oil

Only use oils “Certified For Gasoline Engines” by the American Petroleum Institute (API). An oil with this trademark symbol conforms to the current engine and emission system protection standards and fuel economy requirements of the International Lubricant Standardization and Approval Committee (ILSAC), comprised of U.S. and Japanese automobile manufacturers.

To protect your engine’s warranty use Motorcraft SAE 5W-20 or an equivalent SAE 5W-20 oil meeting Ford specification WSS-M2C930-A.

SAE 5W-20 oil provides optimum fuel economy and durability performance meeting all requirements for your vehicle’s engine.

Do not use supplemental engine oil additives, cleaners or other engine treatments. They are unnecessary and could lead to engine damage that is not covered by Ford warranty.

Change your engine oil and filter according to the appropriate schedule listed in *scheduled maintenance information*.

Ford production and aftermarket (Motorcraft) oil filters are designed for added engine protection and long life. If a replacement oil filter is used that does not meet Ford material and design specifications, start-up engine noises or knock may be experienced.

It is recommended you use the appropriate Motorcraft oil filter (or another brand meeting Ford specifications) for your engine application.

Maintenance and Specifications

BATTERY

Your vehicle is equipped with a Motorcraft maintenance-free battery which normally does not require additional water during its life of service.

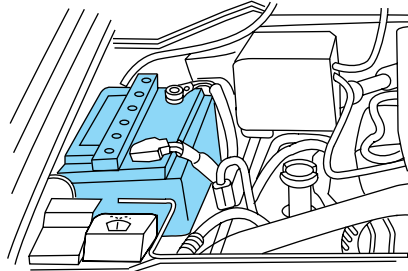

If your battery has a cover/shield, make sure it is reinstalled after the battery has been cleaned or replaced.

For longer, trouble-free operation, keep the top of the battery clean and dry. Also, make certain the battery cables are always tightly fastened to the battery terminals.

If you see any corrosion on the battery or terminals, remove the cables from the terminals and clean with a wire brush. You can neutralize the acid with a solution of baking soda and water.

It is recommended that the negative battery cable terminal be disconnected from the battery if you plan to store your vehicle for an extended period of time. This will minimize the discharge of your battery during storage.



Batteries normally produce explosive gases which can cause personal injury. Therefore, do not allow flames, sparks or lighted substances to come near the battery. When working near the battery, always shield your face and protect your eyes. Always provide proper ventilation.



When lifting a plastic-cased battery, excessive pressure on the end walls could cause acid to flow through the vent caps, resulting in personal injury and/or damage to the vehicle or battery. Lift the battery with a battery carrier or with your hands on opposite corners.

Maintenance and Specifications



Keep batteries out of reach of children. Batteries contain sulfuric acid. Avoid contact with skin, eyes or clothing. Shield your eyes when working near the battery to protect against possible splashing of acid solution. In case of acid contact with skin or eyes, flush immediately with water for a minimum of 15 minutes and get prompt medical attention. If acid is swallowed, call a physician immediately.



Battery posts, terminals and related accessories contain lead and lead compounds. **Wash hands after handling.**

Because your vehicle's engine is also electronically controlled by a computer, some control conditions are maintained by power from the battery. When the battery is disconnected or a new battery is installed, the engine must relearn its idle and fuel trim strategy for optimum driveability and performance. To begin this process:

1. With the vehicle at a complete stop, set the parking brake.
 2. Put the gearshift in P (Park) (automatic transmission) or the neutral position (manual transmission), turn off all accessories and start the engine.
 3. Run the engine until it reaches normal operating temperature.
 4. Allow the engine to idle for at least one minute.
 5. Turn the A/C on and allow the engine to idle for at least one minute.
 6. Drive the vehicle to complete the relearning process.
- The vehicle may need to be driven 10 miles (16 km) or more to relearn the idle and fuel trim strategy.
 - **If you do not allow the engine to relearn its idle trim, the idle quality of your vehicle may be adversely affected until the idle trim is eventually relearned.**

If the battery has been disconnected or a new battery has been installed, the clock and the preset radio stations must be reset once the battery is reconnected.

Maintenance and Specifications

- Always dispose of automotive batteries in a responsible manner. Follow your local authorized standards for disposal. Call your local authorized recycling center to find out more about recycling automotive batteries.

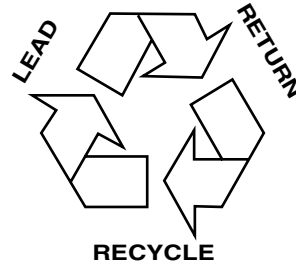

ENGINE COOLANT

Checking engine coolant

The concentration and level of engine coolant should be checked at the intervals listed in *scheduled maintenance information*. The coolant concentration should be maintained at 50/50 coolant and distilled water, which equates to a freeze point of -34°F (-36°C). Coolant concentration testing is possible with a hydrometer or antifreeze tester (such as the Rotunda Battery and Antifreeze Tester, 014-R1060). The level of coolant should be maintained at the "FULL COLD" level or within the "COLD FILL RANGE" in the coolant reservoir. If the level falls below, add coolant per the instructions in the *Adding engine coolant* section.

Your vehicle was factory-filled with a 50/50 engine coolant and water concentration. If the concentration of coolant falls below 40% or above 60%, the engine parts could become damaged or not work properly. **A 50–50 mixture of coolant and water provides the following:**

- **Freeze protection down to -34°F (-36°C).**
- **Boiling protection up to 265°F (129°C).**
- **Protection against rust and other forms of corrosion.**
- **Enables calibrated gauges to work properly.**

Maintenance and Specifications

When the engine is cold, check the level of the engine coolant in the reservoir.

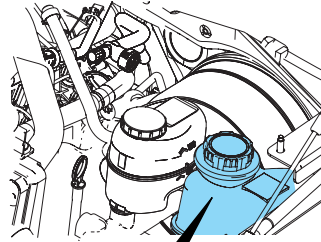

- The engine coolant should be at the “FULL COLD” level or within the “COLD FILL RANGE” as listed on the engine coolant reservoir (depending upon application).
- Refer to *scheduled maintenance information* for service interval schedules.
- Be sure to read and understand *Precautions when servicing your vehicle* in this chapter.

If the engine coolant has not been checked at the recommended interval, the engine coolant reservoir may become low or empty. If the reservoir is low or empty, add engine coolant to the reservoir. Refer to *Adding engine coolant* in this chapter.

Note: Automotive fluids are not interchangeable; do not use engine coolant, antifreeze or windshield washer fluid outside of its specified function and vehicle location.

Adding engine coolant

When adding coolant, make sure it is a 50/50 mixture of engine coolant and distilled water. Add the mixture to the coolant reservoir, **when the engine is cool**, until the appropriate fill level is obtained.



Do not add engine coolant when the engine is hot. Steam and scalding liquids released from a hot cooling system can burn you badly. Also, you can be burned if you spill coolant on hot engine parts.

Maintenance and Specifications



Do not put engine coolant in the windshield washer fluid container. If sprayed on the windshield, engine coolant could make it difficult to see through the windshield.

- **Add Motorcraft Premium Gold Engine Coolant or equivalent meeting Ford specification WSS-M97B51-A1.** Refer to *Maintenance product specifications and capacities* in this chapter.

Note: Use of Motorcraft Cooling System Stop Leak Pellets or an equivalent product meeting Ford specification WSS-M99B37-B6, may darken the color of Motorcraft Premium Gold Engine Coolant from yellow to golden tan.

- **Do not add/mix an orange-colored, extended life coolant such as Motorcraft Specialty Orange Engine Coolant, meeting Ford specification WSS-M97B44-D, with the factory-filled coolant.** Mixing Motorcraft Specialty Orange Engine Coolant or any orange-colored extended life product with your factory filled coolant can result in degraded corrosion protection.
- A large amount of water without engine coolant may be added, in case of emergency, to reach a vehicle service location. In this instance, the cooling system must be drained and refilled with a 50/50 mixture of engine coolant and distilled water as soon as possible. Water alone (without engine coolant) can cause engine damage from corrosion, overheating or freezing.
- **Do not use alcohol, methanol, brine or any engine coolants mixed with alcohol or methanol antifreeze (coolant).** Alcohol and other liquids can cause engine damage from overheating or freezing.
- **Do not add extra inhibitors or additives to the coolant.** These can be harmful and compromise the corrosion protection of the engine coolant.

Add the proper mixture of coolant and water to the “COLD FILL RANGE” or “FULL COLD” level. Follow these steps to add engine coolant.



To reduce the risk of personal injury, make sure the engine is cool before unscrewing the coolant pressure relief cap. The cooling system is under pressure; steam and hot liquid can come out forcefully when the cap is loosened slightly.

1. Before you begin, turn the engine off and let it cool.

Maintenance and Specifications

2. When the engine is cool, wrap a thick cloth around the coolant pressure relief cap on the coolant reservoir (an opaque plastic bottle). Slowly turn cap counterclockwise (left) until pressure begins to release.
3. Step back while the pressure releases.
4. When you are sure that all the pressure has been released, use the cloth to turn it counterclockwise and remove the cap.
5. Fill the coolant reservoir slowly with the proper coolant mixture (see above), to within the “COLD FILL RANGE” or “FULL COLD” level on the reservoir.
6. Replace the cap. Turn until tightly installed. Turn cap until click is heard/felt to ensure it is tightly installed.

After any coolant has been added, check the coolant concentration, refer to the *Checking engine coolant* section. If the concentration is not 50/50 (protection to $-34^{\circ}\text{F}/-36^{\circ}\text{C}$), drain some coolant and adjust the concentration. It may take several drains and additions to obtain a 50/50 coolant concentration.

Whenever coolant has been added, the coolant level in the coolant reservoir should be checked the next few times you drive the vehicle. If necessary, add enough 50/50 concentration of engine coolant and distilled water to bring the liquid level to the proper level.

If you have to add more than 1.0 quart (1.0 liter) of engine coolant per month, have your authorized dealer check the engine cooling system. Your cooling system may have a leak. Operating an engine with a low level of coolant can result in engine overheating and possible engine damage.

Recycled engine coolant

Ford Motor Company does NOT recommend the use of recycled engine coolant in vehicles originally equipped with Motorcraft Premium Gold Engine Coolant since a Ford-approved recycling process is not yet available.



Used engine coolant should be disposed of in an appropriate manner. Follow your community's regulations and standards for recycling and disposing of automotive fluids.

Coolant refill capacity

To find out how much fluid your vehicle's cooling system can hold, refer to *Maintenance product specifications and capacities* in this chapter.

Maintenance and Specifications

Fill your engine coolant reservoir as outlined in *Adding engine coolant* in this section.

Severe climates

If you drive in extremely cold climates (less than -34°F [-36°C]):

- **It may be necessary to increase the coolant concentration above 50%.**
- **NEVER increase the coolant concentration above 60%.**
- **Increased engine coolant concentrations above 60% will decrease the overheat protection characteristics of the engine coolant and may cause engine damage.**
- **Refer to the chart on the coolant container to ensure the coolant concentration in your vehicle will provide adequate freeze protection at the temperatures in which you drive in the winter months.**

If you drive in extremely hot climates:

- **It is still necessary to maintain the coolant concentration above 40%.**
- **NEVER decrease the coolant concentration below 40%.**
- **Decreased engine coolant concentrations below 40% will decrease the corrosion protection characteristics of the engine coolant and may cause engine damage.**
- **Decreased engine coolant concentrations below 40% will decrease the freeze protection characteristics of the engine coolant and may cause engine damage.**
- **Refer to the chart on the coolant container to ensure the coolant concentration in your vehicle will provide adequate protection at the temperatures in which you drive.**

Vehicles driven year-round in non-extreme climates should use a 50/50 mixture of engine coolant and distilled water for optimum cooling system and engine protection.

What you should know about fail-safe cooling (if equipped)

If the engine coolant supply is depleted, this feature allows the vehicle to be driven temporarily before incremental component damage is incurred. The “fail-safe” distance depends on ambient temperatures, vehicle load and terrain.

Maintenance and Specifications

How fail-safe cooling works

If the engine begins to overheat:

- The engine coolant temperature gauge will move to the red (hot) area.
- The mini message center (if equipped) will indicate “Check Gauges”, refer to *Warning Lights and Chimes* in the *Instrument Cluster* chapter.
- The message center (if equipped) will indicate a system warning, refer to *Message Center* in the *Driver Controls* chapter.
- The  light will illuminate.

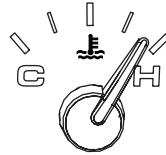

If the engine reaches a preset over-temperature condition, the engine will automatically switch to alternating cylinder operation. Each disabled cylinder acts as an air pump and cools the engine.

When this occurs the vehicle will still operate. However:

- The engine power will be limited.
- The air conditioning system will be disabled.

Continued operation will increase the engine temperature:

- The engine will completely shut down.
- Steering and braking effort will increase.

Once the engine temperature cools, the engine can be re-started. Take your vehicle to an authorized dealer as soon as possible to minimize engine damage.

When fail-safe mode is activated

You have limited engine power when in the fail-safe mode, so drive the vehicle with caution. The vehicle will not be able to maintain high speed operation and the engine will run rough. Remember that the engine is capable of completely shutting down automatically to prevent engine damage, therefore:

1. Pull off the road as soon as safely possible and turn off the engine.
2. Arrange for the vehicle to be taken to an authorized dealer.
3. If this is not possible, wait a short period for the engine to cool.
4. Check the coolant level and replenish if low.

300

Maintenance and Specifications



Never remove the coolant reservoir cap while the engine is running or hot.

5. Restart the engine and take your vehicle to an authorized dealer.

Driving the vehicle without repairing the engine problem increases the chance of engine damage. Take your vehicle to an authorized dealer as soon as possible.

FUEL FILTER

For fuel filter replacement, see your authorized dealer. Refer to *scheduled maintenance information* for the appropriate intervals for changing the fuel filter.

Replace the fuel filter with an authorized Motorcraft part. The customer warranty may be void for any damage to the fuel system if an authorized Motorcraft fuel filter is not used.

WHAT YOU SHOULD KNOW ABOUT AUTOMOTIVE FUELS

Important safety precautions



Do not overfill the fuel tank. The pressure in an overfilled tank may cause leakage and lead to fuel spray and fire.



The fuel system may be under pressure. If the fuel filler cap is venting vapor or if you hear a hissing sound, wait until it stops before completely removing the fuel filler cap. Otherwise, fuel may spray out and injure you or others.



If you do not use the proper fuel filler cap, excessive vacuum in the fuel tank may damage the fuel system or cause the fuel cap to disengage in a collision, which may result in possible personal injury.



Automotive fuels can cause serious injury or death if misused or mishandled.



Fuel ethanol and gasoline may contain benzene, which is a cancer-causing agent.

Maintenance and Specifications

Observe the following guidelines when handling automotive fuel:

- Extinguish all smoking materials and any open flames before fueling your vehicle.
- Always turn off the vehicle before fueling.
- Automotive fuels can be harmful or fatal if swallowed. Fuels such as gasoline and ethanol are highly toxic and if swallowed can cause death or permanent injury. If fuel is swallowed, call a physician immediately, even if no symptoms are immediately apparent. The toxic effects of fuel may not be visible for hours.
- Avoid inhaling fuel vapors. Inhaling too much fuel vapor of any kind can lead to eye and respiratory tract irritation. In severe cases, excessive or prolonged breathing of fuel vapor can cause serious illness and permanent injury.
- Avoid getting fuel liquid in your eyes. If fuel is splashed in the eyes, remove contact lenses (if worn), flush with water for 15 minutes and seek medical attention. Failure to seek proper medical attention could lead to permanent injury.
- Fuels can also be harmful if absorbed through the skin. If fuel is splashed on the skin and/or clothing, promptly remove contaminated clothing and wash skin thoroughly with soap and water. Repeated or prolonged skin contact with fuel liquid or vapor causes skin irritation.
- Be particularly careful if you are taking “Antabuse” or other forms of disulfiram for the treatment of alcoholism. Breathing gasoline and/or ethanol vapors, or skin contact could cause an adverse reaction. In sensitive individuals, serious personal injury or sickness may result. If fuel is splashed on the skin, promptly wash skin thoroughly with soap and water. Consult a physician immediately if you experience an adverse reaction.
- FFV fuel tanks may contain zero to 85 percent ethanol. Any fuel blends containing gasoline and ethanol should be treated the same as “Fuel Ethanol”. To identify if your vehicle is an FFV, check your VIN or the label on the inside of your fuel filler door. When checking the VIN look for the engine type identifier (8th character). If your vehicle is an FFV, then the character will be labeled as a “V”.



Maintenance and Specifications

Pure ethanol is the alcohol which is the intoxicating agent in liquor, beer and wine. It is distilled from the fermentation of plants such as field corn and sugar cane. When ethanol is produced for use in motor fuels, a small amount of gasoline is added to make it unfit for beverage use. The resulting ethanol blend is called denatured fuel ethanol meaning that it is denatured with 2% to 5% gasoline and is suitable for automotive use.

During the summer season, fuel ethanol may contain a maximum of 85% denatured ethanol (Ed85) and 15% unleaded gasoline. The fuel ethanol has a higher octane rating than unleaded regular or premium gasoline and this allows the design of engines with greater efficiency and power.

Winter blends may contain up to 75% denatured ethanol (Ed75) and up to 25% unleaded gasoline to enhance cold engine starts. Severely cold weather may require additional measures for reliable starting. Refer to *Cold Weather Starting* in the *Driving* chapter.

Ethanol is more chemically active than gasoline. It corrodes some metals and causes some plastic and rubber components to swell, break down or become brittle and crack, especially when mixed with gasoline. Special materials and procedures have been developed for flexible fuel vehicles and the dispensers used by ethanol fuel providers.



Flexible fuel components and standard unleaded gasoline fuel components are not interchangeable. If your vehicle is not serviced in accordance with flexible fuel vehicles procedures, damage may occur and your warranty may be invalidated.



When refueling always shut the engine off and never allow sparks or open flames near the filler neck. Never smoke while refueling. Fuel vapor is extremely hazardous under certain conditions. Care should be taken to avoid inhaling excess fumes.



The flow of fuel through a fuel pump nozzle can produce static electricity, which can cause a fire if fuel is pumped into an ungrounded fuel container.

Maintenance and Specifications

Refueling



Fuel vapor burns violently and a fuel fire can cause severe injuries. To help avoid injuries to you and others:

- Read and follow all the instructions on the pump island;
- Turn off your engine when you are refueling;
- Do not smoke if you are near fuel or refueling your vehicle;
- Keep sparks, flames and smoking materials away from fuel;
- Stay outside your vehicle and do not leave the fuel pump unattended when refueling your vehicle — this is against the law in some places;
- Keep children away from the fuel pump; never let children pump fuel.

Use the following guidelines to avoid electrostatic charge build-up when filling an ungrounded fuel container:

- Place approved fuel container on the ground.
- DO NOT fill a fuel container while it is in the vehicle (including the cargo area).
- Keep the fuel pump nozzle in contact with the fuel container while filling.
- DO NOT use a device that would hold the fuel pump handle in the fill position.

Fuel Filler Cap

Your fuel tank filler cap has an indexed design with a 1/4 turn on/off feature.

When fueling your vehicle:

1. Turn the engine off.
2. Carefully turn the filler cap counterclockwise 1/4 of a turn until it stops.
3. Pull to remove the cap from the fuel filler pipe.
4. To install the cap, align the tabs on the cap with the notches on the filler pipe.
5. Turn the filler cap clockwise 1/4 of a turn until it clicks at least once.

304

Maintenance and Specifications

If the digital display reads “CHECK FUEL CAP” and stays on after you start the engine, the fuel filler cap may not be properly installed. Turn off the engine, remove the fuel filler cap, align the cap properly and reinstall it.

A rectangular box with a black border containing the text "CHECK FUELCAP" in a stylized, uppercase font.

If you must replace the fuel filler cap, replace it with a fuel filler cap that is designed for your vehicle. The customer warranty may be void for any damage to the fuel tank or fuel system if the correct genuine Ford or Motorcraft fuel filler cap is not used.

 The fuel system may be under pressure. If the fuel filler cap is venting vapor or if you hear a hissing sound, wait until it stops before completely removing the fuel filler cap. Otherwise, fuel may spray out and injure you or others.

 If you do not use the proper fuel filler cap, excessive vacuum in the fuel tank may damage the fuel system or cause the fuel cap to disengage in a collision, which may result in possible personal injury.

FORD RECOMMENDS BP



Choosing the right fuel

If your vehicle is a flexible fuel vehicle (FFV), use only UNLEADED FUEL and FUEL ETHANOL (Ed75–Ed85).

If your vehicle is not a flexible fuel vehicle (FFV), then only use UNLEADED fuel or UNLEADED fuel blended with a maximum of 10% ethyl alcohol. Your vehicle was not designed to run on E85 fuels that are blended with a maximum of 85% ethyl alcohol. Do not use fuel containing methanol. It can damage critical fuel system components.

The use of leaded fuel is prohibited by law and could damage your vehicle.

Maintenance and Specifications

Your vehicle was not designed to use fuel or fuel additives with metallic compounds, including manganese-based additives. Studies indicate that these additives can cause your vehicle's emission control system to deteriorate more rapidly. In Canada, premium grade fuel generally contains more metallic additives than regular grade fuel. We recommend using regular grade fuel. In Canada, many fuels contain metallic additives, but fuels free of such additives may be available; check with your local fuel dealer.

Repairs to correct the effects of using a fuel for which your vehicle was not designed may not be covered by your warranty.

Cleaner air

Ford endorses the use of reformulated "cleaner-burning" gasolines to improve air quality.

Octane recommendations

Do not be concerned if your engine sometimes knocks lightly. However, if it knocks heavily under most driving conditions while you are using fuel with the recommended octane rating, see your authorized dealer to prevent any engine damage.

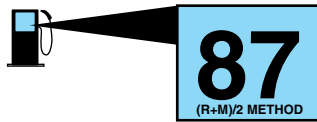

Unleaded Gasoline engines

Your vehicle is designed to use "Regular" unleaded gasoline with an (R+M)/2 octane rating of 87. We do not recommend the use of gasolines labeled as "Regular" that are sold with octane ratings of 86 or lower in high altitude areas.

FFV engine (if equipped)

Your vehicle is designed to use Fuel Ethanol (Ed75–Ed85), "Regular" unleaded gasoline or any mixture of the two fuels.

U.S. government regulations require fuel ethanol dispensing pumps to have a small, square, orange and black label with the common abbreviation or the appropriate percentage for that region. Use of other fuels such as Fuel Methanol may cause powertrain damage, a loss of vehicle performance, and your warranty may be invalidated.

Maintenance and Specifications

Fuel quality

Many of the world's automakers approved the World-wide Fuel Charter that recommends gasoline specifications to provide improved performance and emission control system protection for your vehicle. Gasolines that meet the World-wide Fuel Charter should be used when available. Ask your fuel supplier about gasolines that meet the World-wide Fuel Charter.

Do not add aftermarket fuel additive products to your fuel tank. It should not be necessary to add any aftermarket products to your fuel tank if you continue to use high quality fuel of the recommended octane rating. These products have not been approved for your engine and could cause damage to the fuel system. Repairs to correct the effects of using an aftermarket product in your fuel may not be covered by your warranty.

Unleaded Gasoline engines

If you are experiencing starting, rough idle or hesitation driveability problems during a cold start, try a different brand of "Regular" unleaded gasoline. "Premium" unleaded gasoline is not recommended (particularly in the United States) because it may cause these problems to become more pronounced. If the problems persist, see your authorized dealer.

FFV engine (if equipped)

Your FFV will operate well on ordinary "Regular" unleaded gasoline, but only the highest quality fuel ethanol will provide the same level of protection and performance. To identify if your vehicle is an FFV, check your VIN or the label on the inside of your fuel filler door. When checking the VIN, look for the engine type identifier (8th character). If your vehicle is an FFV, then the character will be labeled as a "V".

If you operate your vehicle 50% or more of the time on ethanol, you should follow a different maintenance schedule. See the *Scheduled Maintenance Guide* for more information.

If you are experiencing a rough or rolling idle after start-up with the outside temperature above 80° F (27° C), the idle should improve within 10 to 30 seconds. If the problems persist below this temperature, see your authorized dealer.

Running out of fuel

Avoid running out of fuel because this situation may have an adverse effect on powertrain components.

Maintenance and Specifications

If you have run out of fuel:

- You may need to cycle the ignition from OFF to ON several times after refueling to allow the fuel system to pump the fuel from the tank to the engine. On restarting, cranking time will take a few seconds longer than normal.
- Normally, adding one gallon of fuel is enough to restart the engine. If the vehicle is out of fuel and on a steep grade, more than one gallon may be required.
- The  indicator may come on. For more information on the “check engine” or the “service engine soon” indicator, refer to *Warning lights and chimes* in the *Instrument Cluster* chapter.

ESSENTIALS OF GOOD FUEL ECONOMY

Measuring techniques

Your best source of information about actual fuel economy is you, the driver. You must gather information as accurately and consistently as possible. Fuel expense, frequency of fill-ups or fuel gauge readings are NOT accurate as a measure of fuel economy. We do not recommend taking fuel economy measurements during the first 1,000 miles (1,600 km) of driving (engine break-in period). You will get a more accurate measurement after 2,000 miles-3,000 miles (3,000 km–5,000 km).

Filling the tank

The advertised fuel capacity of the fuel tank on your vehicle is equal to the rated refill capacity of the fuel tank as listed in the *Maintenance product specifications and capacities* section of this chapter.

The advertised capacity is the amount of the indicated capacity and the empty reserve combined. Indicated capacity is the difference in the amount of fuel in a full tank and a tank when the fuel gauge indicates empty. Empty reserve is the small amount of fuel remaining in the fuel tank after the fuel gauge indicates empty.

The amount of usable fuel in the empty reserve varies and should not be relied upon to increase driving range. When refueling your vehicle after the fuel gauge indicates empty, you might not be able to refuel the full amount of the advertised capacity of the fuel tank due to the empty reserve still present in the tank.

For consistent results when filling the fuel tank:

- Turn the engine/ignition switch to the off position prior to refueling, an error in the reading may result if the engine is left running.

Maintenance and Specifications

- Use the same filling rate setting (low — medium — high) each time the tank is filled.
- Allow no more than three automatic click-offs when filling.
- Always use fuel with the recommended octane rating.
- Use a known quality gasoline, preferably a national brand.
- Use the same side of the same pump and have the vehicle facing the same direction each time you fill up.
- Have the vehicle loading and distribution the same every time.

Your results will be most accurate if your filling method is consistent.

Calculating fuel economy

1. Fill the fuel tank completely and record the initial odometer reading (in miles or kilometers).
2. Each time you fill the tank, record the amount of fuel added (in gallons or liters).
3. After at least three to five tank fill-ups, fill the fuel tank and record the current odometer reading.
4. Subtract your initial odometer reading from the current odometer reading.
5. Follow one of the simple calculations in order to determine fuel economy:

Calculation 1: **Divide total miles traveled by total gallons used.**

Calculation 2: **Multiply liters used by 100, then divide by total kilometers traveled.**

Keep a record for at least one month and record the type of driving (city or highway). This will provide an accurate estimate of the vehicle's fuel economy under current driving conditions. Additionally, keeping records during summer and winter will show how temperature impacts fuel economy. In general, lower temperatures give lower fuel economy.

Driving style — good driving and fuel economy habits

Give consideration to the lists that follow and you may be able to change a number of variables and improve your fuel economy.

Habits

- Smooth, moderate operation can yield up to 10% savings in fuel.
- Steady speeds without stopping will usually give the best fuel economy.

Maintenance and Specifications

- Idling for long periods of time (greater than one minute) may waste fuel.
- Anticipate stopping; slowing down may eliminate the need to stop.
- Sudden or hard accelerations may reduce fuel economy.
- Slow down gradually.
- Driving at reasonable speeds (traveling at 55 mph [88 km/h] uses 15% less fuel than traveling at 65 mph [105 km/h]).
- Revving the engine before turning it off may reduce fuel economy.
- Using the air conditioner or defroster may reduce fuel economy.
- You may want to turn off the speed control in hilly terrain if unnecessary shifting between the top gears occurs. Unnecessary shifting of this type could result in reduced fuel economy.
- Warming up a vehicle on cold mornings is not required and may reduce fuel economy.
- Resting your foot on the brake pedal while driving may reduce fuel economy.
- Combine errands and minimize stop-and-go driving.

Maintenance

- Keep tires properly inflated and use only recommended size.
- Operating a vehicle with the wheels out of alignment will reduce fuel economy.
- Use recommended engine oil. Refer to *Maintenance product specifications and capacities* in this chapter.
- Perform all regularly scheduled maintenance items. Follow the recommended maintenance schedule and owner maintenance checks found in *scheduled maintenance information*.

Conditions

- Heavily loading a vehicle or towing a trailer may reduce fuel economy at any speed.
- Carrying unnecessary weight may reduce fuel economy (approximately 1 mpg [0.4 km/L] is lost for every 400 lb [180 kg] of weight carried).
- Adding certain accessories to your vehicle (for example bug deflectors, rollbars/light bars, running boards, ski/luggage racks) may reduce fuel economy.
- To maximize the fuel economy, drive with the tonneau cover installed (if equipped).

310

Maintenance and Specifications

- Using fuel blended with alcohol may lower fuel economy.
- Fuel economy may decrease with lower temperatures during the first 8–10 miles (12–16 km) of driving.
- Driving on flat terrain offers improved fuel economy as compared to driving on hilly terrain.
- Transmissions give their best fuel economy when operated in the top cruise gear and with steady pressure on the gas pedal.
- Four-wheel-drive operation (if equipped) is less fuel efficient than two-wheel-drive operation.
- Close windows for high speed driving.

EPA window sticker

Every new vehicle should have the EPA window sticker. Contact your authorized dealer if the window sticker is not supplied with your vehicle. The EPA window sticker should be your guide for the fuel economy comparisons with other vehicles.

It is important to note the box in the lower left corner of the window sticker. These numbers represent the Range of MPG (L/100 km) expected on the vehicle under optimum conditions. Your fuel economy may vary depending upon the method of operation and conditions.

EMISSION CONTROL SYSTEM

Your vehicle is equipped with various emission control components and a catalytic converter which will enable your vehicle to comply with applicable exhaust emission standards. To make sure that the catalytic converter and other emission control components continue to work properly:

- Use only the specified fuel listed.
- Avoid running out of fuel.
- Do not turn off the ignition while your vehicle is moving, especially at high speeds.
- Have the items listed in *scheduled maintenance information* performed according to the specified schedule.

The scheduled maintenance items listed in *scheduled maintenance information* are essential to the life and performance of your vehicle and to its emissions system.

If other than Ford, Motorcraft or Ford-authorized parts are used for maintenance replacements or for service of components affecting emission control, such non-Ford parts should be equivalent to genuine Ford Motor Company parts in performance and durability.

Maintenance and Specifications



Do not park, idle, or drive your vehicle in dry grass or other dry ground cover. The emission system heats up the engine compartment and exhaust system, which can start a fire.

Illumination of the  indicator, charging system warning light or the temperature warning light, fluid leaks, strange odors, smoke or loss of engine power could indicate that the emission control system is not working properly.





Exhaust leaks may result in entry of harmful and potentially lethal fumes into the passenger compartment.

Do not make any unauthorized changes to your vehicle or engine. By law, vehicle owners and anyone who manufactures, repairs, services, sells, leases, trades vehicles, or supervises a fleet of vehicles are not permitted to intentionally remove an emission control device or prevent it from working. Information about your vehicle's emission system is on the Vehicle Emission Control Information Decal located on or near the engine. This decal identifies engine displacement and gives some tune up specifications.

Please consult your *Warranty Guide* for complete emission warranty information.

On board diagnostics (OBD-II)



Your vehicle is equipped with a computer that monitors the engine's emission control system. This system is commonly known as the On Board Diagnostics System (OBD-II). The OBD-II system protects the environment by ensuring that your vehicle continues to meet government emission standards. The OBD-II system also assists your authorized dealer in properly servicing your vehicle. When the  indicator illuminates, the OBD-II system has detected a malfunction. Temporary malfunctions may cause the  indicator to illuminate. Examples are:

1. The vehicle has run out of fuel—the engine may misfire or run poorly.
2. Poor fuel quality or water in the fuel—the engine may misfire or run poorly.
3. The fuel cap may not have been securely tightened. See *Fuel filler cap* in this chapter.
4. Driving through deep water – the electrical system may be wet.

312

Maintenance and Specifications



These temporary malfunctions can be corrected by filling the fuel tank with good quality fuel, properly tightening the fuel cap or letting the electrical system dry out. After three driving cycles without these or any other temporary malfunctions present, the  indicator should stay off the next time the engine is started. A driving cycle consists of a cold engine startup followed by mixed city/highway driving. No additional vehicle service is required.

If the  indicator remains on, have your vehicle serviced at the first available opportunity. Although some malfunctions detected by the OBD-II may not have symptoms that are apparent, continued driving with the  indicator on can result in increased emissions, lower fuel economy, reduced engine and transmission smoothness, and lead to more costly repairs.

Readiness for Inspection/Maintenance (I/M) testing

Some state/provincial and local governments may have Inspection/Maintenance (I/M) programs to inspect the emission control equipment on your vehicle. Failure to pass this inspection could prevent you from getting a vehicle registration. Your vehicle may not pass the I/M test if the  indicator is on or not working properly (bulb is burned out), or if the OBD-II system has determined that some of the emission control systems have not been properly checked. In this case, the vehicle is considered not ready for I/M testing.

If the  indicator is on or the bulb does not work, the vehicle may need to be serviced. Refer to the On board diagnostics (OBD-II) description in the *Maintenance and Specifications* chapter.

If the vehicle's engine or transmission has just been serviced, or the battery has recently run down or been replaced, the OBD-II system may indicate that the vehicle is not ready for I/M testing. To determine if the vehicle is ready for I/M testing, turn the ignition key to the ON position for 15 seconds without cranking the engine. If the  indicator blinks eight times, it means that the vehicle is not ready for I/M testing; if the  indicator stays on solid, it means that the vehicle is ready for I/M testing.

The OBD-II system is designed to check the emission control system during normal driving. A complete check may take several days. If the vehicle is not ready for I/M testing, the following driving cycle consisting of mixed city and highway driving may be performed:

15 minutes of steady driving on an expressway/highway followed by 20 minutes of stop-and-go driving with at least four 30 second idle periods.

Maintenance and Specifications

Allow the vehicle to sit for at least eight hours without starting the engine. Then, start the engine and complete the above driving cycle. The engine must warm up to its normal operating temperature. Once started, do not turn off the engine until the above driving cycle is complete. If the vehicle is still not ready for I/M testing, the above driving cycle will have to be repeated.

POWER STEERING FLUID

Check the power steering fluid. Refer to the *scheduled maintenance information* for the service interval schedules. If adding fluid is necessary, use MERCON® ATF.

1. Start the engine and let it run until it reaches normal operating temperature (the engine coolant temperature gauge indicator will be near the center of the normal area between H and C).
2. While the engine idles, turn the steering wheel left and right several times.
3. Turn the engine off.
4. Check the fluid level in the reservoir. It should be between the MIN and MAX lines. Do not add fluid if the level is in this range.
5. If the fluid is low, add fluid in small amounts, continuously checking the level until it reaches the range between the MIN and MAX lines. Be sure to put the cap back on the reservoir.

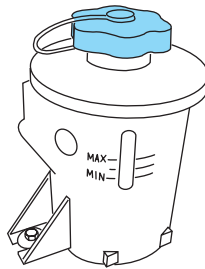

BRAKE FLUID

The fluid level will drop slowly as the brakes wear, and will rise when the brake components are replaced. Fluid levels between the “MIN” and “MAX” lines are within the normal operating range; there is no need to add fluid. If the fluid levels are outside of the normal operating range the performance of the system could be compromised; seek service from your authorized dealer immediately.

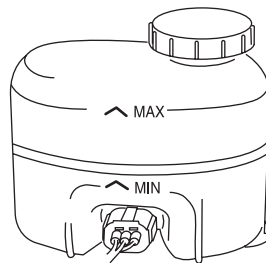

Maintenance and Specifications

CLUTCH FLUID (IF EQUIPPED)

Check the fluid level. Refer to *scheduled maintenance information* for the service interval schedules.

During normal operation, the fluid level in the clutch reservoir should remain constant. If the fluid level drops, refill the fluid level to the step in the reservoir.

Use only a DOT 3 brake fluid designed to meet Ford specifications. Refer to *Maintenance product specifications and capacities* in this chapter.

 Carefully read cautionary information on product label. For **MEDICAL EMERGENCY INFORMATION** contact a physician or Poison Control Center immediately; on Ford-Motorcraft products call: 1-800-959-3673 (FORD). Failure to follow these instructions may result in personal injury.

1. Clean the reservoir cap before removal to prevent dirt and water from entering the reservoir.
2. Remove cap and rubber diaphragm from reservoir.
3. Add fluid until the level reaches the step in the reservoir.
4. Reinstall rubber diaphragm and cap onto reservoir.

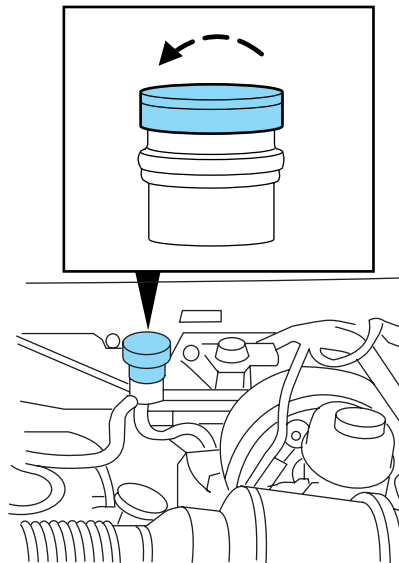

Maintenance and Specifications

TRANSMISSION FLUID

Checking automatic transmission fluid (if equipped)

Refer to your *scheduled maintenance information* for scheduled intervals for fluid checks and changes. Your transmission does not consume fluid. However, the fluid level should be checked if the transmission is not working properly, i.e., if the transmission slips or shifts slowly or if you notice some sign of fluid leakage.

Automatic transmission fluid expands when warmed. To obtain an accurate fluid check, drive the vehicle until it is at normal operating temperature (approximately 20 miles [30 km]). If your vehicle has been operated for an extended period at high speeds, in city traffic during hot weather or pulling a trailer, the vehicle should be turned off for about 30 minutes to allow fluid to cool before checking.

1. Drive the vehicle 20 miles (30 km) or until it reaches normal operating temperature.
2. Park the vehicle on a level surface and engage the parking brake.
3. With the parking brake engaged and your foot on the brake pedal, start the engine and move the gearshift lever through all of the gear ranges. Allow sufficient time for each gear to engage.
4. Latch the gearshift lever in P (Park) and leave the engine running.
5. Remove the dipstick, wiping it clean with a clean, dry lint free rag. If necessary, refer to *Identifying components in the engine compartment* in this chapter for the location of the dipstick.
6. Install the dipstick making sure it is fully seated in the filler tube.
7. Remove the dipstick and inspect the fluid level. The fluid should be in the designated area for normal operating temperature or ambient temperature.

Low fluid level

Do not drive the vehicle if the fluid level is at the bottom of the dipstick and the ambient temperature is above 50°F (10°C).



Correct fluid level

The transmission fluid should be checked at normal operating temperature 150°F-170°F (66°C-77°C) on a level surface. The normal operating temperature can be reached after approximately 20 miles (30 km) of driving.

Maintenance and Specifications

You can check the fluid without driving if the ambient temperature is above 50°F (10°C). However, if fluid is added at this time, an overfill condition could result when the vehicle reaches normal operating temperature.

The transmission fluid should be in this range if at normal operating temperature (150°F-170°F [66°C-77°C]).

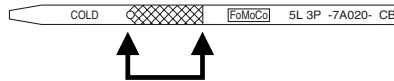

The transmission fluid should be in this range if at ambient temperature (50°F-95°F [10°C-35°C]).

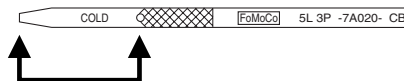

High fluid level

Fluid levels above the safe range may result in transmission failure. An overfill condition of transmission fluid may cause shift and/or engagement concerns and/or possible damage.

High fluid levels can be caused by an overheating condition.

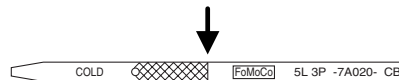

Adjusting automatic transmission fluid levels

Before adding any fluid, make sure the correct type is used. The type of fluid used is normally indicated on the dipstick. Refer to *Maintenance product specifications and capacities* in this chapter.

Use of a non-approved automatic transmission fluid may cause internal transmission component damage.

If necessary, add fluid in 1/2 pint (250 ml) increments through the filler tube until the level is correct.

Maintenance and Specifications

If an overfill occurs, excess fluid should be removed by an authorized dealer.

An overfill condition of transmission fluid may cause shift and/or engagement concerns and/or possible damage.

Do not use supplemental transmission fluid additives, treatments or cleaning agents. The use of these materials may affect transmission operation and result in damage to internal transmission components.

Checking and adding manual transmission fluid (if equipped)

1. Clean the filler plug.

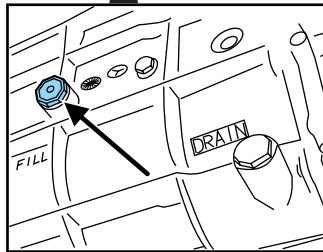
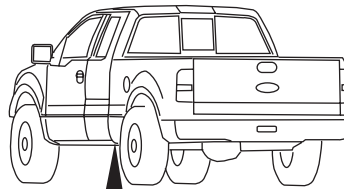
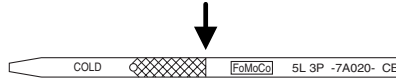

2. Remove the filler plug and inspect the fluid level.

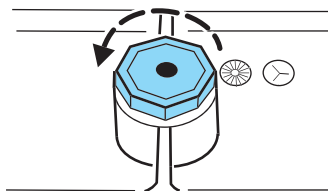

Maintenance and Specifications

3. Fluid level should be at bottom of the opening.
4. Add enough fluid through the filler opening so that the fluid level is at the bottom of the opening.
5. Install and tighten the fill plug securely.

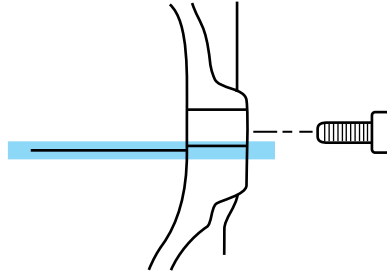

Use only fluid that meets Ford specifications. Refer to the *Maintenance product specifications and capacities* section in this chapter.

TRANSFER CASE FLUID (IF EQUIPPED)

1. Clean the filler plug.
2. Remove the filler plug and inspect the fluid level.

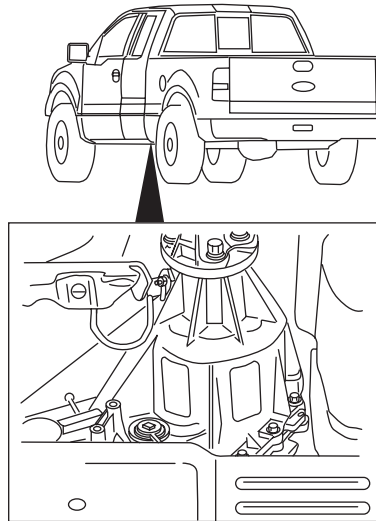

Maintenance and Specifications

3. Add only enough fluid through the filler opening so that the fluid level is at the bottom of the opening.

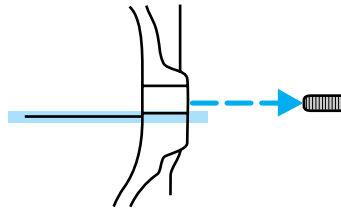

Use only fluid that meets Ford specifications. Refer to the *Maintenance product specifications and capacities* section in this chapter.

DRIVELINE UNIVERSAL JOINT AND SLIP YOKE

Your vehicle may be equipped with universal joints that require lubrication. Refer to the *scheduled maintenance information* for maintenance intervals. If the original universal joints are replaced with universal joints equipped with grease fittings, lubrication will also be necessary.

AIR FILTER

Refer to *scheduled maintenance information* for the appropriate intervals for changing the air filter element.

When changing the air filter element, use only the Motorcraft air filter element listed. Refer to *Motorcraft part numbers* in this chapter.



To reduce the risk of vehicle damage and/or personal burn injuries do not start your engine with the air cleaner removed and do not remove it while the engine is running.

Maintenance and Specifications

Changing the air filter element

• 4.2L/4.6L engines

1. Loosen the clamp that secures the air filter element in place.

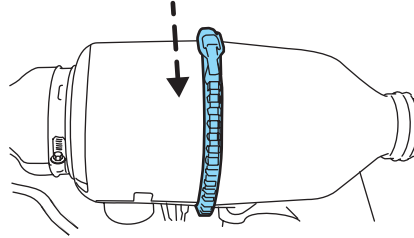

2. Carefully separate the two halves of the air filter housing.

3. Remove the air filter element from the open end of the air filter housing.

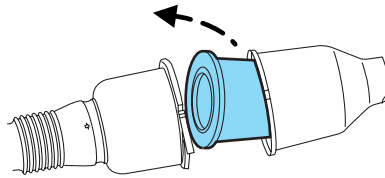

4. Install a new air filter element.

5. Reassemble the two halves of the air filter housing, aligning the notch and slot found on the top of each half. Secure the clamp, making sure not to crimp the air filter edges between the two halves of the air filter housing. This could cause filter damage and allow unmetered air to enter the engine if not properly seated.

• 5.4L Engine

1. Release two retainer clamps.

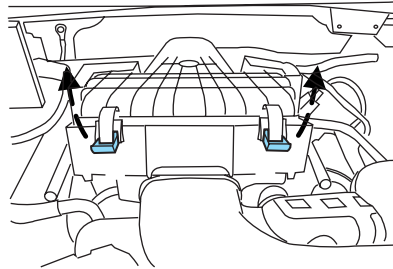

Maintenance and Specifications

2. Pull air filter tray assembly out toward front of vehicle and lift air filter element up and out of housing.

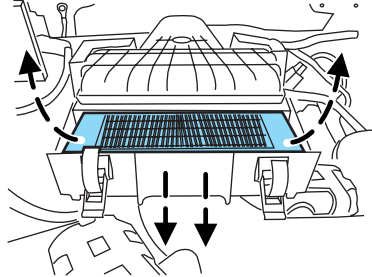

The air filter box needs to be free of any debris before installing a new air filter.

3. Install a new air filter element into the tray assembly.

4. Return air filter tray to original position by pressing firmly on the handle until all rearward movement stops and secure the two clamps.

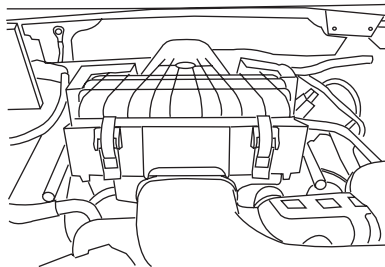

MOTORCRAFT PART NUMBERS

Component	4.2L V6 engine	4.6L V8 engine	5.4L V8 engine
Air filter element	FA-1632	FA-1632	FA-1754
Battery	BTX-59 or BTX-65-650 ³	BTX-59 or BTX-65-650 ³	BTX-59 or BTX-65-650 ³
Fuel Filter	FG-986-B	FG-986-B	FG-986-B
Oil Filter	FL-400-S	FL-820-S	FL-820-S
PCV valve	¹		
Spark plugs	²		

¹The PCV valve is a critical emission component. It is one of the items listed in *scheduled maintenance information* and is essential to the life and performance of your vehicle and to its emissions system.

Maintenance and Specifications

For PCV valve replacement, see your authorized dealer. Refer to *scheduled maintenance information* for the appropriate intervals for changing the PCV valve.

Replace the PCV valve with one that meets Ford material and design specifications for your vehicle, such as a Motorcraft or equivalent replacement part. The customer warranty may be void for any damage to the emissions system if such a PCV valve is not used.

²For spark plug replacement, see your authorized dealer. Refer to *scheduled maintenance information* for the appropriate intervals for changing the spark plugs.

Replace the spark plugs with ones that meet Ford material and design specifications for your vehicle, such as Motorcraft or equivalent replacement parts. The customer warranty may be void for any damage to the engine if such spark plugs are not used.

³Heavy-duty battery, if equipped.

Maintenance and Specifications

MAINTENANCE PRODUCT SPECIFICATIONS AND CAPACITIES

Item	Capacity	Ford part name or equivalent	Ford part number / Ford specification
Brake fluid and clutch fluid	Fill to line or step (for clutch) on reservoir	Motorcraft High Performance DOT 3 Motor Vehicle Brake Fluid	PM-1 or PM-1-C / ESA-M6C25-A or WSS-M6C62-A
4.2L engine oil	6.0 quarts (5.7L)	Motorcraft SAE 5W-20 Premium Synthetic Blend Motor Oil (US) Motorcraft SAE 5W-20 Super Premium Motor Oil (Canada) ¹	XO-5W20-QSP (US) CXO-5W20-LSP12 (Canada) / WSS-M2C930-A and API Certification Mark
4.6L engine oil	6.0 quarts (5.7L)		
5.4L engine oil	7.0 quarts (6.6L)		
4.2L engine coolant	17.6 quarts (16.7L)	Motorcraft Premium Gold Engine Coolant (yellow-colored) ²	VC-7-B / WSS-M97B51-A1
4.6L engine coolant	20.5 quarts (19.4L)		
5.4L engine coolant	20.9 quarts (19.8L)		
Cooling system stop leak pellets	—	Motorcraft Cooling System Stop Leak Pellets	VC-6 / WSS-M99B37-B6
Front axle (4X4)	3.7 pints (2.0L)	Motorcraft SAE 80W-90 Premium Rear Axle Lubricant	XY-80W-90-QL / WSP-M2C197-A

Maintenance and Specifications

Item	Capacity	Ford part name or equivalent	Ford part number / Ford specification
Rear 8.8/9.75 inch axle fluid	5.5 pints (2.6L) ³	Motorcraft SAE 75W-140 Rear Synthetic Axle Lubricant ⁵	XY-75W140-QL / WSL-M2C192-A
Rear 10.25 inch axle fluid	6.9 pints (3.3L) ⁴		
Seat tracks	—	Multi-Purpose Grease	XG-4 or XL-5 / ESB-M1C93-B
Transmission /steering/parking brake linkages and pivots, brake and clutch pedal shaft (if equipped)	—	Premium Long-Life Grease	XG-1-C / ESA-M1C75-B
Hinges, latches, striker plates, fuel filler door hinge and door check arm	—	Hinges, latches, striker plates, fuel filler door hinge and door check arm	XG-3-A / ESE-M1C171-A
Power steering fluid	Fill to between MIN and MAX lines on reservoir	Motorcraft MERCON® ATF	XT-2-QDX / MERCON®
Manual transmission fluid	3.75 quarts (3.5L)		
Transfer case fluid (4X4)	2.0 quarts (1.9L) ⁶		
Automatic transmission fluid (4R75E)	13.9 quarts (13.2L) ⁷	Motorcraft MERCON®V ATF ⁸	XT-5-QM / MERCON®V

Maintenance and Specifications

Item	Capacity	Ford part name or equivalent	Ford part number / Ford specification
Windshield washer fluid	4.25 quarts (4.0L)	Motorcraft Premium Windshield Washer Concentrate	ZC-32-A / WSB-M8B16-A2
Fuel tank Reg. Cab 6.5' box / SuperCab 5.5' box	26.0 gallons (98.4L)	—	—
Fuel tank SuperCrew 5.5' box	30 gallons (113.6L)	—	—
Fuel tank SuperCrew 6.5' box	27 gallons (102.2L) Standard 35.7 gallons (135.1L) Optional	—	—
Fuel tank Reg. Cab 8' box / SuperCab 6.5' box / SuperCab 8' box	27 gallons (102.1L) Standard 35.7 gallons (135.1L) Optional	—	—

¹Use of synthetic or synthetic blend motor oil is not mandatory. Engine oil need only meet the requirements of Ford specification WSS-M2C930-A and the API Certification mark.

²Add the coolant type originally equipped in your vehicle.

³Service refill capacity is determined by filling the axle to 1/4-9/16 inch (6-14 mm) below the bottom of the filler hole with the vehicle on a level surface.

Add 4 oz. (118 ml) of Additive Friction Modifier XL-3 or equivalent meeting Ford specification EST-M2C118-A, for complete fill of 8.8 inch and 9.75 inch Traction-Lok axles.

⁴Service refill capacity is determined by filling the axle to the bottom of the filler hole with the vehicle on a level surface.

Maintenance and Specifications

For 10.25 inch Traction-Lok axles, use 6.5 pints (3.1L) of Motorcraft SAE 75W-140 Synthetic Rear Axle Lubricant and 8 oz. (236 ml) of Additive Friction Modifier XL-3 or equivalent meeting Ford Specification EST-M2C118-A.

⁵Your vehicle's rear axle is filled with a synthetic rear axle lubricant and is considered lubricated for life. These lubricants do not need to be checked or changed unless a leak is suspected, service is required or the axle assembly has been submerged in water. The axle lubricant should be changed any time the rear axle has been submerged in water.

⁶Service refill capacity is determined by filling the transfer case to the bottom of the filler hole with the vehicle on a level surface.

⁷Approximate dry fill capacity including transmission fluid cooling system, actual refill capacities will vary based on vehicle application and transmission fluid cooling system (i.e. coolers size, cooling lines, auxiliary cooler capacities). The amount of transmission fluid and fluid level should be set by the indication on the dipstick's normal operating range.

⁸Ensure the correct automatic transmission fluid is used. Transmission fluid requirements are indicated on the dipstick or on the dipstick handle. Check the container to verify the fluid being added is of the correct type. Refer to your *scheduled maintenance information* to determine the correct service interval.

Some transmission fluids may be labeled as dual usage, such as MERCON® and MERCON® V. These dual usage fluids are not to be used in an automatic transmission that requires use of the MERCON® type fluid.

MERCON® and MERCON® V type fluids are not interchangeable. DO NOT mix MERCON® and MERCON® V. Use of a transmission fluid that indicates dual usage (MERCON® and MERCON® V) in an automatic transmission application requiring MERCON® may cause transmission damage. Use of any fluid other than the recommended fluid may cause transmission damage.

Maintenance and Specifications

ENGINE DATA

Engine	4.2L V6 engine	4.6L V8 engine	5.4L V8 engine
Cubic inches	256	281	330
Required fuel	87 octane	87 octane	87 octane or Ethanol (E85) ²
Firing order	1-4-2-5-3-6	1-3-7-2-6-5-4-8	1-3-7-2-6-5-4-8
Ignition system	EDIS	Coil on plug	Coil on plug
Spark plug gap	0.052–0.056 inch (1.32–1.42mm)	0.052–0.056 inch (1.32–1.42mm)	0.040–0.050 inch (1.02–1.28mm) ¹
Compression ratio	9.3:1	9.37:1	9.85:1

¹The 5.4L 3V spark plug gap can't be adjusted.

²5.4L 3V FFV engines only.

Engine drivebelt routing

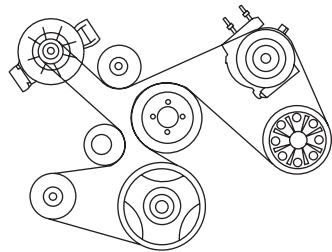

- 4.2L V6 Engine

Maintenance and Specifications

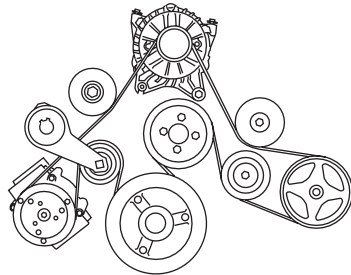

- 4.6L V8 Engine and 5.4L V8 Engine

IDENTIFYING YOUR VEHICLE

Safety Compliance Certification Label

The National Highway Traffic Safety Administration Regulations require that a Safety Compliance Certification Label be affixed to a vehicle and prescribe where the Safety Compliance Certification Label may be located. The Safety Compliance Certification Label is located on the structure (B-Pillar) by the trailing edge of the driver's door or the edge of the driver's door.

MFD. BY FORD MOTOR CO.						
DATE: XX/XX	GVWR: XXXXLB/ XXXXKG					
FRONT GAWR: XXXXL	REAR GAWR: XXXLB					
XXXXKG	WITH	XXXXKG	WITH			
XXXX/XXXXXXX	TIRES	XXXX/XXXXXXX	TIRES			
XXXX XX	RIMS	XXXX XX	RIMS			
AT XXX kPa/XX	PSI COLD	AT XXX kPa/XX	PSI COLD			
THIS VEHICLE CONFORMS TO ALL APPLICABLE FEDERAL MOTOR VEHICLE SAFETY AND THEFT PREVENTION STANDARDS IN EFFECT ON THE DATE OF MANUFACTURE SHOWN ABOVE.						
VIN: XXXXXXXXXXXXXXXXX	XXXXX		XXXXX			
TYPE: XXX						
EXT PNT: XX	RC: XX	DSO:				
WB ¹ BRK	INT TR	TP/PS	R	AXLE	TR SPR	XXXXX
XXX X	XX	X	XX	X XX	XXX	
XXXXXXXXXXXX XXX XXXX-XXXXXX-XX						

Maintenance and Specifications

TRANSMISSION/TRANSAXLE CODE DESIGNATIONS

You can find a transmission/transaxle code on the Safety Compliance Certification Label. The following table tells you which transmission or transaxle each code represents.

MFD. BY FORD MOTOR CO.

DATE: XX/XX GVWR: XXXXXLB/ XXXXXKG
 FRONT GAWR: XXXXL REAR GAWR: XXXXLB
 XXXXKG WITH XXXXKG WITH
 XXXX/XXXXXXXXX TIRES: XXXX/XXXXXXXXX TIRES
 XXXX.XX RIMS: XXXX.XX RIMS
 AT XXX kPa/XX PSI COLD AT XXX kPa/XX PSI COLD

THIS VEHICLE CONFORMS TO ALL APPLICABLE FEDERAL MOTOR VEHICLE SAFETY AND THEFT PREVENTION STANDARDS IN EFFECT ON THE DATE OF MANUFACTURE SHOWN ABOVE.

VIN: XXXXXXXXXXXXXXXXXXXX XXXXX
 TYPE: XXX XXXXX



EXT PNT: XX RC: XX DSO: XXXXX
 WB¹ BRK² INT TR³ TP/PS⁴ R⁵ AXLE⁶ TR⁷ SPR⁸ XXXXX
 XXX X XX X XX X XXX

XXXXXXXXXXXX XX XXXX-XXXXXX-XX

Description	Code
Four-speed automatic (4R75E)	Q
Five-speed manual (M5R2)	M

Accessories

GENUINE FORD ACCESSORIES FOR YOUR VEHICLE

A wide selection of Genuine Ford Accessories are available for your vehicle through your local Ford or Ford of Canada dealer. These quality accessories have been specifically engineered to fulfill your automotive needs; they are custom designed to complement the style and aerodynamic appearance of your vehicle. In addition, each accessory is made from high quality materials and meets or exceeds Ford's rigorous engineering and safety specifications. Ford Motor Company will repair or replace any properly dealer-installed Genuine Ford Accessories found to be defective in factory-supplied materials or workmanship during the warranty period, as well as any component damaged by the defective accessory. The accessories will be warranted for whichever provides you the greatest benefit:

- 12 months or 12,000 miles (20,000 km) (whichever occurs first), or
- the remainder of your new vehicle limited warranty.

This means that Genuine Ford Accessories purchased along with your new vehicle and installed by a dealer are covered for the full length of your New Vehicle's Limited Warranty — 3 years or 36,000 miles (60,000 km) (whichever occurs first). Contact your dealer for details and a copy of the warranty.

Not all accessories are available for all models.

The following is a list of several Genuine Ford Accessories. Not all accessories are available for all models. For a complete listing of the accessories that are available for your vehicle, please contact your dealer or visit our online store at: www.fordaccessoriesstore.com.

Exterior style

Bug shields
Chrome exhaust tips
Deflectors
Exterior trim
Running boards
Splash guards
Step bars
Tonneau covers
Wheels

Interior style

Electrochromatic compass/temperature interior mirrors
Floor mats
Speed control

332

Accessories

Lifestyle

Ash cup / smoker's package

Bedliners and bedmats

Cargo organization and management

Towing mirrors

Trailer hitches, wiring harnesses and accessories

Peace of mind

Mobile-ease[™] hands-free communication system

Remote start

Vehicle security systems

Wheel locks

For maximum vehicle performance, keep the following information in mind when adding accessories or equipment to your vehicle:

- When adding accessories, equipment, passengers and luggage to your vehicle, do not exceed the total weight capacity of the vehicle or of the front or rear axle (GVWR or GAWR as indicated on the Safety Compliance Certification label). Consult your authorized dealer for specific weight information.
- The Federal Communications Commission (FCC) and Canadian Radio Telecommunications Commission (CRTC) regulate the use of mobile communications systems — such as two-way radios, telephones and theft alarms - that are equipped with radio transmitters. Any such equipment installed in your vehicle should comply with FCC or CRTC regulations and should be installed only by a qualified service technician.
- Mobile communications systems may harm the operation of your vehicle, particularly if they are not properly designed for automotive use.
- To avoid interference with other vehicle functions, such as anti-lock braking systems, amateur radio users who install radios and antennas onto their vehicle should not locate the Amateur Radio Antennas in the area of the driver's side hood.
- Electrical or electronic accessories or components that are added to the vehicle by the authorized dealer or the owner may adversely affect battery performance and durability.

Index

A

Accessory delay76
Air cleaner filter320–322
Air conditioning51, 54
Airbag supplemental restraint system140–141
 and child safety seats143
 description141
 disposal145
 driver airbag141, 144
 indicator light145
 operation141, 144
 passenger airbag141, 144
Ambulance packages8
Antifreeze
 (see Engine coolant)295
Anti-lock brake system
 (see Brakes)213
Anti-theft system112
 arming the system113
Armrests117
Audio system
 (see Radio)26, 28, 34
Automatic transmission
 driving an automatic
 overdrive220
 fluid, adding316
 fluid, checking316
 fluid, refill capacities324
 fluid, specification324
Auxiliary Input Jack41
Axle
 lubricant specifications324
 refill capacities324
 traction lok216

B

Battery293

334

acid, treating emergencies293
jumping a disabled battery259
maintenance-free293
replacement, specifications322
servicing293
BeltMinder®135
 deactivating/activating the
 BeltMinder®138
Brakes212
 anti-lock213
 anti-lock brake system (ABS)
 warning light213
 fluid, checking and adding314
 fluid, refill capacities324
 fluid, specifications324
 lubricant specifications324
 parking214
 shift interlock217–218
Bulbs63

C

Capacities for refilling fluids324
Cargo cage99
Cell phone use9
Changing a tire252
Child safety restraints149
 child safety belts149
Child safety seats153
 attaching with tether straps160
 in front seat154, 157
 in rear seat154, 157, 160
Cleaning your vehicle
 engine compartment275
 instrument panel277
 interior279
 interior trim279
 plastic parts276
 safety belts279

Index

- washing273
 - waxing273
 - wheels274
 - wiper blades276
 - Climate control
(see Air conditioning or Heating)48, 51, 54
 - Clock adjust
 - 6-CD in dash35
 - AM/FM Stereo27
 - AM/FM/CD29
 - Clutch
 - fluid315
 - operation while driving223
 - recommended shift speeds224
 - Compass, electronic87, 89
 - calibration89
 - set zone adjustment89–90
 - Console69
 - overhead70
 - Controls
 - power seat117
 - steering column81
 - Coolant
 - checking and adding295
 - refill capacities298, 324
 - specifications324
 - Cruise control
(see Speed control)79
 - Customer Assistance241
 - Ford Extended Service Plan270
 - Getting assistance outside the U.S. and Canada271
 - Getting roadside assistance ...241
 - Getting the service you need266
 - Ordering additional owner's literature272
 - Utilizing the Mediation/Arbitration Program270
- ### D
- Daytime running lamps
(see Lamps)59
 - Dipstick
 - automatic transmission316
 - fluid316
 - engine oil289
 - Driveline universal joint and slip yoke320
 - Driving under special conditions223, 232, 236
 - sand234
 - snow and ice237
 - through water235, 238
 - DVD system47
- ### E
- Electronic message center89
 - Emergencies, roadside
 - jump-starting259
 - Emergency Flashers243
 - Emission control system311
 - Engine328
 - cleaning275
 - coolant295
 - fail-safe cooling299
 - idle speed control293
 - lubrication specifications324
 - refill capacities324
 - service points285–287
 - starting after a collision243
 - Engine block heater212
 - Engine oil289

Index

- checking and adding289
- dipstick289
- filter, specifications292, 322
- recommendations292
- refill capacities324
- specifications324
- Exhaust fumes212
- F**
- Fail safe cooling299
- Flexible Fuel Vehicle (FFV)301
- Floor mats97
- Fluid capacities324
- Foglamps59
- Four-Wheel Drive vehicles227
 - driving off road231
 - electronic shift229–230
 - indicator light227
 - lever operated shift228
 - preparing to drive your vehicle217
- Fuel301
 - calculating fuel economy92, 308
 - cap304
 - capacity324
 - choosing the right fuel305
 - comparisons with EPA fuel economy estimates311
 - detergent in fuel306
 - filling your vehicle with fuel301, 304, 308
 - filter, specifications301, 322
 - fuel pump shut-off switch243
 - improving fuel economy308
 - octane rating306, 328
 - quality307
 - running out of fuel307
 - safety information relating to automotive fuels301
- Fuel - flex fuel vehicle (FFV)301, 305–306
- Fuel pump shut-off switch243
- Fuses244–245
- G**
- Gas cap (see Fuel cap)304
- Gas mileage (see Fuel economy)308
- Gauges19
- H**
- Hazard flashers243
- Head restraints115, 119
- Headlamps58
 - aiming60
 - autolamp system58
 - bulb specifications63
 - daytime running lights59
 - flash to pass59
 - high beam59
 - replacing bulbs64
 - turning on and off58
- Heating
 - heater only system48
 - heating and air conditioning system49, 51, 54
- Homelink wireless control system83
- Hood284
- How to get going22
- I**
- Ignition208, 328

Index

- Illuminated visor mirror69
- Infant seats
(see Safety seats)153
- Inspection/maintenance (I/M)
testing313
- Instrument panel
 cleaning277
 cluster12
 lighting up panel and
 interior60
- J**
- Jack252
 positioning252
 storage252
- Jump-starting your vehicle259
- K**
- Keyless entry system110
 autolock101
 keypad110
 locking and unlocking doors ..111
 programming entry code111
- Keys101, 113
 positions of the ignition208
- L**
- Lamps
 autolamp system58
 bulb replacement
 specifications chart63
 daytime running light59
 fog lamps59
 headlamps58
 headlamps, flash to pass59
 instrument panel, dimming60
 interior lamps62-63
 replacing bulbs64, 67
- Lane change indicator
(see Turn signal)61
- Lights, warning and indicator ...12
 anti-lock brakes (ABS)213
- Load limits188
- Loading instructions194
- Locks
 autolock101
 childproof103
 doors101
- Lubricant specifications324
- Lug nuts259
- Lumbar support, seats117
- M**
- Manual transmission223
 reverse225
- Message center89
 english/metric button93
 system check button93
 warning messages94
- Mirrors77
 automatic dimming rearview
 mirror76
 fold away77
 heated78
 programmable memory106
 side view mirrors (power)77
 signal78
- Moon roof82
- Motorcraft parts281, 301, 322
- N**
- Navigation system47
- O**
- Octane rating306

Index

- Oil (see Engine oil)289
- P**
- Parking brake214
- Parts (see Motorcraft parts)322
- Passenger Occupant
Classification Sensor122
- Power distribution box
(see Fuses)245
- Power door locks101
- Power mirrors77
- Power point72
- Power steering216
fluid, checking and adding314
fluid, refill capacity324
fluid, specifications324
- Power Windows74
- Preparing to drive your
vehicle217
- R**
- Radio26, 28, 34
- Relays244
- Remote entry system104
illuminated entry108
locking/unlocking
doors104–105
panic alarm105
replacement/additional
transmitters107
replacing the batteries106
- Reverse sensing system225
- Roadside assistance241
- S**
- Safety Belt Maintenance139
- Safety belts (see Safety
restraints)121, 124, 126–127,
130–132, 134
- Safety defects, reporting272
- Safety restraints121, 124,
126–127, 130–132, 134
BeltMinder®135
BeltMinder®,
deactivating/activating138
extension assembly139
for adults126–127, 130–132
for children149
lap belt129
Occupant Classification
Sensor122
safety belt maintenance139
warning light and
chime134–135
- Safety seats for children153
- Safety Compliance
Certification Label329
- Satellite Radio Information45
- Seat belts
(see Safety restraints)121
- Seats115
child safety seats153
cleaning280
heated54, 119
memory seat106, 119
- SecuriLock passive anti-theft
system112–113
- Servicing your vehicle283
- Setting the clock
AM/FM stereo27
AM/FM/CD29
AM/FM/In-dash 6 CD35
- Snowplowing8, 238–239

338

Index

- Spark plugs,
specifications322, 328
- Special notice
 ambulance conversions8
 four-wheel drive vehicles240
 utility-type vehicles8
- Specification chart,
lubricants324
- Speed control79
- Starting a flex fuel vehicle211
- Starting your
vehicle208–209, 211
 jump starting259
- Steering wheel
 controls81
 tilting68
- T**
- Tailgate98
- Temperature control
(see Climate control)48
- Tilt steering wheel68
- Tire Pressure Monitoring
System (TPMS)
 Tires, Wheels and Loading184
- Tires169–170, 252
 alignment177
 care173
 changing252, 255
 checking the pressure173
 inflating171
 label183
 replacing175
 rotating177
 safety practices176
 sidewall information178
 snow tires and chains188
 spare tire252
- terminology171
- tire grades170
- treadwear170, 174
- Towing194
 recreational towing206
 trailer towing194
- Traction control215
- Traction-lok rear axle216
- Transfer case
 fluid checking319
- Transmission217
 brake-shift interlock
 (BSI)217–218
 fluid, checking and adding
 (automatic)316
 fluid, checking and adding
 (manual)318
 fluid, refill capacities324
 lubricant specifications324
 manual operation223
- Turn signal61
- V**
- Vehicle Identification Number
(VIN)330
- Vehicle loading188
- Ventilating your vehicle212
- W**
- Warning lights (see Lights)12
- Washer fluid288
- Water, Driving through238
- Windows
 power74
 power down back window75

Index

Windshield washer fluid and wipers	68	checking and adding fluid	288
		replacing wiper blades	288

